



REQUEST FOR SEALED BID PROPOSALS

SJPC 25-E19

ELECTRICAL SUBSTATION

INSPECTIONS, MAINTENANCE, AND REPAIRS

AT THE

BALZANO AND BROADWAY MARINE TERMINALS

SOUTH JERSEY PORT CORPORATION
2 Aquarium Drive, Suite 100
Camden, NJ 08103

Proposal Due Date:
Tuesday, April 15, 2025 at 11:00 AM

TABLE OF CONTENTS

REQUEST FOR PROPOSALS
STATEMENT OF RIGHTS
1.0 INFORMATION FOR PROPOSERS
BACKGROUND PURPOSE AND INTENT
TERM OF CONTRACT
SUBMISSION OF PROPOSALS
PRE-PROPOSAL MEETING (IF APPLICABLE)
QUESTION OR REQUESTS FOR CLARIFICATIONS
ISSUANCE OF ADDENDA
INTERPRETATIONS OF CORRECTIONS BINDING
EQUAL OPPORTUNITY REQUIREMENTS
PROPOSER RESPONSIBILITY
REVIEW OF PROPOSALS
CONTENTS OF PROPOSAL
SIGNATURES
INCURRING COSTS
ACCEPTANCE OF PROPOSALS
AWARD OF CONTRACT
FINAL CONTRACT
DISSEMINATION OF INFORMATION
ECONOMY OF PREPARATION
ORAL PRESENTATION
REVISIONS TO THE REQUEST FOR PROPOSALS
MODIFICATION OR WITHDRAWAL OF A PROPOSAL
SUCCESSFUL PROPOSER RESPONSIBILITIES
ASSIGNMENT
TERMINATION OF CONTRACT
ACCOUNTING RECORDS
CERTIFICATION NON-INVOLVEMENT PROHIBITED IRAN ACTIVITIES
RIGHT OF AUDIT
SOURCE DISCLOSURE
INSURANCE REQUIREMENTS
INDEMNIFICATION
2.0 SCOPE OF SERVICES
3.0 REQUIRED COMPONENTS OF THE PROPOSAL
4.0 SELECTION PROCESS
5.0 CONTRACT AWARD

SJPC 25-E19

REQUEST FOR PROPOSALS

REQUEST FOR SEALED PROPOSALS ELECTRICAL SUBSTATION INSPECTION, MAINTENANCE, AND REPAIR BROADWAY MARINE TERMINAL

Notice is hereby given that sealed Proposals for ELECTRICAL SUBSTATION INSPECTION, MAINTENANCE, AND REPAIR AT THE BROADWAY MARINE TERMINAL, will be received by the South Jersey Port Corporation (hereinafter "SJPC"). Original sealed copies of each firm's Proposal shall be submitted to Alvin Cooley, Senior Purchasing Agent at the South Jersey Port Corporation, 2 Aquarium Drive, Suite 100, Camden, NJ 08103, by **Tuesday, April 15, 2025, at 11:00 AM ET** at which time the sealed Proposals will be opened and recorded.

A Pre-Proposal meeting will be held at the Broadway Marine Terminal, 2500 South Broadway, Camden, NJ, on **Friday, April 4, 2025, at 10:00 am.** Attendance is not mandatory but is strongly recommended. Participants planning to attend the Pre-Proposal Meeting must notify in advance Alvin Cooley, Senior Purchasing Agent, via e-mail, at acooley@southjerseyport.com.

Each Proposal to be considered shall comply with the criteria set forth in the Proposal packets. The Proposal packets may be obtained from SJPC at <http://www.southjerseyport.com> or upon request to: South Jersey Port Corporation, Attention: Alvin Cooley, Senior Purchasing Agent, 2 Aquarium Drive, Suite 100, Camden, NJ 08103, acooley@southjerseyport.com.

Proposers are required to comply with the requirements of N.J.S.A. 10:5-31, et. seq., and N.J.A.C., 17:27 et. seq.

STATEMENT OF RIGHTS

The SJPC reserves, holds, and may at its sole discretion, exercise the following rights and options with respect to this Request for Proposals ("RFP").

1. To select and enter into an agreement with the one or more Proposer(s) based upon experience, qualifications, approach, and other factors specified herein, for the purchase of materials, products, supplies, and non-professional services shall be awarded to the lowest responsible Proposer that submits a responsive Proposal.
2. To reject any and/or all Proposals.
3. To issue additional subsequent solicitations for RFPs and/or amendments to the RFP.
4. To conduct investigations with respect to the qualifications of each Proposer.
5. To negotiate with Proposers for amendments or other modifications to their Proposals.
6. To modify dates.
7. To enter into agreements for only portions (or to not enter into an agreement for any) of the services contemplated by the Proposal submitted.
8. All Proposals prepared in response to this RFP are at the sole expense of the Proposer, and with the express understanding that there will be no claim, whatsoever, for reimbursement from the SJPC for the expense of preparation.
9. The New Jersey Open Public Records Act (hereinafter "OPRA") mandates public access to government records. However, Proposals submitted in response to this RFP may contain technical, financial, or other data whose public disclosure could cause substantial injury to a Proposer's competitive position or constitute a trade secret. To protect these data from disclosure under the OPRA, the Proposer should specifically

identify the pages of the Proposal that contain such information, by properly marking the applicable pages and inserting the following notice in the front of its Proposal.

PROPRIETARY INFORMATION

Proposers are allowed to identify proprietary information and specifically request that such information be used for evaluation purposes only. Proposers should include a statement in their responses that the data on specific pages of their Proposal identified by an asterisk (*) contains technical and/or financial information, which are trade secrets, or information for which disclosure would result in substantial injury to the Proposer's competitive position.

The Proposer, by identifying and requesting that such data be used only for the evaluation of the Proposal, understands that the disclosure will be limited to the extent SJPC considers proper under the OPRA. If an agreement is entered into with the Proposer, SJPC shall have the right to use or disclose the data as provided in the agreement, unless otherwise obligated by law or court order.

The SJPC does not assume any responsibility for disclosure or use of marked data for any purpose. In the event that properly marked data is requested under the OPRA, the Proposer will be advised of the request, and may expeditiously submit to the SJPC a detailed statement indicating the reasons it has for believing that the information is exempt from disclosure under the law. This statement will be used by the SJPC in making its determination as to whether disclosure is proper under the law.

The SJPC has diligently prepared this RFP, and has presented all known, pertinent data as accurately and as completely as possible. This data is provided for general information purposes only. The SJPC does not guarantee or warrant the correctness of this information; moreover, the SJPC accepts no responsibility for any omissions or deletions of information relating to this RFP.

DISCLAIMER

The contents and information provided in this RFP are meant to provide general information to interested parties, and in no way reflect the adherence of the SJPC to any public bidding requirements. The successful Proposer shall be required to execute an agreement with SJPC that will govern the rights, duties and obligations between SJPC and the successful Proposer.

Accordingly, the terms set forth within this RFP do not constitute any contract or agreement between SJPC and the successful Proposer. Moreover, SJPC accepts no responsibility for any omissions or deletions relating to this RFP; however, the successful Proposal and this RFP will become part of the entire agreement to be entered into by SJPC and the successful Proposer.

1.0 INFORMATION FOR PROPOSERS

BACKGROUND, PURPOSE, AND INTENT

The SJPC is an agency of the State of New Jersey with a mission to develop, maintain and operate marine terminals and related intermodal transportation infrastructure within the South Jersey Port District. The agency has primary offices at 2 Aquarium Dr., Suite 100 and port operations at the Balzano Marine Terminal and the Broadway Terminal in Camden, New Jersey. The agency also has facilities in Salem and Paulsboro. SJPC is a grantee of Foreign Trade Zone #142. Additional information may be found by visiting <http://www.southjerseyport.com>

It is the intent of the SJPC to award a contract/contracts to the responsive Proposer(s) whose Proposal conforms to the specifications in the RFP and provides the greatest benefit to the SJPC, when all factors are considered. The successful Proposer will be responsible for all negotiations with the respective authorized suppliers to provide the SJPC with the best price advantage possible.

Proposer(s) responding to this RFP must be on SJPC's pre-qualified engineering list for the engineering discipline services requested; and, should have extensive experience and a knowledgeable background and qualifications in the provision of the services described in this RFP.

In order to be considered for selection, proposals must be received no later than **Tuesday, April 15 at 11:00 AM.**

TERM OF CONTRACT

Following a determination of award by the SJPC, a contract will be entered into with the successful Proposer(s). The contract term shall be for three (3) years with the SJPC's option to extend.

SUBMISSION OF PROPOSALS

Proposals submitted in response to this RFP must contain sufficient detail to allow the SJPC to evaluate the Proposer's experience and qualifications, technical and customer service approach, and cost. The information provided must relate to this specific project.

Sealed Proposals shall be received as required by law.

In order to be considered, three (3) hard copies and one (1) digital copy on USB drive of the Proposal must be submitted in a sealed envelope bearing on the outside the name and address of the Proposer, and the following statement:

"THIS IS A SEALED BID PROPOSAL AND SHALL NOT BE OPENED AND READ UNTIL Tuesday, April 15 at 11:00 AM ET BY SJPC'S SENIOR PURCHASING AGENT, OR HIS/HER DESIGNEE: SJPC-25-E19 ELECTRICAL SUBSTATION INSPECTION, MAINTENANCE, AND REPAIR AT THE BROADWAY MARINE TERMINAL.

Proposals may be mailed, or hand delivered to the SJPC,
and shall be addressed to the attention of:
SOUTH JERSEY PORT CORPORATION
c/o Alvin Cooley, Senior Purchasing Agent
2 Aquarium Drive, Suite 100
Camden, New Jersey 08103

SJPC will not assume responsibility for Proposals not delivered in person to the above address.

In addition to the requested hard copies, please submit an electronic version of your Proposal in a single PDF file on a USB drive.

All Proposals must be received by **Tuesday, April 15 at 11:00 AM**.
No Proposal will be accepted after the specified date and time.

The sealed Proposals will be opened and recorded at SJPC's Corporate Offices located at 2 Aquarium Drive, Suite 100, Camden, NJ 08103. Once Proposals have been opened, they shall remain firm for a period of ninety (90) calendar days from the date of opening.

All prices and amounts must be written in ink or machine printed. Proposals containing any conditions, omissions, unexplained erasures or alteration, items not called for in the Proposal form, attachment of additive information not required by the specifications or irregularities of any kind, may be rejected by SJPC. Any changes, whiteouts, strikeouts, etc., in the Proposal must be initialed in ink by the person signing the Proposal.

Each Proposal form must give the full business address, business phone number, fax number, e-mail address, and contact person of the Proposer, and must be signed by an authorized representative as follows:

- Proposals by partnerships must furnish the full name of all partners and must be signed in the partnership name by one of the members of the partnership or by an authorized representative, followed by the signature and designation of the person signing.
- Proposals by corporations must be signed in the legal name of the corporation, followed by the name of the State in which incorporated and must contain the signature and designation of the president, secretary or other person authorized to bind the corporation in the matter.
- Proposals by sole-proprietorship shall be signed by the proprietor.
- When requested, satisfactory evidence of the authority of the officer signing shall be furnished.

Proposer(s) should be aware of the following statutes that represent "Truth in Contracting" laws:

- N.J.S.A. 2C:21-34 et. seq. governs false claims and representations by Proposers. It is a serious crime for a Proposer to knowingly submit a false claim and/or knowingly make a material misrepresentation.
- N.J.S.A. 2C:27-10 provides that a person commits a crime if said person offers a benefit to a public servant for an official act performed or to be performed by a public servant, which is a violation of official duty.
- N.J.S.A. 2C:27-11 provides that a Proposer commits a crime if said person, directly or indirectly, confers or agrees to confer any benefit allowed by law to a public servant.
- Proposer(s) should consult the statutes or legal counsel for further information and advice.

Proposer(s) are expected to examine the RFP specifications, and all related RFP documents with care and observe all their requirements. Ambiguities, errors, or omissions noted by Proposer(s) should be promptly reported in writing to the appropriate SJPC official. Any prospective Proposer who wishes to challenge an RFP specification shall file such challenges in writing with SJPC no less than three (3) business days prior to the opening of the Proposals. Challenges filed after that time shall not be considered and shall have no impact on SJPC or the award of the contract. In the event the Proposer fails to notify SJPC of such ambiguities, errors, or omissions, the Proposer shall be bound by the requirements of the RFP and the Proposer's submitted Proposal.

PRE-PROPOSAL BID MEETING

A recommended project and/or site review meeting for all potential Proposers for this project will be held at the Broadway Marine Terminal, 2500 South Broadway, Camden, NJ, on **Friday, April 4, 2025 at 10:00 am**. Attendance is not mandatory but is strongly recommended. Failure to attend does not relieve the Proposer of any obligations or requirements.

QUESTIONS OR REQUESTS FOR CLARIFICATION

All questions about the meaning or intent of the RFP documents, including these instructions or the specifications, shall be submitted in writing to the SJPC's Senior Purchasing Agent, Alvin Cooley. The questions or requests for clarification shall be emailed to acooley@southjerseyport.com.

****When submitting a question or request for clarification, the subject line of the email MUST contain the word "Question" followed by the title of the RFP.****

Questions must be received no later than **5:00 PM on Tuesday, April 8, 2025**. Questions received after this date and time may not be answered. Only questions answered by formal written addenda will be binding. Oral and other interpretations or clarifications will be without legal effect.

ISSUANCE OF ADDENDA

Responses to all questions or requests for clarification of a substantive nature will be answered in the form of an addendum. The SJPC shall be the sole judge of the question or request for information's viability. Any informal explanation, clarification, or interpretation will not bind the SJPC, oral or written, by whoever made, that is not incorporated into an addendum.

Notice of Addenda will be issued through the SJPC website at: www.southjerseyport.com/bids. It is the sole responsibility of the Proposer to be knowledgeable of all addenda related to this RFP. The Proposer must complete the "Acknowledgement of Receipt of Addenda" form, which is included in the RFP package, as a required document. Failure to acknowledge receipt of all addenda may render a Proposal as non-responsive.

A Proposer's failure to request a clarification, interpretation, correction or amendment will preclude such Proposer from thereafter claiming any ambiguity, inconsistency or error in the RFP.

INTERPRETATIONS OR CORRECTIONS BINDING

Only questions answered by formal written addenda will be binding, and prospective Proposers are warned that no officer, agent, or other employee of the SJPC, or its representatives, is authorized to give verbal information concerning, explaining or interpreting the RFP.

EQUAL OPPORTUNITY REQUIREMENTS

1. Affirmative Action

Proposers shall be required to comply with all applicable affirmative action and equal employment opportunity laws, orders, rules and regulations including, but not limited to, N.J.S.A. 10:5-31 et. seq., and N.J.A.C. 17:27. The successful Proposer shall be required to submit the applicable Affirmative Action form as required by statute and/or regulation within seven (7) days after receipt by a Proposer of the SJPC's intent to award a contract.

2. Small Business Participation

Policy Statement of the South Jersey Port Corporation

In accordance with Executive Order No. 84 signed by Governor James J. Florio on March 5, 1993 and Executive Order No. 71 signed by Governor James E. McGreevey on October 2, 2003, it is the policy of the SJPC that Small Business Enterprises (“SBE”), as determined and defined by the Department of the Treasury, Division of Revenue and Enterprise Services (“Division of Revenue”) in N.J.A.C. 17:13 et seq., have the opportunity to compete for and participate in the performance of contracts to the purchase of goods and services and for construction services required by the SJPC. The SJPC further requires that its contractors agree to take all necessary and responsible steps, in accordance with the aforementioned regulations, to ensure that SBE’s have these opportunities.

It is the policy of the SJPC that small businesses (each a “small business enterprise” or “SBE”), as determined and defined by the New Jersey Department of the Treasury, Division of Purchase and Property, Contract Compliance and Audit Unit, EEO Monitoring Program (“EEO Monitoring Program”) in N.J.A.C. 17:27 et seq. or other application regulation, should have the opportunity to participate in SJPC contracts.

To the extent the Proposer engages subcontractors or sub-consultants to perform services for the SJPC pursuant to the contract, the Proposer must demonstrate to the SJPC’s satisfaction that a **good faith effort** was made to utilize subcontractors and sub-consultants who are **registered with the EEO Monitoring Program as SBEs**.

Furthermore, Proposers and subcontractors shall be evaluated by the EEO Monitoring Program, based on its attainment of the Participation Goals set forth in N.J.A.C. 17:27-5.2

Please refer to the following link for current applicable procurement target(s) guidelines set forth by the NJ Department of Treasury:

https://www.state.nj.us/treasury/contract_compliance/

Evidence of a “good faith effort” includes, but is not limited to:

1. Whether the Proposer or subcontractor has agreed to make a good faith effort to adhere to targeted minority and women employment goals;
2. Whether the Proposer or subcontractor has met or documented that it has made a good faith effort to meet targeted employment goals;
3. Whether the Proposer or subcontractor has adopted an Equal Employment Opportunity (EEO) Policy;
4. Whether the Proposer or subcontractor has posted an EEO Policy on the job site bulletin board;
5. Whether the Proposer or subcontractor has disseminated the EEO Policy to its workers through various means including company meetings, preconstruction job meetings, written notices, etc.;
6. Whether the Proposer or subcontractor has posted Federal, or State issued EEO posters;
7. Whether the Proposer or subcontractor has identified an EEO Officer and established job duties in writing for such position;
8. Whether the Proposer or subcontractor has developed a basic complaint procedure;
9. Whether the Proposer or subcontractor has knowledge of and has considered the general availability of minorities and women having requisite skills in the immediate labor area;
10. Whether the Proposer or subcontractor has knowledge of and has considered the percentage of minorities and women in the total workforce in the immediate labor area;

11. Whether, when the opportunity has presented itself, the Proposer or subcontractor has considered promoting minority and women employees within its organization;
12. Whether the Proposer or subcontractor attempted to hire minorities and women based upon the anticipated expansion, contraction and turnover of its workforce;
13. Whether the Proposer or subcontractor has the ability to consider undertaking training as a means of making all job classifications available to minorities and women and whether it has done so;
14. Whether the Proposer or subcontractor has utilized the available recruitment resources to attract minorities and women with requisite skills, including, but not limited to, public and private training institutions, job placement services, referral agencies, newspapers, trade papers, faith-based organizations, and community-based organizations;
15. Whether the Proposer or subcontractor has requested qualified minorities and women from a labor union with whom it has an exclusive hiring or referral arrangement;
16. Whether the Proposer or subcontractor has actively recruited beyond the traditional sources to attract minority and women applicants;
17. Whether the Proposer or subcontractor has reviewed all personnel actions to ensure actions are taken in compliance with the company's EEO policy; and
18. Whether the Proposer or subcontractor has retained records of employment and personnel actions and payroll records for a three year-period from the date of the contract or project closing

The successful Proposer agrees to make a good faith effort, if it engages subcontractors, to award at least 25% of the contract to subcontractors registered by the Division of Revenue as an SBE. Subcontracting goals are not applicable if the Proposer is a registered Small Business Enterprise (SBE) firm.

PROPOSER RESPONSIBILITY

The Proposer assumes the sole responsibility for the complete effort required in submitting a Proposal in response to this RFP. No special consideration will be given after Proposals are opened because of a Proposer's failure to be knowledgeable as to all of the requirements of this RFP. The SJPC assumes no responsibility and bears no liability for costs incurred by a Proposer in the preparation and submittal of a Proposal in response to this RFP.

REVIEW OF PROPOSALS

The SJPC, in accordance with law, reserves the right to reject any and all Proposals received in response to this RFP, when determined to be in the SJPC's best interest, and to waive minor noncompliance in a Proposal. The SJPC further reserves the right to make such investigations as it deems necessary as to the qualifications of any and all Proposers submitting Proposals in response to this RFP. In the event that all Proposals are rejected, or if the SJPC at any time deems the number of qualified Proposers receiving designations as the result of this RFP to be insufficient to meet the potential needs of the SJPC, or for any other reason, the SJPC reserves the right to re-solicit Proposals. The SJPC shall not be deemed obligated at any time to award any contract to any Proposer.

CONTENTS OF PROPOSAL

Subsequent to Proposal opening, all information submitted by Proposer(s) in response to this solicitation is considered public information, except as may be exempted from public disclosure by the OPRA, N.J.S.A. 47:1A-1 et. seq., and common law.

A Proposer may designate specific information as not subject to disclosure when the Proposer has a good faith legal/factual basis for such assertion. The SJPC reserves the right to make the determination

concerning such assertion and will advise the Proposer accordingly. The location in the proposal of any such designation should be clearly stated in a cover letter. **THE SJPC WILL NOT HONOR ANY ATTEMPT BY A PROPOSER EITHER TO DESIGNATE ITS ENTIRE PROPOSAL AS PROPRIETARY AND/OR TO CLAIM COPYRIGHT PROTECTION FOR ITS ENTIRE PROPOSAL.** All Proposals, with the exception of information determined by the SJPC or a Court to be proprietary, are available for public inspection after the Notice of Intent to Award is issued to all Proposers. At such time, interested parties can make an appointment with the SJPC to inspect Proposals received in response to this RFP.

SIGNATURES

An officer authorized to make binding commitments for those Proposer's making Proposals shall sign each Proposal.

INCURRING COSTS

Neither the SJPC, nor its consultants, shall be liable for any costs incurred by any Proposers in the preparation of its Proposal for the services requested by this RFP. The SJPC shall not be held liable for any activity or costs associated with the preparation or submission of the Proposal, Proposal conference, oral presentation(s) or any other activity of any kind in regard to and/or related to this RFP.

ACCEPTANCE OF PROPOSALS

The SJPC intends to award a contract to the Proposer or Proposers that the SJPC deems best satisfies the needs of the SJPC and its employees. The RFP does not in any manner or form commit the SJPC to award any contract. The contents of the Proposal may become a contractual obligation if, in fact, the Proposal is accepted, and a contract is entered into with the SJPC. The SJPC may award a contract solely on the basis of the Proposal submitted without any additional negotiations. The SJPC shall reserve all rights to provide for additional negotiations, if it deems in its best interests. Failure of the Proposer to adhere to and/or honor any or all of the obligations of the Proposal may result in immediate cancellation of the award of the contract by the SJPC.

AWARD OF CONTRACT

The SJPC will act to award a contract to the successful Proposer, or reject all Proposals, within ninety (90) calendar days after receipt of the Proposals unless a time extension is obtained by the SJPC in writing signed by the Proposer(s).

FINAL CONTRACT

The contract entered into with the successful Proposer or Proposers shall be a contract that shall be satisfactory in form to the SJPC in accordance with the laws of the State of New Jersey and shall be in the form of the sample professional services agreement that is part of this RFP. It is understood that the contract shall be awarded on the basis of a contract for services or goods within the intent of the statutes and laws of the State of New Jersey.

DISSEMINATION OF INFORMATION

Information included in this document or in any way associated with this RFP is intended for use only for the Proposer and the SJPC and is to remain the property of the SJPC. Under no circumstances shall any of the said information be published, copied or used, except in replying to this RFP.

ECONOMY OF PREPARATION

Proposals should be prepared simply and economically, providing straightforward, concise description of the Proposer's capabilities to satisfy the requirements of the RFP. Emphasis should be on completeness and clarity of content.

ORAL PRESENTATION

Proposers that submit a Proposal in response to this RFP may be required to give an oral presentation of their Proposal to staff and members of the SJPC. This will provide an opportunity for the Proposer to

clarify or elaborate on their Proposal. The SJPC will schedule the time and location of these presentations and notify Proposers accordingly. Requests for oral presentations will not represent any commitment on the part of the SJPC and should not be construed as an intent to award.

REVISIONS TO THE REQUEST FOR PROPOSAL

In the event it becomes necessary for the SJPC to revise any part of the RFP, revisions will be made available in the form of an Addendum and will be issued through the SJPC's website at www.southjerseyport.com/bids. It is the sole responsibility of the Proposer to be knowledgeable of all addenda related to this RFP. If revisions are necessary after conducting the oral presentations, such revisions will only be provided to those Proposers participating in the oral presentations.

MODIFICATION OR WITHDRAWAL OF A PROPOSAL

Proposals may be withdrawn at any time prior to the time specified for the receipt of Proposals by notifying the SJPC Senior Purchasing Agent, Alvin Cooley, via email, at acooley@southjerseyport.com of such a withdrawal. The withdrawal of a proposal does not prejudice the right of the Proposer to file a new Proposal prior to the date and time for the submission of Proposals.

SUCCESSFUL PROPOSER RESPONSIBILITIES

The selected Proposer(s) will be required to assume sole responsibility for the complete effort as required by this RFP. The SJPC will consider the selected Proposer(s) to be the sole point of contact with regard to contractual matters.

ASSIGNMENT

The successful Proposer is prohibited from assigning, transferring, conveying, subletting or otherwise disposing of the agreement entered into with SJPC, or its rights, title or interest therein, or its power to execute such agreement, to any other person, company or corporation without the express written consent of the SJPC.

TERMINATION OF CONTRACT

The SJPC reserves the right to terminate, without reason, a contract entered into as a result of this RFP, provided written notice is given to the successful Proposer in accordance with the termination provisions of the contract.

ACCOUNTING RECORDS

The Proposer selected is required to maintain accounting records and other evidence pertaining to cost incurred regarding the project referenced in the RFP, and to make records available to the SJPC at all reasonable times during the contract period, and for five (5) years from the date of the final payment under the contract, or as provided in the contract, whichever is longer.

CERTIFICATION OF NON-INVOLVEMENT IN PROHIBITED ACTIVITIES IN IRAN

Pursuant to N.J.S.A. 52:32-58, the Proposer must certify that neither the Proposer, nor one of its parents, subsidiaries, and/or affiliates (as defined in N.J.S.A. 52:32-56(e)(3)), is listed on the Department of the Treasury's List of Persons or Entities Engaging in Prohibited Investment Activities in Iran, and that neither is involved in any of the investment activities set forth in N.J.S.A. 52:32-56(f). If the Proposer is unable to so certify, the Proposer shall provide a detailed and precise description of such activities.

RIGHT TO AUDIT

The successful Proposer shall keep and maintain proper and adequate books, records and accounts accurately reflecting all costs and amounts billed to the SJPC with regard to this RFP. The SJPC, its employees, officers, or representatives shall have the right upon written request and reasonable notice, to inspect and examine all books and records related to the successful Proposer's books and records specific to the RFP, Proposal, and agreement. Such records shall be retained by successful Proposer

for at least five (5) years after termination of the contract. In no event shall books and records be disposed of or destroyed prior to five (5) years or during any dispute or claim between the SJPC and the successful Proposer with regard to the RFP/Proposal/Agreement.

In accordance with the New Jersey Office of the State Comptroller (“OSC”) document retention policy at N.J.A.C. 17:44-2.2, the successful Proposer shall maintain all documentation related to the RFP, Proposal and agreement for a period of five (5) years from the date of final payment. Such records shall be made available to the New Jersey Office of the State Comptroller upon request.

SOURCE DISCLOSURE (service contracts only)

Pursuant to N.J.S.A. 52:34-13.2, all services performed under a contract entered with the successful Proposer, or performed under any subcontract awarded under the contract, shall be performed within the United States. Proposers are required to submit the Source Disclosure Form as part of their Proposal. If a service cannot be performed within the United States, the Proposer shall disclose on the Source Disclosure Form the description of services to be performed outside of the United States and the reason why the services cannot be performed within the United States. The SJPC will review the justification and, if the SJPC concludes that the services cannot be performed within the United States, may issue a waiver of this requirement.

PREVAILING WAGE ACT

- A.** The New Jersey Prevailing Wage Act, N.J.S.A. 34: 11-56.25 et seq. is hereby made part of every Contract entered into on behalf of SJPC, except those Contracts which are not within the contemplation of the Act. The Proposer’s signature on this Proposal is their guarantee that neither they nor any subcontractor(s) they might employ to perform the work covered by this Proposal has been suspended or debarred by the Commissioner, Department of Labor and Workforce Development for violation of the provisions of the Prevailing Wage Act and/or the Public Works Vendor Registration Acts; the Proposer’s signature on the Proposal is also their guarantee that they and any subcontractor(s) they might employ to perform the work covered by this proposal shall comply with the provisions of the Prevailing Wage and Public Works Vendor Registration Acts, where required.
- B.** The New Jersey Prevailing Wage Act (N.J.S.A. 34:11-56.25 et seq.) requires that the Department of Labor and Workforce Development establish and enforce a prevailing wage level for workers engaged in public works in order to safeguard their efficiency and general well-being and to protect them as well as their employers from the effects of serious and unfair competition.
- C.** Prevailing wage rates are wage and fringe benefit rates based on the collective bargaining agreements established for a particular craft or trade in the locality in which the public work is performed. In New Jersey, these rates vary by county and by the type of work performed. Applicable prevailing wage rates are those wages and fringe benefits in effect on the date the contract is awarded. All pre-determined rate increases listed at the time the Contract is awarded must also be paid, beginning on the dates specified. Rates that have expired will remain in effect until new rates are posted.

- D. The prevailing wage rate for each craft will list the effective date of the rate and the following information:
1. W = Wage Rate per Hour
 2. B = Fringe Benefit Rate per Hour
 - Fringe benefits are an integral part of the prevailing wage rate. Employers not providing such benefits must pay the fringe benefit amount directly to the employee each payday.
 - Employers providing benefits worth less than the fringe benefit amount must pay the balance directly to the employee each payday.
 - Unless otherwise stated in the Prevailing Wage Rate Determination, the fringe benefit rate for overtime hours remains at the straight time rate.
 3. T = Total Rate per Hour
- E. When the Overtime Notes in the Prevailing Wage Rate Determination state that the overtime rates are "inclusive of benefits," the benefit rate is increased by the same factor as the wage rate (i.e. multiplied by 1.5 for time and one-half, multiplied by 2 for double time, etc.).
- F. Apprentice Rate Schedule An "apprentice" is an individual who is registered with the United States Department of Labor - Office of Apprenticeship and enrolled in a certified apprenticeship program during the period in which they are working on the public works project.
- G. The apprentice wage rate is a percentage of the journeyman wage rate, unless otherwise indicated. The apprentice benefit rate is the full journeyman benefit rate, unless otherwise indicated.
- H. If there is no apprentice rate schedule listed, the individual must be paid at least the journeyman rate even if that individual is in a certified apprentice program for that trade.
- I. If there is no ratio of apprentices to journeymen listed for a particular craft, then the ratio shall be one (1) apprentice to every four (4) journeymen.
- J. The Public Works Vendor Registration Act (N.J.S.A. 34:11-56.48) requires that all vendors, subcontractors, or lower tier subcontractors who are working on or who bid on public works projects register with the Department of Labor and Workforce Development. Applications are available at www.nj.gov/labor (click on Wage & Hour and then go to Registration & Permits).
- K. Pursuant to N.J.S.A. 34:11-56.51: No vendor shall bid on any Contract for public work as defined in section 2 of P.L.1963, c. 150 (C.34:11-56.26) unless the vendor is registered pursuant to this act. No vendor shall list a subcontractor in a Proposal for the Contract unless the subcontractor is registered pursuant to P.L.1999, c.238 (C.34:11-56.48 et seq.) at the time the bid is made. No vendor or subcontractor, including a subcontractor not listed in the Proposal, shall engage in the performance of any public work subject to the Contract, unless the vendor or subcontractor is registered pursuant to that act.

INSURANCE REQUIREMENTS

Prior to commencement of the rendering of services by the successful Proposer, and until completion of the rendition of all services and final payment is made for such services upon final acceptance of same by SJPC, the successful Proposer will provide and maintain the following minimum levels of insurance at the Proposer's own cost and expense. The cost and expense of the required insurance shall be included in the Proposer's response to the RFP, and no adjustment shall be made to the contract price on account of such costs and expenses unless such approval shall be provided in writing by the SJPC. The term Proposer shall include any Subcontractors. Proposer shall furnish Certificates of Insurance evidencing and reflecting the effective date of coverage, as outlined below. In no event shall any services be rendered and/or performed by the successful Proposer until the required evidence of insurance is provided in accordance with this RFP, and same is approved by SJPC. If found to be non-compliant, SJPC may purchase the required insurance coverage(s) and the cost and expense of same will be borne by the successful Proposer through direct payment/reimbursement to SJPC, or SJPC may withhold payment to the successful Proposer for amounts owed to them.

- a) All insurance required by this RFP shall be procured from insurers permitted to do business in the State of New Jersey and have an A.M. Best Rating of at least "A-, Class VIII."
- b) Proposer shall not have a Deductible/Self-Insured Retention (SIR) on any policy greater than \$50,000, which is the responsibility of the Proposer. If Proposer's policy(s) has a Deductible/Self-Insured Retention exceeding this amount, approval must be received from SJPC prior to starting work. In the event any policy includes an SIR, the Proposer is solely responsible for payment within the SIR of their policy(s) and the Additional Insured and Waiver of Rights of Subrogation requirements specified herein shall be provided within the SIR amount(s).
- c) All insurance required herein, with the exception of the Cyber/Privacy Liability & Professional Liability Insurance, shall be written on an "occurrence" basis and not a "claims-made" basis. For Professional Liability "claims-made" coverage must include:
 - i. The retroactive date must be on or prior to the start of work under the successful Proposer's contract; and
 - ii. The successful Proposer must purchase "tail coverage/an extended reporting period" or maintain coverage for a period of three (3) years subsequent to the completion of their work/final payment.
- d) The Proposer's insurance carrier(s) shall agree to provide at least thirty (30) days prior written notice to SJPC in the event coverage is canceled or non-renewed. In the event of cancellation or non-renewal of coverage(s), it is the successful Proposer's responsibility to replace coverage to comply with the contract requirements so there is no lapse of coverage for any time period.

In the event the insurance carriers will not issue or endorse their policy(s) to comply with the above, it shall be the responsibility of the successful Proposer to report any notice of cancellation or non-renewal at least thirty (30) days prior to the effective

date of this notice.

- e) The successful Proposer shall provide SJPC with Certificates of Insurance, evidencing the insurance coverages listed below at least ten (10) days prior to the start of work, and thereafter upon renewal or replacement of each coverage. The successful Proposer shall not begin any work, or render any services, until SJPC has reviewed and approved in writing the said Proposer's Certificate of Insurance. The required insurance shall not contain any exclusions or endorsements which are not acceptable to SJPC.

With respect to insurance maintained after final payment in compliance with the requirement below, an additional certificate(s) evidencing such coverage shall be provided to SJPC with final application for payment, and thereafter upon renewal or replacement of such insurance, until the expiration of the time period for which such insurance must be maintained.

Certificates of Insurance shall be provided to:

Alvin Cooley, Senior Purchasing Agent
South Jersey Port Corporation
2 Aquarium Dr., Suite 100
Camden, NJ 08103
acooley@southjerseyport.com

Failure of SJPC to demand such certificate(s), or other evidence of full compliance with these insurance requirements, or failure of SJPC to identify a deficiency from evidence that is provided, shall not be construed as a waiver of the successful Proposer's obligation to maintain such insurance.

Upon SJPC's written request to broker (with a copy of such request to successful Proposer), successful Proposer hereby agrees and authorizes its insurance broker to provide directly to the SJPC a full and complete copy of all policies of insurance to which SJPC is named as an Additional Insured pursuant to the requirements of this RFP, including all endorsements, exclusions and addendums.

- f) Additional Insured: All liability policies (except Workers' Compensation and Professional Liability Policy, where applicable), shall include an endorsement naming the Indemnified Parties, and following entities, as Additional Insureds (collectively, the "**Additional Insureds**") as follows:

SJPC and any other party whom SJPC is required by contract, permit, and/or agreement to name as Additional Insured are Additional Insureds on a primary and non-contributory basis for ongoing and completed operations. Each of the Additional Insured's respective directors, officers, partners, members, employees, agents and representatives shall also be afforded coverage as Additional Insured.

Additional Insured coverage for the Commercial General Liability and Umbrella/Excess Liability policies must be provided for both ongoing operations and completed operations (using ISO Endorsements CG 20 10 04 13 and CG 20 37 04 13, or their equivalents – in New York State CG 20 38 is required in lieu of CG 20 10) on a primary and non-contributory basis). Coverage should be provided for a period of three (3) years subsequent to the completion of work/final payment.

SJPC reserves the right to require the successful Proposer to name other parties as Additional Insureds, as required by SJPC.

If successful Proposer is operating in a state that has implemented "Anti-Indemnity" Additional Insured Endorsements, you are required to provide the state specific additional insured endorsements for ongoing and completed operations. These states include but are not limited to: Montana, New Mexico, Kansas, Texas, Oklahoma, Georgia, Arizona, and Nebraska.

There shall be no "Insured versus Insured Exclusion" on any policies (other than "Named Insured versus Named Insured"); all policies will provide for "cross liability coverage" as per standard ISO policy forms.

- g) Waiver of Rights of Subrogation: The successful Proposer shall waive all rights of recovery against Owner/Client, SJPC and all Additional Insureds. All policies maintained by the successful Proposer shall include an endorsement waiving rights of recovery in favor of the Additional Insureds described above, as permitted by state law.
- h) A copy of these requirements must be provided by the successful Proposer to any Subcontractors of every tier. The successful Proposer shall require all Subcontractors to provide insurance that is compliant with the requirements of this RFP at a minimum, as well as any additional coverage(s) the said Proposer deems appropriate for its Subcontractors to maintain for the services/work. Proposer is solely responsible for verifying its' Subcontractors compliance with these requirements.
- i) The amount of insurance provided in the required insurance coverage(s) shall not be construed to be a limitation of the liability on the part of the successful Proposer.
- j) The carrying of insurance described herein shall in no way be interpreted as relieving the successful Proposer of any responsibility or liability under its contract with SJPC.
- k) Any type of insurance or any increase in limits of liability not described above which the successful Proposer requires for its own protection, or on account of statute and/or regulation, shall be its own cost and expense. Any insurance coverage maintained by the successful Proposer that exceeds the minimum requirements in this RFP shall be applicable to the services contracted for and rendered.
- l) The successful Proposer shall promptly notify SJPC and the appropriate insurance company(ies) in writing of any accident(s) as well as any claim, suit or process received by the said Proposer arising in the course of operations under the contract. The successful Proposer shall forward such documents received to his insurance company(ies), as soon as practicable, or as required by their insurance policy(ies).

REQUIRED COVERAGES - The following may be provided by the successful Proposer through a combination of primary and excess policies in order to meet the minimum limits set forth below:

Workers' Compensation and Employer's Liability:

Provided in the State in which the work is to be performed, and elsewhere as may be required, and shall include:

- a) Workers' Compensation Coverage: Statutory Requirements
- b) Employers Liability Limits not less than:
 - Bodily Injury by Accident: \$1,000,000 Each Accident
 - Bodily Injury by Disease: \$1,000,000 Each Employee
 - Bodily Injury by Disease: \$1,000,000 Policy Limit
- c) USL&H, Maritime Liability, FELA, and DBA Coverage, if applicable.
- d) Includes coverage for sole proprietors, partners, members, or officers who will be performing the work.
- e) Where applicable, if the successful Proposer is lending or leasing its employees to SJPC for the work under its contract (e.g. crane rental with operator) or the said Proposer leases employees through other payroll, employee management firm, PEO or other company, it is the successful Proposer's responsibility to provide the Workers Compensation and Employer's Liability coverage and to have their policy endorsed with the proper Alternate Employer Endorsement in favor of SJPC.

Commercial General Liability:

Provided on ISO form [CG 00 01](#) 04 13 or an equivalent form including Premises - Operations, Independent Contractors, Products/Completed Operations, Broad Form Property Damage, Contractual Liability, and Personal Injury and Advertising Injury.

- a) Occurrence Form with the following minimum limits:
 - (1) General Aggregate: \$2,000,000
 - (2) Products/Completed Operations Aggregate: \$2,000,000
 - (3) Each Occurrence: \$1,000,000
 - (4) Personal and Advertising Injury: \$1,000,000
- b) Products/Completed Operations Coverage must be maintained for a period of at least three (3) years after final payment / completion of work (including coverage for the Additional Insureds as set forth in these Insurance Requirements).
- c) The General Aggregate Limit must apply on a **Per Project basis**.
- d) No exclusions or limitations to or for the actual work being performed by or on behalf of the Contractor.
- e) No exclusions for residential construction with respect to the work to be completed by or on behalf of the Contractor.
- f) No exclusions or limitations pertaining to the location where the work is being performed.
- g) Amended definition at Occurrence (coverage for work done on your behalf by a

Subcontractor).

- h) No sexual abuse or molestation exclusion.
- i) No assault and battery exclusion.
- j) No amendment to the definition of an “Insured Contract.”
- k) No exclusions or limitations related to Exterior work or the Height of the work.
- l) No Third-Party Action Over, New York Labor Law, or Gravity related exclusions or limitations.
- m) No exclusion for Bodily Injury to an insured’s employee.
- n) No Subcontractor Warranty endorsements.
- o) The definition of an “Insured Contract” must be amended to provide coverage for all work on or within 50 feet of a railroad (CG 24 17 10 01), if applicable. A stand-alone Railroad Protective Liability policy may be required based on the scope of this project.
- p) If this Contract relates to snow removal, a snowplowing operations coverage endorsement (CG 22 92) shall be included to provide completed operations coverage.

Automobile Liability:

- a) Coverage to include All Owned, Hired and Non-Owned Vehicles (or “Any Auto”), if you do not have any Owned Vehicles, you are still required to maintain coverage for Hired and Non-Owned Vehicles as either a stand-alone policy or endorsed onto the Commercial General Liability policy above
- b) Minimum Per Accident Combined Single Limit \$1,000,000
- c) For Proposer(s) involved in the transportation of hazardous material, include the following endorsements: MCS-90 and ISO-9948.

Commercial Umbrella Liability:

- a) Policy(ies) to apply on a Following Form Basis of the following:
 - (1) Commercial General Liability,
 - (2) Automobile Liability, and
 - (3) Employers Liability Coverage.
- b) Minimum Limits of Liability

Trade	Required Umbrella/Excess Limit*
Access Flooring, Acoustical Ceilings, Architectural Woodworking, Carpeting, Ceramic Tile, Fireplaces, Food Service Equipment, Landscaping, Ornamental Metals, Painting & Finishing, Progress Photographs, Resilient Flooring, Roll-Up Doors	\$5,000,000
Carpentry, Drywall & Insulation, Caulking & Sealing, Concrete Work & Foundation, Electrical, Excavation, Glass & Glazing, Granite Façade, HVAC, Masonry, Miscellaneous Iron, Piling, Plumbing, Refuse Chute (Construction)	\$10,000,000
Cranes, Curtain Wall, Demolition, Elevator, Entrances, Elevators, Hoists, Structural Steel, Steel Erection	\$25,000,000
Tower Cranes	\$80,000,000
All Other Subcontractors	\$1,000,000

*Note: the Aggregate Limit must follow the form of the underlying Commercial General Liability policy by applying on a per project basis.

Pollution Liability Insurance:

~~(REQUIRED FOR GENERAL CONTRACTORS, CONSTRUCTION MANAGERS, AND ENVIRONMENTAL CONTRACTORS. REQUIRED FOR SUBCONTRACTORS IF DESIGNATED BY THE SUBCONTRACTOR'S SCOPE OF WORK)~~

- a) ~~Covering losses caused by pollution incidents that arise from the operations of the Contractor and /or their subcontractors of any tier.~~
- b) ~~Minimum Limits of Liability:
Occurrence Limit: \$2,000,000
Aggregate Limit: \$2,000,000~~
- e) ~~Insurance to be maintained for the duration of the work and for a period of three (3) years after completion of work/final payment.~~
- d) ~~No Exclusions for Silica, Asbestos, Lead, Polyfluoroalkyl Substances (PFAS).~~
- e) ~~Include Mold Coverage for full policy limit of liability.~~
- f) ~~Shall include coverage for all pollutants as defined under the Resource Conservation and Recovery Act, as amended, 42 U.S.C. Section 6901 et. Seq. ("RCRA") or any related state or city environmental statute or the removal of any petroleum contaminated material at the project.~~
- g) ~~All owned and/or 3rd Party disposal facilities must be licensed and maintain pollution liability~~

~~insurance of not less than \$2,000,000, if applicable.~~

Professional Liability Insurance:

(REQUIRED FOR GENERAL CONTRACTORS AND CONSTRUCTION MANAGERS.
REQUIRED FOR SUBCONTRACTORS IF DESIGNATED BY THE SUBCONTRACTOR'S
SCOPE OF WORK)

- a) Minimum Limits of Liability
 - Per Claim Limit: \$2,000,000
 - Aggregate Limit: \$2,000,000

- b) The Definition of "Covered Services" shall include the services required in the scope of this contract.

- c) Coverage shall be extended to cover "Green Building," if applicable.

Owned, Leased, Rented or Borrowed Equipment:

Contractor shall maintain Property Coverage for:

- a) their owned, leased, rented, or borrowed equipment, tools, trailers, etc.; and

- b) include a Waiver of Subrogation in favor of all Additional Insureds.

INDEMNIFICATION

The successful Proposer agrees to indemnify and hold harmless the SJPC, its respective directors, officers, and employees from and against any and all losses, claims, causes of action, damages, liabilities, obligations, penalties, judgements, awards, costs expenses and disbursements, including attorneys' fees and other legal expenses and costs, arising directly or indirectly from or in connection with, caused by, relating to, or based upon, any (i) any negligent, careless, reckless, or intentionally wrongful act or omission of the Proposer or Proposer's assistants, employees, contractors, servants or agents, (ii) a determination by a court or agency that the Proposer is not an independent contractor, (iii) any breach by the Proposer, or the Proposer's assistants, employees, contractors, servants or agents of the agreement, (iv) any willful misconduct or gross negligence by the Proposer or the Proposer's assistants, employees, contractors, servants or agents under the agreement, (v) any failure of the Proposer, or the Proposer's assistants, employees, contractors, servants or agents to perform the services in accordance with all applicable laws, rules and regulations; or, (vi) any act by Proposer or the Proposer's assistants, employees contractors, servants, or agents in connection with Proposer's engagement by SJPC that is outside the scope of Proposer's authority hereunder.

This provision shall survive and continue in full force and effect after the expiration or earlier termination of the agreement.

2.0 SCOPE OF SERVICES

See the attached Scope of Work and Exhibit documents.

3.0 REQUIRED COMPONENTS OF THE PROPOSAL

3.1 Overview

Proposers should submit a written response in the form of a Proposal to this RFP. Proposals submitted in response to this RFP shall be of sufficient detail to allow the SJPC to evaluate the Proposer's experience, qualifications, technical approach and cost. The information being provided must relate to the specific services required for this project, as set out in this RFP.

Proposers shall provide as part of their Proposal, the following information:

LETTER OF TRANSMITTAL

SJPC requires that the Proposer include in their Proposal a letter of transmittal, which is not intended to be a summary of the Proposal itself, but must contain the following statements and information:

1. General Information

- a. Company name, address, and telephone number(s) of the Proposer submitting the Proposal.
- b. Name, title, address, e-mail address, and telephone number of the person or persons to contact who are authorized to represent the Proposer and to whom correspondence should be directed.
- c. Federal and state taxpayer identification numbers of the Proposer.
- d. Brief statement of the Proposer's understanding of the services to be performed and a positive commitment to provide the services as specified.
- e. The letter must be signed by a corporate officer or other individual who is legally authorized to bind the Proposer to its Proposal.
- f. General Vendor Information- Please provide the following information:
 - i. Length of time in business of providing proposed services;
 - ii. List 3 other public sector clients;
 - iii. Number of full-time personnel in the organization;
 - iv. Location of headquarters and field offices;
 - v. Location of office which would service this account.

2. Describe how the Proposer is positioned to provide the services listed above, and provide a history of experience in providing similar services.

3. Describe the Proposer's approach to providing these services and its methodology for providing ongoing support.

4. Provide the name, title, address and telephone number of three references for clients to whom the Proposer has provided similar services. Please provide information referencing the actual services provided, customer size (number of users), and the length of tenure providing services to this client.

5. Staff Resources – Identify names of principals and key personnel who will perform the services.

REQUIRED INSURANCE ACKNOWLEDGEMENT

The Proposer shall complete the Required Insurance Acknowledgement and provide a Certificate of Insurance for coverage consistent with the section "Insurance Requirements" or a letter from their insurance company stating their ability to provide a Certificate of Insurance if awarded the contract.

PROPOSAL FORM

The Proposal Form must be complete, with all appropriate signatures and acknowledgement of addenda.

SUBCONTRACTOR DECLARATION

The Proposer shall complete a Subcontractor Declaration and submit with their Proposal a description of contract work they will not be performing within their organization, if any, as outlined in the Subcontractor Declaration.

ACCESS TO TERMINALS – TWIC REQUIREMENT

In accordance with the Maritime Transportation Security Act, all persons requiring unescorted access to restricted SJPC facilities must possess a Transportation Worker Identification Credential (TWIC), issued by the Transportation Security Administration ("TSA"), before such access is granted. Persons seeking access to SJPC facilities who do not physically possess a TWIC may only enter SJPC facilities with an SJPC approved TWIC escort as a side-by-side companion.

ADDITIONAL PROPOSER RESPONSIBILITIES

The Proposer shall, in response to the SJPC's RFP, also include the following documents.

SEE THE "REQUIRED PROPOSAL DOCUMENT SUBMISSION CHECKLIST" included in this RFP

4.0 SELECTION PROCESS

Method

The SJPC's Proposal Review Committee ("PRC") will consist of individuals from the SJPC who will independently analyze each Proposal. The PRC will analyze how the Proposer's qualifications, experience, professional content and proposed methodology meet the SJPC's needs. Proposals should be prepared simply and economically, providing straightforward, concise description of the Proposer's capabilities to satisfy the requirements of this RFP.

Criteria

It is the policy of the SJPC that the selection of a successful Proposer will be on the basis of its Proposal, demonstrated competence, and on the professional qualifications necessary for the satisfactory performance of the services required. The SJPC will put each Proposal submitted through a process of evaluation to determine responsiveness to all administrative and technical requirements of the RFP. Proposals will be evaluated primarily on cost/cost effectiveness, but the Proposer's qualifications, experience, project approach, and methodology may also be considered when evaluating the responsibility of a Proposer and its Proposal.

The Owner may make such investigation, as is deemed necessary, to determine the ability of the Bidder to perform the work; and the Bidder shall furnish to the Owner all such information and data for this purpose as the Owner may request. The Owner reserves the right to reject any bid if the evidence submitted by, or the investigation of such Bidder fails to satisfy the Owner that such Bidder is properly qualified to carry out the obligations of the Contract, and to complete the work therein contemplated. Conditional bids will not be accepted.

Proposer firms shall have a current accreditation from the InterNational Electrical Testing Association (NETA). <https://www.netaworld.org/home>

The prime contractor shall hold the NETA accreditation and perform more than 51% of the work.

The evaluation criteria used by the PRC are intended to be used to make a recommendation to the SJPC Board of Directors, who will award a contract to the successful Proposer, but who are not bound to use the criteria or to award to a particular Proposer on the basis of the recommendation. Furthermore, the SJPC reserves the right to vary from this procedure, as it determines to be in the SJPC's best interest.

5.0 CONTRACT AWARD

The final award of a contract to the successful Proposer will be based on consideration of all information provided as part of the Proposal, or which may be requested prior to the award.

Upon recommendation of award, the SJPC must seek approval of its governing Board at a regularly scheduled Board meeting. A resolution must be passed by the Board that is subject to the Governor's veto period. Upon expiration of the veto period, the SJPC can then award a contract to the successful Proposer.

**SJPC RFQ 25-E19
ELECTRICAL SUBSTATION
INSPECTIONS, MAINTENANCE, AND REPAIRS
BROADWAY MARINE TERMINAL**

BID FORM

Having carefully examined the Bid Documents, including, but not limited to, the Plans, Drawings, Technical Specifications, and form Agreement for this project, and having examined all conditions affecting the work, the undersigned Bidder proposes to complete the all the work as set forth therein, and to furnish all equipment, supervision, transportation, labor, materials, goods and services required to execute the work in accordance with the Bid Documents, including, but not limited to, the Plans, Drawings, Technical Specifications, and Agreement, for the following Unit Price Costs, unless noted otherwise:

It is understood and agreed that any incidental work necessary to complete the Project in its entirety will be included in the line items, unit prices and lump sum bid, whether the line item or items shall specifically state the nature of the incidental work. The line item or items which the incidental work, and the incidental costs, are included shall be selected by the Bidder. It is also understood and agreed that each line item of work shall include all supervision and personnel costs, markups, and other costs envisioned by the Bidder. In other words, all line item costs bid shall be “all-inclusive”. Therefore, the unit prices to be entered on this Bid Form are obtained by dividing the total cost bid to complete the line item by the quantity shown of the form. The bid shall be determined by adding all line item costs for all Bid Items under Base Bid. This grand total Base Bid Price shall constitute the Lump Sum Base Bid Cost of the Project.

Negotiations for the adjustments of the unit price of any item will be completed only when that item and other work or items affecting its quantity have been completed and the total net change in the quantity of such item can be ascertained with sufficient accuracy to determine if it be eligible for consideration in accordance with the foregoing provisions.

The Bidder must also furnish a price for **all** Optional Bids or Alternates requested, as well as **all** separate unit price items requested. Failure to do so will constitute an incomplete bid, which will be rejected by the South Jersey Port Corporation (“SJPC”).

The Bidder agrees that this bid will be valid and binding for a period of ninety (90) days to allow the SJPC time to evaluate the complete Bid Proposal to allow for the decision. The SJPC’s Engineer, or his designee, will officially notify the Bidder of the acceptance of their bid within ninety (90) days following the bid date pending compliance with delivering the requested documentation.

The undersigned accepts responsibility for having completely examined and understood the intent of the Bid Documents, including, but not limited to, Plans, Drawings, Technical Specifications, and form Agreement to be signed upon award; and, for having fully examined the site of the work; and, for having obtained all pertinent information affecting the work.

Bidder shall provide a lump sum proposal in US dollars to supply all necessary design services, materials, goods, labor, tools, consumables, transportation, watercraft, cranes, supervision, PPE, all materials and material controls, and any temporary facilities as necessary to provide for the complete and functional scope of work as described.

Estimated Time Required to Complete All Work in Calendar Days: 30 Days

This project is scheduled to be performed on a Saturday during a preplanned outage of the substation.

We Acknowledge Receipt of the Following Addenda:

1. ADDENDUM NO. _____ Dated: _____
2. ADDENDUM NO. _____ Dated: _____
3. ADDENDUM NO. _____ Dated: _____
4. ADDENDUM NO. _____ Dated: _____

If no addenda are received, indicate by printing or typing the word “NONE” in the space for first addenda.

Failure to acknowledge all addenda may result in your bid being disqualified.

BID FORM

Equipment	Quan	Tests and Maintenance
Main S&C Switchgear	1	Breakers: Clean, Ductor, Megger, AC HI pot
		Batteries: Clean, Inspect, Voltage Readings
		Bus: Clean, Inspect/Torque connections, Megger, HI pot
		Switchgear: Cleaning and Inspection
Step-down Transformers	2	Doble Power Factor, Exciting Current, Bushing C1/C2 (if applicable), Turns Ratio, Winding Resistance, Insulation Resistance. NOTE: All tests will be performed on as found tap.
4160 Volt Switchgear	1	Clean, Ductor, Megger, AC HI pot. Test Transfer Scheme and PT Circuits
BASE BID		\$
Owner's Allowance for additional work		\$ 50,000
Provide 2400 KW Generation	1	Supply Temp 2400 KW (3000 KVA) of Generation @ 4160 Vac for cold storage warehouse(s) and connect same.
Deduct Alternate		\$

TOTAL LUMP SUM BASE BID PRICE -

(Printed / Written and Numerical)

\$ _____

TOTAL CONTRACT AMOUNT - Base Bid Plus Owner's Allowance and Deduct Alternate.

(Printed / Written and Numerical)

\$ _____

Contractor: _____

Primary Contact Name: _____

Title: _____

Signature: _____

Date: _____

Business Address: _____

Phone No: _____

Email Address: _____

ATTACH PER DIEM RATE SCHEDULE FOR ON-CALL WORK

(Scope of Work Section 1.1. M)



SOUTH JERSEY PORT CORPORATION

GENERAL REQUIRED DOCUMENTS FOR BID AND PROPOSAL PROJECTS

REQUIRED INSURANCE ACKNOWLEDGMENT

I acknowledge I have fully read and understand the insurance requirements as outlined in the Bid Specifications.

Furthermore, I have submitted a Certificate of Insurance or a letter from our company's insurance carrier stating their ability to provide a certificate of insurance if awarded a contract.

(Name of Company)

(Signature of Representative)

(Date)

SUBCONTRACTOR DECLARATION

Each bidder shall set forth in the bid the names and addresses of the subcontractors being utilized for this project and their trade. Failure of the bidder to name said subcontractors will be cause for rejection of the bid.

Our company will **not** be utilizing subcontractors for this project.

Our company will be utilizing subcontractors for this project and have attached a separate sheet with their names, addresses, and trades.

(Name of Company)

(Signature of Representative)

(Date)

REQUIRED PROPOSAL DOCUMENT SUBMISSION CHECKLIST

	GENERAL BID REQUIREMENTS	CHECKLIST
	Bid Security	N/A
	Certificate of Surety/Consent of Surety	N/A
	Letter of Transmittal	<input type="checkbox"/>
	Required Insurance Acknowledgement	<input type="checkbox"/>
	Proposal Form	<input type="checkbox"/>
	Subcontractor Declaration	<input type="checkbox"/>

EXHIBIT #	BID REQUIREMENTS - Q EXHIBITS	CHECKLIST
Q1	Small Business Enterprise Questionnaire	<input type="checkbox"/>
Q2	Mandatory Equal Employment Opportunity "Exhibit A" Language (Goods/Service Contracts – if applicable)	<input type="checkbox"/>
Q3	Mandatory Equal Opportunity "Exhibit B" Language (Construction Contracts -if applicable)*	N/A
Q4	Stockholder Disclosure Certification	<input type="checkbox"/>
Q5	Non-Collusion Affidavit	<input type="checkbox"/>
Q6	Debarred List Affidavit	<input type="checkbox"/>
Q7	EEO/AA Compliance	<input type="checkbox"/>
Q8	Business Registration Certificate	<input type="checkbox"/>
Q9	Set-Off for State Tax	<input type="checkbox"/>
Q11	Source Disclosure Form	<input type="checkbox"/>
Q12	Executive Order #189 Vendor Code of Ethics Affidavit	<input type="checkbox"/>
Q13	Executive Order #117 Two Year Chapter 51 / Vender Certification & Disclosure of Political Contributions	<input type="checkbox"/>
Q14	Executive Order #151 Contract Compliance	<input type="checkbox"/>
Q15	Employee Information Report – Form AA302	<input type="checkbox"/>
Q16	Ownership Disclosure Form (formerly E.O. #134)	<input type="checkbox"/>
Q17	Prevailing Wage Notification	<input type="checkbox"/>
Q18	Public Works Contract Notification	<input type="checkbox"/>
Q19	Buy America Notice	N/A
Q20	Pay to Play	<input type="checkbox"/>
Q21	Disclosure/Certification of Investment Activities in Iran	<input type="checkbox"/>
Q22	NJ Election Law Enforcement Commission (Elec) Affidavit	<input type="checkbox"/>
Q24	Certification of Non-involvement in Prohibited Activities in Russia or Belarus Pursuant to P.I.2022, c.3	N/A
Q25	Allen Act Acknowledgement	<input type="checkbox"/>
Q26	Assurance for Payment of Prevailing Wage	<input type="checkbox"/>
Q27	Confidentiality and Commitment to Defend	<input type="checkbox"/>
Q28	Disclosure of Investigations and Other Actions Involving the Vendor Form	<input type="checkbox"/>
Q29	Macbride Principles Form	<input type="checkbox"/>



SOUTH JERSEY PORT CORPORATION

Q EXHIBITS FOR BID AND PROPOSAL PROJECTS

Small Business Enterprise Questionnaire

South Jersey Port Corporation

FOR INFORMATION PURPOSES

New Jersey’s Small Business Set-Aside Program obligates the South Jersey Port Corporation to make 25% of all purchase for goods and services for small businesses. Firms classified as Small Business Enterprises must be registered with the New Jersey Business Action Center.

Registration instructions can be obtained by visiting the State’s website at:

www.nj.gov/njbusiness/contracting/sbsa/ This is not a Set-Aside bid; however South Jersey Port Corporation requires completion of this form to allow the South Jersey Port Corporation to track its Set-Aside obligations are pursuant to Executive Order #71 of former Governor James E. McGreevey and Executive Order #34 of former Governor John S. Corzine.

The South Jersey Port Corporation requests the following:

Our firm is certified/registered with the State of New Jersey Set-Aside Program. Yes No
(Circle One, attach a copy of the certification and enter certification number below)

Certification # _____

	Check Here
SBE (Small Business Enterprise)	<input type="checkbox"/>
MBE (Minority Business Enterprise)	<input type="checkbox"/>
WBE (Woman Business Enterprise)	<input type="checkbox"/>
None of the Above	<input type="checkbox"/>

If yes, please provide Certification & Documentation of MBE & WBE.

NOTE: The South Jersey Port Corporation, being a body politic, is not subject to municipal, state, or federal taxes.

REQUIRED AFFIRMATIVE ACTION EVIDENCE FOR PROCUREMENT PROFESSIONAL AND SERVICES CONTRACTS

All successful vendors must submit one of the following with seven (7) days of the notice to intent to award:

- 1. A photocopy of their Federal Letter of Affirmative Action Plan Approval
Or
- 2. A photocopy of their Certificate of Employee Information Report
Or
- 3. A completed Affirmative Action Employee Information Report (AA302)

PLEASE COMPLETE THE FOLLOWING QUESTIONNAIRE AS PART OF THE BID PACKAGE IN THE EVENT THAT YOU OR YOUR FIRM IS AWARDED THIS CONTRACT

- 1. Our company has a Federal Letter of Affirmative Action Plan Approval
Yes No
- 2. Our company has a Certificate of Employee Information Report
Yes No
- 3. Our company has neither of the above. Please send Form AA302
(AFFIRMATIVE ACTION EMPLOYEE INFORMATION REPORT)
Check Here

NOTE: This form will be sent only if your company is awarded the bid,

I certify that the above information is correct to the best of my knowledge.

NAME _____
(Please type or print)

SIGNATURE _____

TITLE _____

DATE _____

PHONE NUMBER _____

FAX NUMBER _____

EXHIBIT A

MANDATORY EQUAL EMPLOYMENT OPPORTUNITY LANGUAGE N.J.S.A. 10:5-31 et seq. (P.L.1975, c.127) N.J.A.C. 17:27 et seq.

GOODS, GENERAL SERVICES, AND PROFESSIONAL SERVICES CONTRACTS

During the performance of this contract, the contractor agrees as follows:

The contractor or subcontractor, where applicable, will not discriminate against any employee or applicant for employment because of age, race, creed, color, national origin, ancestry, marital status, affectional or sexual orientation, gender identity or expression, disability, nationality or sex. Except with respect to affectional or sexual orientation and gender identity or expression, the contractor will ensure that equal employment opportunity is afforded to such applicants in recruitment and employment, and that employees are treated during employment, without regard to their age, race, creed, color, national origin, ancestry, marital status, affectional or sexual orientation, gender identity or expression, disability, nationality or sex. Such equal employment opportunity shall include, but not be limited to the following: employment, upgrading, demotion, or transfer; recruitment or recruitment advertising; layoff or termination; rates of pay or other forms of compensation; and selection for training, including apprenticeship. The contractor agrees to post in conspicuous places, available to employees and applicants for employment, notices to be provided by the Public Agency Compliance Officer setting forth provisions of this nondiscrimination clause. The contractor or subcontractor, where applicable will, in all solicitations or advertisements for employees placed by or on behalf of the contractor, state that all qualified applicants will receive consideration for employment without regard to age, race, creed, color, national origin, ancestry, marital status, affectional or sexual orientation, gender identity or expression, disability, nationality or sex.

The contractor or subcontractor will send to each labor union, with which it has a collective bargaining agreement, a notice, to be provided by the agency contracting officer, advising the labor union of the contractor's commitments under this chapter and shall post copies of the notice in conspicuous places available to employees and applicants for employment.

The contractor or subcontractor, where applicable, agrees to comply with any regulations promulgated by the Treasurer pursuant to N.J.S.A. 10:5-31 et seq., as amended and supplemented from time to time and the Americans with Disabilities Act.

The contractor or subcontractor agrees to make good faith efforts to meet targeted county employment goals established in accordance with N.J.A.C. 17:27-5.2.

EXHIBIT A (Cont.)

The contractor or subcontractor agrees to inform in writing its appropriate recruitment agencies including, but not limited to, employment agencies, placement bureaus, colleges, universities, and labor unions, that it does not discriminate on the basis of age, race, creed, color, national origin, ancestry, marital status, affectional or sexual orientation, gender identity or expression, disability, nationality or sex, and that it will discontinue the use of any recruitment agency which engages in direct or indirect discriminatory practices.

The contractor or subcontractor agrees to revise any of its testing procedures, if necessary, to assure that all personnel testing conforms with the principles of job related testing, as established by the statutes and court decisions of the State of New Jersey and as established by applicable Federal law and applicable Federal court decisions.

In conforming with the targeted employment goals, the contractor or subcontractor agrees to review all procedures relating to transfer, upgrading, downgrading and layoff to ensure that all such actions are taken without regard to age, race, creed, color, national origin, ancestry, marital status, affectional or sexual orientation, gender identity or expression, disability, nationality or sex, consistent with the statutes and court decisions of the State of New Jersey, and applicable Federal law and applicable Federal court decisions.

The contractor shall submit to the public agency, after notification of award but prior to execution of a goods and services contract, one of the following three documents:

Letter of Federal Affirmative Action Plan Approval;

Certificate of Employee Information Report; or

Employee Information Report Form AA-302 (electronically provided by the Division and distributed to the public agency through the Division's website at:

http://www.state.nj.us/treasury/contract_compliance

The contractor and its subcontractors shall furnish such reports or other documents to the Division of Purchase & Property, CCAU, EEO Monitoring Program as may be requested by the office from time to time in order to carry out the purposes of these regulations, and public agencies shall furnish such information as may be requested by the Division of Purchase & Property, CCAU, EEO Monitoring Program for conducting a compliance investigation pursuant to N.J.A.C. 17:27-1.1 et seq.

EXHIBIT B

MANDATORY EQUAL EMPLOYMENT OPPORTUNITY LANGUAGE N.J.S.A. 10:5-31 et seq. (P.L.1975, c.127) N.J.A.C. 17:27-1.1 et seq.

CONSTRUCTION CONTRACTS

During the performance of this contract, the contractor agrees as follows:

The contractor or subcontractor, where applicable, will not discriminate against any employee or applicant for employment because of age, race, creed, color, national origin, ancestry, marital status, affectional or sexual orientation, gender identity or expression, disability, nationality or sex. Except with respect to affectional or sexual orientation and gender identity or expression, the contractor will ensure that equal employment opportunity is afforded to such applicants in recruitment and employment, and that employees are treated during employment, without regard to their age, race, creed, color, national origin, ancestry, marital status, affectional or sexual orientation, gender identity or expression, disability, nationality or sex. Such equal employment opportunity shall include, but not be limited to the following: employment, upgrading, demotion, or transfer; recruitment or recruitment advertising; layoff or termination; rates of pay or other forms of compensation; and selection for training, including apprenticeship. The contractor agrees to post in conspicuous places, available to employees and applicants for employment, notices to be provided by the Public Agency Compliance Officer setting forth provisions of this nondiscrimination clause.

The contractor or subcontractor, where applicable will, in all solicitations or advertisements for employees placed by or on behalf of the contractor, state that all qualified applicants will receive consideration for employment without regard to age, race, creed, color, national origin, ancestry, marital status, affectional or sexual orientation, gender identity or expression, disability, nationality or sex.

The contractor or subcontractor will send to each labor union, with which it has a collective bargaining agreement, a notice, to be provided by the agency contracting officer, advising the labor union or worker's representative of the contractor's commitments under this act and shall post copies of the notice in conspicuous places available to employees and applicants for employment.

The contractor or subcontractor, where applicable, agrees to comply with any regulations promulgated by the Treasurer, pursuant to N.J.S.A. 10:5-31 et seq., as amended and supplemented from time to time and the Americans with Disabilities Act.

When hiring or scheduling workers in each construction trade, the contractor or subcontractor agrees to make good faith efforts to employ minority and women workers in each construction trade consistent with the targeted employment goal prescribed by N.J.A.C. 17:27-7.2; provided, however, that the Dept. of LWD, Construction EEO Monitoring Program, may, in its discretion, exempt a contractor or subcontractor from compliance with the good faith procedures prescribed by the following provisions, A, B, and C, as long as the Dept. of LWD, Construction EEO Monitoring Program is satisfied that the contractor or subcontractor is employing workers

EXHIBIT B (Cont.)

provided by a union which provides evidence, in accordance with standards prescribed by the Dept. of LWD, Construction EEO Monitoring Program, that its percentage of active “card carrying” members who are minority and women workers is equal to or greater than the targeted employment goal established in accordance with N.J.A.C. 17:27-7.2. The contractor or subcontractor agrees that a good faith effort shall include compliance with the following procedures:

(A) If the contractor or subcontractor has a referral agreement or arrangement with a union for a construction trade, the contractor or subcontractor shall, within three business days of the contract award, seek assurances from the union that it will cooperate with the contractor or subcontractor as it fulfills its affirmative action obligations under this contract and in accordance with the rules promulgated by the Treasurer pursuant to N.J.S.A. 10:5-31 et. seq., as supplemented and amended from time to time and the Americans with Disabilities Act. If the contractor or subcontractor is unable to obtain said assurances from the construction trade union at least five business days prior to the commencement of construction work, the contractor or subcontractor agrees to afford equal employment opportunities minority and women workers directly, consistent with this chapter. If the contractor’s or subcontractor’s prior experience with a construction trade union, regardless of whether the union ‘has provided said ‘assurances, indicates a significant possibility that the trade union will not refer sufficient minority and women workers consistent with affording equal employment opportunities as specified in this chapter, the contractor or subcontractor agrees to be prepared to provide such opportunities to minority and women workers directly, consistent with this chapter, by complying with the hiring or scheduling procedures prescribed under (B) below; and the contractor or subcontractor further agrees to take said action immediately if it determines that the union is not referring minority and women workers consistent with the equal employment opportunity goals set forth in this chapter.

(B) If good faith efforts to meet targeted employment goals have not or cannot be met for each construction trade by adhering to the procedures of (A) above, or if the contractor does not have a referral agreement or arrangement with a union for a construction trade, the contractor or subcontractor agrees to take the following actions:

(1) To notify the public agency compliance officer, the Dept. of LWD, Construction EEO Monitoring Program, and minority and women referral organizations listed by the Division pursuant to N.J.A.C. 17:27-5.3, of its workforce needs, and request referral of minority and women workers.

(2) To notify any minority and women workers who have been listed with it as awaiting available vacancies;

(3) Prior to commencement of work, to request that the local construction trade union refer minority and women workers to fill job openings, provided the contractor or subcontractor has a referral agreement or arrangement with a union for the construction trade;

EXHIBIT B (Cont.)

(4) To leave standing requests for additional referral to minority and women workers with the local construction trade union, provided the contractor or subcontractor has a referral agreement or arrangement with a union for the construction trade, the State Training and Employment Service and other approved referral sources in the area;

(5) If it is necessary to lay off some of the workers in a given trade on the construction site, layoffs shall be conducted in compliance with the equal employment opportunity and nondiscrimination standards set forth in this regulation, as well as with applicable Federal and State court decisions;

(6) To adhere to the following procedure when minority and women workers apply or are referred to the contractor or subcontractor:

(i) The contractor or subcontractor shall interview the referred minority or women worker.

(ii) If said individuals have never previously received any document or certification signifying a level of qualification lower than that required in order to perform the work of the construction trade, the contractor or subcontractor shall in good faith determine the qualifications of such individuals. The contractor or subcontractor shall hire or schedule those individuals who satisfy appropriate qualification standards in conformity with the equal employment opportunity and non-discrimination principles set forth in this chapter. However, a contractor or subcontractor shall determine that the individual at least possesses the requisite skills, and experience recognized by a union, apprentice program or a referral agency, provided the referral agency is acceptable to the Dept. of LWD, Construction EEO Monitoring Program. If necessary, the contractor or subcontractor shall hire or schedule minority and women workers who qualify as trainees pursuant to these rules. All of the requirements, however, are limited by the provisions of (C) below.

(iii) The name of any interested women or minority individual shall be maintained on a waiting list and shall be considered for employment as described in (i) above, whenever vacancies occur. At the request of the Dept. of LWD, Construction EEO Monitoring Program, the contractor or subcontractor shall provide evidence of its good faith efforts to employ women and minorities from the list to fill vacancies.

(iv) If, for any reason, said contractor or subcontractor determines that a minority individual or a woman is not qualified or if the individual qualifies as an advanced trainee or apprentice, the contractor or subcontractor shall inform the individual in writing of the reasons for the determination, maintain a copy of the determination in its files, and send a copy to the public agency compliance officer and to the Dept. of LWD, Construction EEO Monitoring Program.

(7) To keep a complete and accurate record of all requests made for the referral of workers in any trade covered by the contract, on forms made available by the Dept. of LWD, Construction EEO Monitoring Program and submitted promptly to the Dept. of LWD, Construction EEO Monitoring Program upon request.

EXHIBIT B (Cont.)

(C) The contractor or subcontractor agrees that nothing contained in (B) above shall preclude the contractor or subcontractor from complying with the union hiring hall or apprenticeship policies in any applicable collective bargaining agreement or union hiring hall arrangement, and, where required by custom or agreement, it shall send journeymen and trainees to the union for referral, or to the apprenticeship program for admission, pursuant to such agreement or arrangement. However, where the practices of a union or apprenticeship program will result in the exclusion of minorities and women or the failure to refer minorities and women consistent with the targeted county employment goal, the contractor or subcontractor shall consider for employment persons referred pursuant to (B) above without regard to such agreement or arrangement; provided further, however, that the contractor or subcontractor shall not be required to employ women and minority advanced trainees and trainees in numbers which result in the employment of advanced trainees and trainees as a percentage of the total workforce for the construction trade, which percentage significantly exceeds the apprentice to journey worker ratio specified in the applicable collective bargaining agreement, or in the absence of a collective bargaining agreement, exceeds the ratio established by practice in the area for said construction trade. Also, the contractor or subcontractor agrees that, in implementing the procedures of (B) above, it shall, where applicable, employ minority and women workers residing within the geographical jurisdiction of the union.

After notification of award, but prior to signing a construction contract, the contractor shall submit to the public agency compliance officer and the Dept. of LWD, Construction EEO Monitoring Program an initial project workforce report (Form AA-201) electronically provided to the public agency by the Dept. of LWD, Construction EEO Monitoring Program, through its website, for distribution to and completion by the contractor, in accordance with N.J.A.C. 17:27-7. The contractor also agrees to submit a copy of the Monthly Project Workforce Report once a month thereafter for the duration of this contract to the Dept. of LWD, Construction EEO Monitoring Program, and to the public agency compliance officer.

The contractor agrees to cooperate with the public agency in the payment of budgeted funds, as is necessary, for on-the-job and/or off-the job programs for outreach and training of minorities and women.

(D) The contractor and its subcontractors shall furnish such reports or other documents to the Dept. of LWD, Construction EEO Monitoring Program as may be requested by the Dept. of LWD, Construction EEO Monitoring Program from time to time in order to carry out the purposes of these regulations, and public agencies shall furnish such information as may be requested by the Dept. of LWD, Construction EEO Monitoring Program for conducting a compliance investigation pursuant to N.J.A.C. 17:27-1.1 et seq.

STOCKHOLDER DISCLOSURE CERTIFICATION

Q4

Name of Business:

I certify that the list below contains the names and home addresses of all stockholders holding 10% or more of the issued and outstanding stock of the undersigned.

OR

I certify that no one stockholder owns 10% or more of the issued and outstanding stock of the undersigned.

Check the box that represents the type of business organization:

Partnership

Corporation

Sole Proprietorship

Limited Partnership

Limited Liability Corporation

Limited Liability Partnership

Subchapter S Corporation

Sign and notarize the form below, and, if necessary, complete the stockholder list below.

Stockholders:

Name:	Name:
Home Address:	Home Address:
Name:	Name:
Home Address:	Home Address:
Name:	Name:
Home Address:	Home Address:

Subscribed and sworn before me this ___ day of _____, 20 __.	_____
(Notary Public)	(Affiant)
My Commission expires:	_____
	(Print name & title of affiant)
	(Corporate Seal)

NON-COLLUSION AFFIDAVIT

State of New Jersey

County of _____

SS:

I, _____ residing in _____
(name of affiant) (name of municipality)

in the County of _____ and State of _____

of full age, being duly sworn according to law on my oath depose and say that:

I am _____ of the firm of _____
(title or position) (name of firm)

the bidder making this Proposal for the bid entitled _____,
(title of bid proposal)

and that I executed the said proposal with full authority to do so that said bidder has not, directly or indirectly entered into any agreement, participated in any collusion, or otherwise taken any action in restraint of free, competitive bidding in connection with the above named project; and that all statements contained in said proposal and in this affidavit are true and correct, and made with full knowledge that South Jersey Port Corp. relies upon the truth of the statements contained in said Proposal and in the statements contained in this affidavit in awarding the contract for the said project.

I further warrant that no person or selling agency has been employed or retained to solicit or secure such contract upon an agreement or understanding for a commission, percentage, brokerage, or contingent fee, except bona fide employees or bona fide established commercial or selling agencies maintained by _____.
(name of firm)

Subscribed and sworn to

before me, this day

_____, 2____

Signature

(Type or print name of affiant under signature)

Notary public of

My Commission expires _____

(Seal)

STATE OF NEW JERSEY DEBARRED LIST AFFIDAVIT

I, _____ of the City of _____ in the County of _____ and the State of _____ of full age, being duly sworn according to law on my oath depose that:

I am _____, an officer of the firm of Bid for the above named work, and that I executed the said Bid with full authority to do so; that said bidder at the time of making of this bid is not included on the State of New Jersey, Department of the Treasurer’s List of Debarred, Suspended and Disqualified Bidders and that all statements contained in said Bid and in this Affidavit are true and correct, and made with the full knowledge that the City relies upon the truth of the statements contained in said Bid and in statements contained in the Affidavit in awarding the contract for said work. The undersigned further warrants that should the name of the firm making this bid appear on the State Treasurer’s List of Debarred, Suspended and Disqualified Bidders at any time prior to, and during the life of this Contract, including the Guarantee Period, that the City shall be immediately so notified by the signatory of this Eligibility Affidavit.

The undersigned understands that the firm making the bid as a Contractor is subject to debarment, suspension and / or disqualification in contracting with the State of New Jersey and the Department of Environmental Protection if the Contractor, pursuant to N.J.A.C. 7:1-5.2, commits any of the acts listed therein, and as determined according to applicable law and regulation.

Name of Bidder (Type or Print): _____

Signature of Bidder: _____

Address of Bidder: _____

Name & Title of Affiant: _____

Signature of Affiant: _____

Notarization Section

Subscribed and Sworn before me this _____ day of _____, 20____.

Notary Public

(Seal)

Affirmative Action Evidence for Procurement/Service

Please fill out the following forms AA201 & AA202.

STATE OF NEWJERSEY

DEPARTMENT OF LABOR & WORKFORCE DEVELOPMENT
CONSTRUCTION EEO COMPLIANCE MONITORING PROGRAM

Assignment

Code

FORM AA-201

Revised 11/11

INITIAL PROJECT WORKFORCE REPORT CONSTRUCTION

For instructions on completing the form, go to: https://www.nj.gov/treasury/contract_compliance/documents/pdf/forms/aa201ins.pdf

1. FID NUMBER	2. CONTRACTOR ID NUMBER	5. NAME AND ADDRESS OF PUBLIC AGENCY AWARDDING CONTRACT Name: Address:	
3. NAME AND ADDRESS OF PRIME CONTRACTOR (Name) (Street Address) (City) (State) (Zip Code)		CONTRACT NUMBER DATE OF AWARD DOLLAR AMOUNT OF AWARD	
4. IS THIS COMPANY MINORITY OWNED [] OR WOMAN OWNED []		6. NAME AND ADDRESS OF PROJECT Name: Address: COUNTY	7. PROJECT NUMBER
		8. IS THIS PROJECT COVERED BY A PROJECT LABOR AGREEMENT (PLA)? YES <input type="checkbox"/> NO <input type="checkbox"/>	

9. TRADE OR CRAFT	PROJECTED TOTAL EMPLOYEES				PROJECTED MINORITY EMPLOYEES				PROJECTED PHASE - IN DATE	PROJECTED COMPLETION DATE
	MALE		FEMALE		MALE		FEMALE			
	J	AP	J	AP	J	AP	J	AP		
1. ASBESTOS WORKER										
2. BRICKLAYER OR MASON										
3. CARPENTER										
4. ELECTRICIAN										
5. GLAZIER										
6. HVAC MECHANIC										
7. IRONWORKER										
8. OPERATING ENGINEER										
9. PAINTER										
10. PLUMBER										
11. ROOFER										
12. SHEET METAL WORKER										
13. SPRINKLER FITTER										
14. STEAMFITTER										
15. SURVEYOR										
16. TILER										
17. TRUCK DRIVER										
18. LABORER										
19. OTHER										
20. OTHER										

I hereby certify that the foregoing statements made by me are true. I am aware that if any of the foregoing statements are willfully false, I am subject to punishment.

(Signature)

10. (Please Print Your Name)

(Title)

(Area Code)

(Telephone Number)

(Ext.)

(Date)

State Of New Jersey
Department of Labor & Workforce Development
Construction EEO Compliance Monitoring Program

MONTHLY PROJECT WORKFORCE REPORT - CONSTRUCTION

For instructions on completing the form, go to:

https://www.nj.gov/treasury/contract_compliance/documents/pdf/forms/aa202ins.pdf

1. Name and address of Prime Contractor (NAME)	3. F ID or SS Number	Date of Award
2. Contractor ID Number	4. Reporting Period	5. Public Agency Awarding Contract

6. Name and Location of Project (ADDRESS)	County	7. Project ID Number
--	--------	----------------------

8. CONTRACTOR NAME (LIST PRIME CONTRACTOR WITH SUBS FOLLOWING)	9. PERCENT OF WORK COMPLETED	10. TRADE OR CRAFT	CLASSIFICATION (SEE REVERSE)	11. NUMBER OF EMPLOYEES							12. TOTAL NO. OF MIN. EMP.	13. WORK HOURS				14. % OF WORK HRS				15. CUM. WORK HRS				16. CUM. % OF W/H						
				A. TOTAL	B. BLACK	C. HISPANIC	D. AMERICAN INDIAN	E. ASIAN	F. FEMALES	A. MIN. HOURS		B. FEMALE W/H	A. MIN. HOURS	B. FEMALE W/H	A. TOTAL WORK HOURS	A. % OF MIN. W/H	B. % OF FEMALE W/H	A. MIN. HOURS	B. FEMALE HOURS	A. TOTAL WORK HOURS	A. % OF MIN. W/H	B. % OF FEMALE W/H								
			J																											
			AP																											
			J																											
			AP																											
			J																											
			AP																											
			J																											
			AP																											
			J																											
			AP																											

17. COMPLETED BY (PRINT OR TYPE)

(NAME)	(SIGNATURE)	(TITLE)
(AREA CODE)	(TELEPHONE NUMBER)	(EXT.)
		(DATE)

Sample Certificate of Employee Information Report

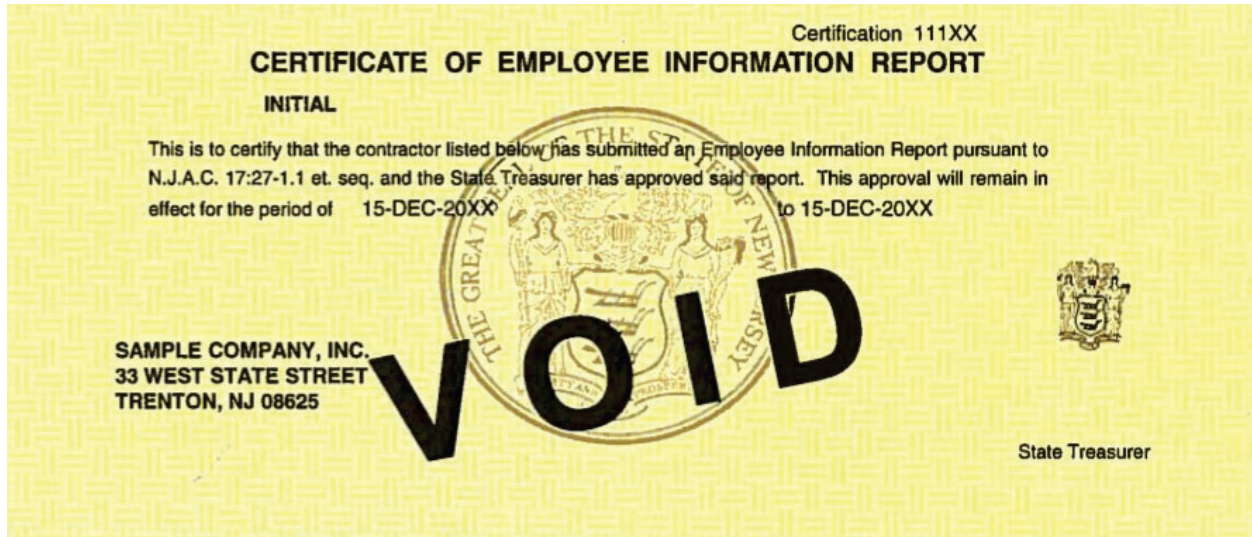

If you are unable to provide your Certificate of Employee Information Report, please fill out the following form and follow the steps.



**STATE OF NEW JERSEY
DEPARTMENT OF THE TREASURY
Division of Purchase & Property, Contract Compliance Audit Unit
EEO Monitoring Program**

DUPLICATE CERTIFICATE OF EMPLOYEE INFORMATION REPORT REQUEST

IMPORTANT - FAILURE TO PROPERLY COMPLETE THE ENTIRE FORM AND SUBMIT THE REQUIRED \$75.00 FEE (Non-Refundable) MAY DELAY ISSUANCE OF YOUR DUPLICATE CERTIFICATE OF EMPLOYEE INFORMATION REPORT.

SECTION A - COMPANY IDENTIFICATION

1. FID. NO. OR SOCIAL SECURITY	2. ASSIGNED CERTIFICATION NUMBER	ISSUE DATE	EXPIRATION DATE
	<input type="text"/>	<input type="text"/>	<input type="text"/>

3. COMPANY NAME

4. STREET	CITY	COUNTY	STATE	ZIP CODE
-----------	------	--------	-------	----------

5. REASON FOR REQUEST OF DUPLICATE CERTIFICATE

1. Lost Certificate 2. Damaged 3. Other (Specify)

SECTION B - SIGNATURE AND IDENTIFICATION

6. NAME OF PERSON COMPLETING FORM (Print or Type)	SIGNATURE	TITLE	DATE MO DAY YEAR
---	-----------	-------	---------------------

7. ADDRESS NO. & STREET	CITY	COUNTY	STATE	ZIP CODE PHONE (AREA CODE, NO., EXTENSION)
-------------------------	------	--------	-------	--

I certify that the information on this Form is true and correct.

SECTION C - OFFICIAL USE ONLY

RECEIVED DATE:		DIVISION OF REVENUE DLN # :	
----------------	--	-----------------------------	--

INSTRUCTIONS FOR COMPLETING DUPLICATE CERTIFICATE REQUEST

ITEM 1 - Enter the Federal Identification Number assigned by the Internal Revenue Service, or if a Federal Employer Identification Number has been applied for, or if your business is such that you have not or will not receive a Federal Employer Identification Number, enter the Social Security Number of the owner or of one partner, in the case of a partnership.

ITEM 2 - Enter the Certificate Number that was assigned to your company along with the Issue Date and Expiration Date (if available).

ITEM 3 - Enter the name by which the company is identified.

ITEM 4 - Enter the physical location of the company. Include City, County, State and Zip Code.

ITEM 5 - Enter the reason for requesting a Duplicate Certificate of Employee Information Report.

ITEM 6 - Print or type the name of the person completing the form. Include the signature, title and date.

ITEM 7 - Enter the physical location where the form is being completed. Include City, State, Zip Code and Phone Number.

RETAIN A COPY OF THIS REQUEST FOR THE VENDOR'S OWN FILES AND FORWARD ONE COPY WITH A CHECK IN THE AMOUNT OF \$75.00 (Non-Refundable Fee) PAYABLE TO "THE TREASURER, STATE OF NEW JERSEY" TO:

**NJ Department of the Treasury
Division of Purchase & Property
Contract Compliance Audit Unit
EEO Monitoring Program
PO Box 206**

Trenton, New Jersey 08625-0206

Telephone No. (609) 292-5473

PLEASE ALLOW 15 BUSINESS DAYS FOR PROCESSING THE DUPLICATE CERTIFICATE

PUBLIC CONTRACT EEO/AA COMPLIANCE PROCEDURES FLOW CHART

EEO/AA Procedures in Awarding Public Contracts

Public Agency

- Include Mandatory Language in advertisements for receipt of bids, solicitation and/or request for proposals.
 - Include appropriate Mandatory Language in contracts and bid specifications.
 - Obtain Required EEO/AA evidence from contractor or vendor.

Vender

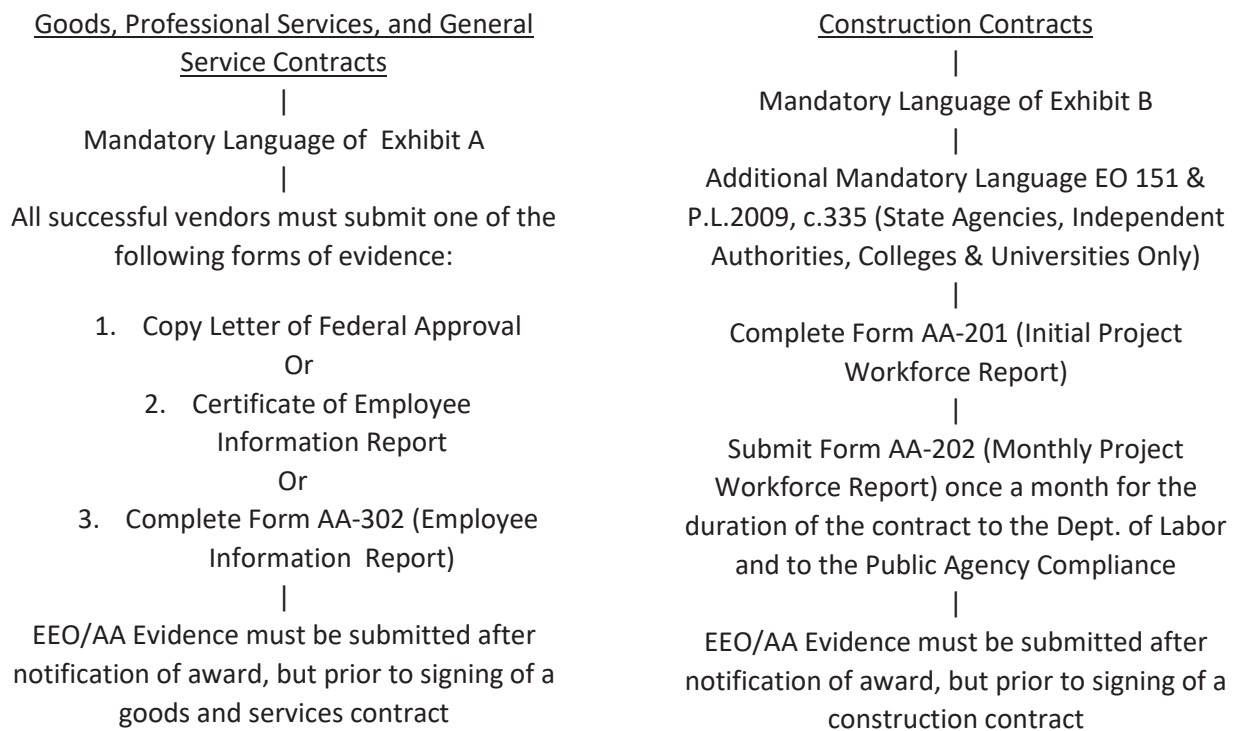

BUSINESS REGISTRATION CERTIFICATE

“Pursuant to the terms of N.J.S.A 52:32-44, all bidders/proposers are required to submit with their bid, proof of valid business registration issued by the Division of Revenue in the Department of Treasure. Failure to submit proof of registration is considered cause for mandatory rejection of bids (a non-waivable defect). No contract shall be entered into by the South Jersey Port Corporation unless the contractor first provides proof of valid business registration. In addition, the successful bidder/proposer is required to receive from any subcontractor it used for services under this contract, proof of valid business registration with an contract with the South Jersey Port Corporation unless the subcontractor first provides proof of valid business registration.”

If you are already registered go to <https://www.state.nj.us/treasury/revenue/busregcert.shtml> to obtain a copy of your Business Registration Certificate.

All question regarding this requirement should be referred to the Division of Revenues
<https://www.state.nj.us/treasury/revenue/revgencode.shtml>

*****PLEASE ATTACH COPY OF YOUR NJ BUSINESS
REGISTRATION CERTIFICATE BELOW*****

NOTICE TO ALL BIDDERS SET-OFF FOR STATE TAX

Please be advised that, pursuant to P.L. 1995, c.159, effective January 1, 1996, and notwithstanding any provision of the law to the contrary, whenever any taxpayer, partnership or S corporation under contract to provide goods or services or construction projects to the State of New Jersey or its agencies or instrumentalities, including the legislative and judicial branches of State government, is entitled to payment for those goods or services at the same time a taxpayer, partner or shareholder of that entity is indebted for any State tax, the Director of the Division of Taxation shall seek to set off that taxpayer's or shareholder's share of the payment due the taxpayer, partnership or S corporation. The amount set off shall not allow for the deduction of any expenses or other deductions which might be attributable to the taxpayer, partner, or shareholder subject to set-off under this act.

The Director of the Division of Taxation shall give notice of the set-off to the taxpayer and provide an opportunity for a hearing within 30 days of such notice under the procedures for protests established under R.S. 54:49-18. No requests for conference, protest, or subsequent appeal to the Tax Court from any protest under this section shall stay the collection of the indebtedness. Interest that may be payable by the State, pursuant to P.L. 1987, c.184 (c. 52:32-32 et seq.), to the taxpayer shall be stayed".

"I HAVE BEEN ADVISED OF THIS NOTICE"

COMPANY: _____

SIGNATURE: _____

NAME: _____

TITLE: _____

DATE: _____

SOURCE DISCLOSURE FORM

BID SOLICITATION # AND TITLE: _____

VENDOR/BIDDER NAME: _____

The Vendor/Bidder submits this Form in response to a Bid Solicitation issued by the South Jersey Port Corporation, in accordance with the requirements of N.J.S.A. 52:34-13.2.

PART 1

- All services will be performed by the Contractor and Subcontractors in the United States. Skip Part 2.
- Services will be performed by the Contractor and/or Subcontractors outside of the United States.
Complete Part 2.

PART 2

Where services will be performed outside of the United States, please list every country where services will be performed by the Contractor and all Subcontractors. If any of the services cannot be performed within the United States, the Contractor shall state, with specificity, the reasons why the services cannot be performed in the United States. The Director of the South Jersey Port Corporation will review this justification and if deemed sufficient, the Director may seek the Treasurer’s approval.

Name of Contractor / Sub-contractor	Performance Location by Country	Description of Service(s) to be Performed Outside of the U.S.	Reason Why the Service(s) Cannot be Performed in the U.S.

**Attach additional sheets if necessary to describe which service(s), if any, will be performed outside of the U.S. and the reason(s) why the service(s) cannot be performed in the U.S.*

Any changes to the information set forth in this Form during the term of any Contract awarded under the referenced Bid Solicitation or extension thereof shall be immediately reported by the Contractor to the Director of the South Jersey Port Corporation. If during the term of the Contract, the Contractor shifts the location of services outside the United States, without a prior written determination by the Director, the Contractor shall be deemed in breach of Contract, and the Contract will be subject to termination for cause. (cont.)

CERTIFICATION

I, the undersigned, certify that I am authorized to execute this certification on behalf of the Vendor/Bidder, that the foregoing information and any attachments hereto, to the best of my knowledge are true and complete. I acknowledge that the South Jersey Port Corporation (SJPC) is relying on the information contained herein, and that the Vendor/Bidder is under a continuing obligation from the date of this certification through the completion of any Contract(s) with the SJPC to notify the SJPC in writing of any changes to the information contained herein; that I am aware that it is a criminal offense to make a false statement or misrepresentation in this certification. If I do so, I will be subject to criminal prosecution under the law, and it will constitute a material breach of my agreement(s) with the SJPC, permitting the SJPC to declare any contract(s) resulting from this certification to be void and unenforceable.

Signature

Date

Print Name and Title

Code of Ethics for Vendors

EXECUTIVE ORDER # 189

The South Jersey Port Corporation considers the maintenance of public trust and confidence essential to its proper functioning, and accordingly has adopted this vendors' Code of Ethics. Vendors who do business with SJPC must avoid all situation where propriety or financial interests, or opportunity for financial gain, could lead to favored treatment for any organization or individual. Vendors must also avoid circumstances and conduct which may constitute actual wrongdoing, or a conflict of interest, but might nevertheless appear questionable to the general public, this compromising the integrity of SJPC.

This code is based upon the principles established in Executive Order 189 and laws governing the Executive Commission on Ethical Standards. N.J.S.A. 52:13D et seq., which, while not strictly applicable to contractors, provides general guidance in this area. Also, this code has been established pursuant to the authority embodied in N.J.S.A. 27:25A et seq., and for good cause.

This Code of Ethics shall be made part of each Request for Proposal (RFP) promulgated by the SJPC and be attached to every contract and agreement to which the SJPC is a party. It shall be distributed to all parties who presently do business with SJPC and, to the extent feasible, to all those parties anticipated doing business with SJPC.

1. No vendor shall employ any SJPC officer or employee in the business of the vendor or professional activity in which the vendor is involved with the SJPC officer or employee.
2. No vendor shall offer or provide an interest, financial or otherwise, direct, or indirect, in the business of the vendor or professional activity in which the vendor is involved with SJPC officer or employee.
3. No vendor shall cause or influence, or attempt to cause or influence any SJPC officer or employee in his or her official capacity in any manner which might tend to impair the objectivity or independence of judgment of the SJPC official or employee.
4. No vendor shall cause or influence, or attempt to cause influence any SJPC officer or employee to use or attempt to use his or her official position to secure an unwarranted privileges or advantages for that vendor or for any other person.

No vendor shall offer any SJPC officer or employees any gifts or favors, service or other thing of value under circumstances from which it might be reasonably inferred that such gift, service or other thing of value was given or offered for purpose of influencing the recipient in the discharge of his or her official duties. In addition, officers, or employees of the SJPC will not be permitted to accept breakfasts, lunches, dinner, alcoholic beverages, tickets to entertainment and/or sporting events or any other item which could be construed having more than nominal value.

NOTE: This section would permit an SJPC officer or employee to accept food or refreshment of relatively low monetary value provided during the course of a meeting, conference or other

occasion where the employee is proper in attendance (for example – coffee, Danish, tea, or soda served during conference break).

Acceptance of unsolicited advertising or promotional material of nominal value (such as inexpensive pens, pencils, or calendars) would be permitted.

Any questions as to what is or is not acceptable or what constitutes proper conduct for an SJPC officer or employee should be referred to the SJPC's Ethic Liaison Officer or his or her designee.

5. This code is intended to augment, not to replace, existing administrative orders and the current SJPC Code of Ethics.

*Vender is defined as any general contractor, subcontractor, consultant, person, firm, corporation, or organization engaging in seeking to do business with the SJPC.

I certify that I have read and understand the aforementioned "Vendor Code of Ethics of the South Jersey Port Corporation".

Vender: _____

Primary Contact & Title: _____

Signature _____

Date: _____

State of New Jersey
Executive Order #151

Governor Jon S. Corzine

WHEREAS, New Jersey is one of the most racially, culturally, and ethnically diverse states in the United States, and this diversity is reflected in the leaders and owners of its businesses, in the leaders and members of the labor movement, and in the employees in every segment of the workforce; and

WHEREAS, the State's business community includes multi-national enterprises, industrial, commercial, and small business sectors; and

WHEREAS, the State's thousands of small businesses, each with fewer than 100 employees, together generate almost 40% of the jobs in the State; and

WHEREAS, small, minority, and women-owned business enterprises have historically been underrepresented in the receipt of State contract awards; and

WHEREAS, the State's workforce provides New Jersey's multinational enterprises, its industrial, commercial, and small business sectors, and its public and not-for-profit sectors with highly educated, highly skilled, and highly motivated employees, who contribute to the prosperity of the State while supporting their families; and

WHEREAS, in response to the current national recession, the United States Congress enacted the American Recovery and Reinvestment Act of 2009 (ARRA), which will increase federal spending at the State and local levels by approximately \$10 billion, and will fully fund certain work in the State, and partially fund other State projects; and

WHEREAS, given the recession and unemployment levels in New Jersey, it is imperative that every sector of the economy be offered the opportunity to benefit from the federal economic recovery funds and the State's own spending; and

WHEREAS, many of the State's businesses have significant public construction contracts and other contracts to provide goods or services to government and many others would like the opportunity to compete for these contracts to expand their businesses while serving the public; and

WHEREAS, residents of the State of New Jersey deserve a government that provides equal opportunity for all contractors to compete to submit winning bids on public contracts; and

WHEREAS, residents of the State of New Jersey, especially during these difficult economic times, deserve a government that does everything it can to expand job opportunities, particularly for men and women who are entering the workforce, who have experienced difficulties entering the workforce, or who have recently become unemployed or underemployed; and

WHEREAS, the State created an internet site, <http://www.recovery.nj.gov>, which outlines the allocation of New Jersey's share of economic recovery funds under the ARRA; and

WHEREAS, to spend ARRA funds transparently and ensure that those seeking work have a fair chance to obtain ARRA-funded employment, State agencies and entities should be required to post all State and

ARRA-funded jobs on the State Job Bank internet site, <http://NJ.gov/JobCentralNJ>, to allow New Jersey residents to identify these employment opportunities; and

WHEREAS, the State must procure its construction services, goods, and other services as efficiently as possible, with transparency in the processing, selection, and awarding of public contracts; and

WHEREAS, robust competition for public contracts ensures that the government of the State of New Jersey obtains the construction services, goods, and other services it needs to perform its vital functions with maximum cost effectiveness; and

WHEREAS, broad and sustained efforts to notify all potential bidders of opportunities to contract with government should be encouraged to promote competition for public contracts, thus benefiting the public fisc; and

WHEREAS, the State of New Jersey commissioned the State of New Jersey Construction Services Disparity Study 2000 – 2002 (October 2005) and the State of New Jersey Disparity Study of Procurement in Professional Services, Other Services, and Goods and Commodities (June 2005), and both studies documented significant disparities between the firms ready, willing, and able to do business with the State, and those firms actually awarded contracts by State departments, agencies, authorities, colleges, and universities, as a result of which this Administration created through Executive Order No. 34 (2006) the Division of Minority and Women Business Development (“Division of M/W Business Development”); and

WHEREAS, Executive Order No. 34 charged the Director of the Division of M/W Business Development with monitoring programs to increase the participation of minority and women-owned businesses in the State’s purchasing and procurement processes; and

WHEREAS, since its inception, the Division of M/W Business Development, working with the Department of the Treasury’s Office of Supplier Diversity (“OSD”), has identified strategies to increase the number of small and minority and women-owned businesses interested in and eligible to benefit from state procurement activity; and

WHEREAS, the Division of M/W Business Development and OSD have increased outreach to and expanded the ability of these businesses to fulfill bid requirements for state contracts; and

WHEREAS, the Division of Public Contracts Equal Employment Opportunity Compliance in the Department of the Treasury (Division of Contract Compliance) monitors the employment of women and minorities with businesses that contract with government in an effort to ensure that contractors and vendors make good faith efforts to hire minorities and women in accordance with targeted goals based on the United States Census’ workforce availability statistics;

NOW, THEREFORE, I, JON S. CORZINE, Governor of the State of New Jersey, by virtue of the authority vested in me by the Constitution and by the Statutes of this State, do hereby ORDER and DIRECT:

1. All members of the public should be afforded the opportunity to benefit from the federal economic recovery funds and associated state spending, and in particular, this Administration re-affirms the State’s commitment, expressed in statute and regulation, that every public contract, whether for construction services, goods, or other services, shall provide equal employment opportunity for women and minorities.

2. The Commissioners of the Departments of Community Affairs, Education, Environmental Protection, and Transportation; the President of the Board of Public Utilities; and the executive directors of the Schools Development Authority and the Economic Development Authority are directed to meet with members of the Governor's office, the Department of the Treasury, and representatives of the United States Department of Labor's Office of Federal Contract Compliance Programs (OFCCP) to ensure that those departments receiving the bulk of federal economic recovery funds will provide the OFCCP their complete cooperation in complying with its mandates.

3. The Division of Contract Compliance shall be the entity within the Executive Branch responsible for determining whether minorities and women have been offered a fair opportunity for employment on State contracts. Executive branch departments and agencies, independent authorities, and State colleges and universities are directed to cooperate fully with the Division of Contract Compliance's enforcement efforts, consistent with law, and to award public contracts only to those businesses that agree to comply with equal employment opportunity and affirmative action requirements.

4. The Division of Contract Compliance shall work cooperatively with the OFCCP, including sharing its workforce data to the maximum extent permitted by law, to assist the OFCCP in its enforcement efforts.

5. When not restricted by any other State or federal law, the Division of Contract Compliance shall determine whether each of the State entities whose performance it monitors (the "Reporting Agencies" listed in Appendix A to this Order) properly allocated and released to the Department of Labor and Workforce Development, as authorized by law, one-half of one percent of the total cost of a construction contract of \$1,000,000 or more, to be used by the department for the New Jersey Builders Utilization Initiative for Labor Diversity program to train minorities and women for employment in construction trades. This provision shall apply to those construction contracts where the funding for the contract consists entirely of appropriated funds or a combination of funds from appropriated funds and other sources.

6. As a result of the aforementioned significant disparities in employment of minorities and women on construction sites and within the construction trades, all construction contracts entered into and funded, in whole or in part, by the State shall include mandatory EEO/AA contract language (in the form of Appendix B to this Order) that requires contractors to make a good faith effort to recruit and employ minorities and women as required by provisions of the Administrative Code, including but not limited to N.J.A.C. 17:27-3.6 to 3.8, and 17:27-7.3 and 7.4. In addition to the language set forth in Appendix B, such construction contracts shall contain the contractual language as required by N.J.A.C. 17-27-3.6, 3.7, and 3.8. As to the portion of each contract that is State funded, the language of the contract shall provide, consistent with Appendix B, that payment may be withheld for failure of the contractor to demonstrate to the satisfaction of the Reporting Agency that the required good faith effort was made. Failure of a contractor to satisfy the good faith effort requirement of its contract may also subject it to assessments imposed pursuant to findings of the Division of Contract Compliance in the Department of the Treasury, in accordance with N.J.A.C. 17:27-10.

7. Except as described in subparagraphs (a) and (b) of this paragraph, each Executive Branch agency that is a recipient of federal economic recovery funds pursuant to ARRA shall include in any contract, grant, or agreement funded in whole or in part with ARRA funds a clause requiring subrecipients, contractors, subcontractors, local education agencies, and vendors to post all job openings created pursuant to the contract, grant, or agreement on the State's Job Bank at least 14 days before hiring is to commence. The clause shall state: "Since the funds supporting this contract, grant, or agreement are provided through the American Recovery and Reinvestment Act of 2009 (ARRA), the subrecipient, contractor, subcontractor, local education agency, or vendor will post any jobs that it creates or seeks to fill as a result of this

contract, grant, or agreement. The subrecipient, contractor, subcontractor, local education agency, or vendor will post jobs to the New Jersey State Job Bank by submitting a job order using the form available at <http://www.NJ.gov/JobCentralNJ>, notwithstanding any other posting the subrecipient, contractor, subcontractor, local education agency, or vendor might make. Any advertisements posted by the subrecipient, contractor, subcontractor, local education agency, or vendor for positions pursuant to this contract, grant, or agreement must indicate that the position is funded with ARRA funds."

a. Posting shall not be required where the employer intends to fill the job opening with a present employee, a laid-off former employee, or a job candidate from a previous recruitment, where pre-existing, legally binding collective bargaining agreements provide otherwise, or where an exception has been granted to the Reporting Agency by the Department of Labor and Workforce Development.

b. Nothing in this Order shall be interpreted to require the employment of apprentices if such employment may result in the displacement of journey workers employed by any employer, contractor, or subcontractor.

8. All local government entities and local education agencies that have received or will receive directly from a federal agency federal economic recovery funds are strongly encouraged to require their contractors and subcontractors to post job openings on the State's Job Bank at least 14 days before hiring is to commence. Moreover, all New Jersey employers that enter into contracts funded with ARRA funds received by a local government entity or a local education agency directly from a federal agency are likewise strongly encouraged to post job openings created pursuant to the ARRA.

9. The Division of M/W Business Development shall send to the Reporting Agencies the contractual language set forth in Appendix C of this Order. Provisions of this contractual language have been shown to have a significant impact on (a) increasing the number of small and minority and women-owned businesses aware of contracting opportunities with the State and (b) increasing the number of such businesses competing for contracts with the State or subcontracts with entities contracting with the State. The Division of M/W Business Development shall work with each Reporting Agency to ensure the reporting of and ensure compliance with contract-specific contracting and subcontracting goals for the Reporting Agency that are consistent with the availability percentages set forth in Appendix D. These goals should incorporate good faith effort requirements and should be adjusted annually, consistent with the availability of minority and women-owned businesses for which significant disparities in utilization have been demonstrated in each business category.

10. Each Reporting Agency shall:

a. Inform the Division of M/W Business Development of contracting opportunities at the same time that it advertises or otherwise posts public notices of such opportunities, via consistent and timely upload of all-inclusive information to the bid opportunities database services managed by the Division of M/W Business Development. All pre-bid requirements shall be prominently advertised at the time of uploading to the Division of M/W Business Development databases;

b. Actively and regularly use the databases and other on-line services managed and operated by the Division of M/W Business Development to identify additional potential bidders. Because these databases and on-line services identify minority and women-owned businesses known to and registered or certified with the Division of M/W Business Development, the ongoing use of these resources by buyers, procurement agents, and other purchasing staff shall be closely monitored by the Reporting Agency's senior management;

c. Contact the businesses identified in the Division of M/W Business Development's databases and on-line services to provide them with notice of the contracting opportunities available through the Reporting Agency; and

d. Report to the Division of M/W Business Development all payments and awards prime contractors have issued to subcontractors, identifying payments and awards to minority and women-owned businesses on at least a quarterly basis.

11. To the maximum extent practicable, and when not restricted by any other State or federal law, each Reporting Agency shall incorporate the substance of the contractual language set forth in Appendix C into its contracts, while continuing to follow the particular State and federal laws and regulations governing its contracting and procurement practices.

12. Each Reporting Agency shall, where substitution of subcontractors or sub-consultants is permitted, promulgate policies governing the circumstances under which contractors or consultants may substitute subcontractors or sub-consultants named in bid proposals or otherwise identified as small or women or minority-owned business subcontractors, sub-consultants, or vendors ("Substitution Policies"). The Substitution Policies shall provide that:

a. The contractor or consultant must notify and obtain approval from a small or women or minority-owned business subcontractor, sub-consultant, or vendor ("SMWBE contractor") before including that contractor in a bid proposal or similar contract-related submission;

b. The contractor or consultant must notify and obtain authorization from the Reporting Agency before it substitutes a SMWBE contractor named in a bid proposal or other contract-related submission; and

c. If the substitution is approved, the contractor or consultant shall make a good faith effort to utilize another SMWBE contractor in place of the previous SMWBE contractor.

13. Each Reporting Agency shall report to the Division of M/W Business Development when it has incorporated the language set forth in Appendix C in its contracts. It shall also report to the Division of M/W Business Development when it has adopted its Substitution Policy, where such policy is permitted. The Division of M/W Business Development shall report on the number of Reporting Agencies that have modified their contracts and adopted a Substitution Policy at three month intervals until all of the Reporting Agencies have completed incorporation of the contractual language set forth in Appendix C and, where legally permitted, adoption of the Substitution Policy.

14. Nothing in this Order shall modify existing law, state or federal, or authorize a Reporting Agency to amend, modify, or otherwise alter pre-existing legal obligations. Further, this Order shall be interpreted consistently with the ARRA, and the federal regulations and guidelines governing its implementation, and in the event of a conflict between this Order and federal law governing ARRA, the Order shall be interpreted to comply with federal law.

15. Within 90 days of the date of this Order, the Division of M/W Business Development shall prepare a Contracting Guide identifying the management practices that have the greatest success in: (a) increasing the number of small and minority and women-owned businesses made aware of contracting opportunities with the State; and (b) increasing the number of such businesses competing for contracts with the state or subcontracts with entities contracting with the state. As soon as practicable thereafter, the Division of M/W Business Development shall distribute the Contracting Guide to the Reporting Agencies.

16. As soon as practicable after its receipt of the Contracting Guide, each Reporting Agency shall implement those provisions that it views as most likely to have the greatest impact in increasing contracting opportunities for small and minority and women-owned businesses.

17. Within one year and ninety days of the effective date of this Order, the Division of M/W Business Development and the Division of Contract Compliance shall each prepare a report describing the Reporting Agencies' implementation of this Order. The Division of M/W Business Development and the Division of Contract Compliance each shall prepare a second report within one year of issuing its first report.

18. The Department of Labor and Workforce Development shall work together with all other Reporting Agencies that will receive ARRA funding and with the representatives of the United States Environmental Protection Agency, the Federal Departments of Labor, Energy, Transportation, and Housing and Urban Development, and any other federal agencies distributing ARRA funds to:

- a. Coordinate with labor unions that will aggressively recruit minorities and women for apprenticeships and training opportunities;
- b. Increase outreach to and enrollment of minorities and women in apprenticeship, training, and related programs; and
- c. Ensure that, to the greatest extent possible under the law, minorities and women apprentices and trainees are working on State and ARRA-funded work sites.

19. The Department of the Treasury and other departments, agencies, and independent authorities shall, consistent with law, take steps to increase their engagement of small, minority, or women-owned or controlled banks and credit unions to meet their financial service's needs.

20. This Order shall take effect immediately.

GIVEN, under my hand and seal thi^s 28th day of August Two Thousand and Nine, and of the Independence of the United States, the Two Hundred and Thirty-Fourth.

/s/ Jon S. Corzine

Governor

[seal]

Attest:

/s/ Kay Walcott-Henderson

First Assistant Chief Counsel

APPENDIX A**LIST OF REPORTING AGENCIES**

Board of Public Utility Commissioners
Casino Control Commission
Casino Reinvestment Development Authority
Commission on Higher Education
Commission on Science & Technology
Council on Affordable Housing
Department of Agriculture
Department of Military & Veterans' Affairs
Department of Banking & Insurance
Department of Children & Families
Department of Community Affairs
Department of Corrections
Department of Education
Department of Environmental Protection
Department of Health and Senior Services
Department of Human Services
Department of Labor and Workforce Development
Department of Law & Public Safety
Department of Public Advocate
Department of State
Department of Transportation
Department of the Treasury
Division of Property Management and Construction
Election Law Enforcement Commission
Fort Monmouth Economic Revitalization Planning Authority
Garden State Preservation Trust
Higher Education Student Assistance Authority
Kean University
Legalized Games of Chance Control Commission
Montclair State University
Motion Picture Commission
Motor Vehicle Commission
New Jersey City University
New Jersey Cultural Trust
New Jersey Institute of Technology
New Jersey Transit
NJ Building Authority
NJ Economic Development Authority
NJ Educational Facilities Authority
NJ Environmental Infrastructure Trust
NJ Health Care Facilities Financing Authority
NJ Highlands Council
NJ Housing & Mortgage Finance Agency
NJ Maritime Pilot and Docking Pilot Commission
NJ Meadowlands Commission
NJ Pinelands Commission

NJ Public Television & Radio (NJN) NJ Racing Commission NJ Redevelopment Authority
NJ Schools Development Authority
NJ Sports & Exposition Authority
NJ State Museum
NJ Turnpike Authority
NJ Water Supply Authority
North Jersey Transportation Planning Authority
North Jersey District Water Supply Commission
Office of Homeland Security
Office of Information Technology
Office of the Child Advocate
Office of the Inspector General
Office of the Public Defender
Ramapo College
Rowan University
Rutgers University
South Jersey Port Corporation
South Jersey Transportation Authority
South Jersey Transportation Planning Organization
State Agriculture Development Committee
State Economic Recovery Board For Camden
State Ethics Commission
State Employment & Training Commission
State Lottery Commission
Stockton College
The College of New Jersey
Thomas Edison State College
Transportation Trust Fund Authority
University of Medicine & Dentistry of New Jersey
William Paterson University

APPENDIX B

It is the policy of the South Jersey Port Corporation that its contracts should create a workforce that reflects the diversity of the State of New Jersey. Therefore, contractors engaged by the South Jersey Port Corporation to perform under a construction contract shall put forth a good faith effort to engage in recruitment and employment practices that further the goal of fostering equal opportunities to minorities and women.

The contractor must demonstrate to the South Jersey Port Corporation's satisfaction that a good faith effort was made to ensure that minorities and women have been afforded equal opportunity to gain employment under the South Jersey Port Corporation's contract with the contractor. Payment may be withheld from a contractor's contract for failure to comply with these provisions.

Evidence of a "good faith effort" includes, but is not limited to:

1. The Contractor shall recruit prospective employees through the State Job bank website, managed by the Department of Labor and Workforce Development, available online at <http://NJ.gov/JobCentralNJ>.
2. The Contractor shall keep specific records of its efforts, including records of all individuals interviewed and hired, including the specific numbers of minorities and women.
3. The Contractor shall actively solicit and shall provide the South Jersey Port Corporation with proof of solicitations for employment, including but not limited to advertisements in general circulation media, professional service publications and electronic media.
4. The Contractor shall provide evidence of efforts described at 2 above to the South Jersey Port Corporation no less frequently than once every 12 months.
5. The Contractor shall comply with the requirements set forth at N.J.A.C. 17:27.

APPENDIX C

It is the policy of the South Jersey Port Corporation that small businesses (each a “small business enterprise” or “SBE”), as determined and defined by the State of New Jersey, Division of Minority and Women Business Development (“Division”) and the New Jersey Department of the Treasury (“Treasury”) in N.J.A.C. 17:14 et seq. or other application regulation, should have the opportunity to participate in South Jersey Port Corporation Contracts.

To the extent the Firm engages subcontractors or sub-consultants to perform Services for the South Jersey Port Corporation pursuant to this Contract, the Firm must demonstrate to the South Jersey Port Corporation’s satisfaction that a good faith effort was made to utilize subcontractors and sub-consultants who are registered with the Division as SBEs. Furthermore, the South Jersey Port Corporation shall be evaluated quarterly by the Division, based on its attainment of the Participation Goals set forth in the State of New Jersey Construction Services Disparity Study (October 2005) and the State of New Jersey Disparity Study of Procurement in Professional Services, Other Services, and Goods and Commodities (June, 2005). (These participation goals are set forth below.)

Evidence of a “good faith effort” includes, but is not limited to:

1. The Firm shall request listings of SBEs from the Division (609) 292-2146 and/or the South Jersey Port Corporation and attempt to contact same.
2. The Firm shall keep specific records of its efforts, including records of all requests made to the Division, the names of SBEs contacted, and the means and results of such contacts, including without limitation receipts from certified mail and telephone records.
3. The Firm shall actively solicit and shall provide the South Jersey Port Corporation with proof of solicitations of SBEs for the provision of Services, including advertisements in general circulation media, professional service publications and small business, minority-owned business or women-owned business focus media.
4. The Firm shall provide evidence of efforts made to identify categories of Services capable of being performed by SBEs.
5. The Firm shall provide all potential subcontractors and sub-consultants that the Firm has contacted pursuant to 2 or 3 above with detailed information regarding the scope of work of the subject contract.
6. The Firm shall provide evidence of efforts made to use the goods and/or services of available community organizations, consultant groups, and local, State, and federal agencies that provide assistance in the recruitment and placement of SBEs.

Furthermore, the Firm shall submit proof of its subcontractors’ and/or sub-consultants’ SBE registrations on the form attached as Exhibit __, and shall complete such other forms as may be required by the South Jersey Port Corporation for State reporting as to participation.

Participation Goals

1. Construction Services Contracts/Subcontracts (including new construction and renovations, except routine building maintenance; residential and non-residential building construction; heavy construction, such as streets, roads and bridges; and special trade construction, such as fencing, HVAC, paving and electrical).

(a) State Agencies/Authorities/Commissions

African Americans -- 6.3%
 Asian Americans -- 4.34%

(b) State Colleges and Universities

African Americans -- 6.3%
 Asian Americans -- 4.34%
 Caucasian Females -- 12.67%

2. Construction-Related Services Contracts/Subcontracts (including design services, such as architectural, engineering and construction management services, that are performed as part of a construction project).

State Colleges and Universities

African Americans -- 4.51%
 Asian Americans -- 7.11%
 Hispanics -- 4.

3. Professional Services (with the exception of those professional services deemed to be construction-related, all services that are of a professional nature and requiring special licensing, education degrees and/or very highly specialized expertise, including accounting and financial services, advertising services, laboratory testing services; legal services; management consulting services; technical services and training).

State Agencies/Authorities/Commissions/Colleges and Universities

African Americans -- 2.47%
 Asian Americans -- 1.47%
 Hispanics -- 1.1%
 Native Americans -- 0.07%
 Caucasian Females -- 3.

4. Other Services (any service that is labor-intensive and neither professional nor construction-related, including, but not limited to equipment rental; janitorial and maintenance services; landfill services; laundry and dry cleaning; maintenance and repairs; printing; real property services; security services; special department supplies; subsidy, care and support; telecommunications; and temporary help).

State Agencies/Authorities/Commissions/Colleges and Universities

African Americans -- 1.22%
 Asian Americans -- 0.85%
 Hispanics -- 0.67%
 Native Americans -- 0.05%
 Caucasian Females -- 1.

5. Goods and Commodities (equipment and consumable items purchased in bulk, or a deliverable product including, but not limited to automobiles and equipment; chemicals and laboratory supplies, construction

materials and supplies; equipment parts and supplies; fuels and lubricants; janitorial and cleaning supplies; office equipment; office supplies; radio equipment; special department supplies; technical supplies; tires and tubes; traffic signals; and uniforms).

State Agencies/Authorities/Commissions/Colleges and Universities

African Americans -- 2.71%

Asian Americans -- 1.74%

Hispanics -- 1.32%

Native Americans -- 0.10%

Caucasian Females -- 4.45%

Appendix D

Consistent with the findings of the State of New Jersey Construction Services Disparity Study (October 2005) and the State of New Jersey Disparity Study of Procurement in Professional Services, Other Services, and Goods and Commodities (June 13, 2005), each Reporting Agency should aspire to allocate a portion of its total contracting dollars in accordance with the following goals.

1. Construction Services Contracts/Subcontracts (including new construction and renovations, except routine building maintenance; residential and non-residential building construction; heavy construction, such as streets, roads and bridges; and special trade construction, such as fencing, HVAC, paving and electrical.

(c) State Agencies/Authorities/Commissions

African Americans -- 6.3%
Asian Americans -- 4.34%

(d) State Colleges and Universities

African Americans -- 6.3%
Asian Americans -- 4.34%
Caucasian Females -- 12.67%

2. Construction-Related Services Contracts/Subcontracts (including design services, such as architectural, engineering and construction management services, that are performed as part of a construction project).

State Colleges and Universities

African Americans -- 4.51%
Asian Americans -- 7.11%
Hispanics -- 4.

3. Professional Services (with the exception of those professional services deemed to be construction-related, all services that are of a professional nature and requiring special licensing, education degrees and/or very highly specialized expertise, including accounting and financial services, advertising services, laboratory testing services; legal services; management consulting services; technical services and training).

State Agencies/Authorities/Commissions/Colleges and Universities

African Americans -- 2.47%
Asian Americans -- 1.47%
Hispanics -- 1.1%
Native Americans -- 0.07%
Caucasian Females -- 3.

4. Other Services (any service that is labor-intensive and neither professional nor construction-related, including, but not limited to equipment rental; janitorial and maintenance services; landfill services; laundry and dry cleaning; maintenance and repairs; printing; real property services; security services; special department supplies; subsidy, care and support; telecommunications; and temporary help).

State Agencies/Authorities/Commissions/Colleges and Universities

African Americans -- 1.22%
Asian Americans -- 0.85%
Hispanics -- 0.67%
Native Americans -- 0.05%
Caucasian Females -- 1.

4. Goods and Commodities (equipment and consumable items purchased in bulk, or a deliverable product including, but not limited to automobiles and equipment; chemicals and laboratory supplies, construction materials and supplies; equipment parts and supplies; fuels and lubricants; janitorial and cleaning supplies; office equipment; office supplies; radio equipment; special department supplies; technical supplies; tires and tubes; traffic signals; and uniforms).

State Agencies/Authorities/Commissions/Colleges and Universities

African Americans -- 2.71%
Asian Americans -- 1.74%
Hispanics -- 1.32%
Native Americans -- 0.10%
Caucasian Females -- 4.45%

GIVEN, under my hand and seal thi^s 28th day of August
Two Thousand and Nine, and of the Independence of
the United States, the Two Hundred and Thirty-Fourth.

/s/ Jon S. Corzine

Governor

[seal]

Attest:

/s/ Kay Walcott-Henderson

First Assistant Chief Counsel



**STATE OF NEW JERSEY
DEPARTMENT OF THE TREASURY
DIVISION OF PURCHASE AND PROPERTY**

Q16

**33 WEST STATE STREET, P.O. BOX 230
TRENTON, NEW JERSEY 08625-0230**

OWNERSHIP DISCLOSURE FORM

BID SOLICITATION #: _____ **VENDOR {BIDDER}:** _____

**ALL PARTIES ENTERING INTO A CONTRACT WITH THE STATE ARE REQUIRED TO PROVIDE THE
INFORMATION REQUESTED PURSUANT TO N.J.S.A. 52:25-24.2.**

PLEASE NOTE THAT IF THE VENDOR/BIDDER IS A NON-PROFIT ENTITY, THIS FORM IS NOT REQUIRED.

PART 1

Are there any individuals, partners, members, stockholders, corporations, partnerships, or limited liability companies owning a 10% or greater interest in the Vendor {Bidder}? YES NO

If you answered, "YES" above, you must disclose the following: (a) the names and addresses of all stockholders in the corporation who own 10 percent or more of its stock, of any class; (b) all individual partners in the partnership who own a 10 percent or greater interest therein; or, (c) all members in the limited liability company who own a 10 percent or greater interest therein.

NAME	_____
ADDRESS 1	_____
ADDRESS 2	_____
CITY	_____ STATE _____ ZIP _____

NAME	_____
ADDRESS 1	_____
ADDRESS 2	_____
CITY	_____ STATE _____ ZIP _____

NAME	_____
ADDRESS 1	_____
ADDRESS 2	_____
CITY	_____ STATE _____ ZIP _____

NAME	_____
ADDRESS 1	_____
ADDRESS 2	_____
CITY	_____ STATE _____ ZIP _____

NAME	_____
ADDRESS 1	_____
ADDRESS 2	_____
CITY	_____ STATE _____ ZIP _____

Attach Additional Sheets If Necessary.

PART 2

YES **NO**

Of those entities disclosed above owning a 10% or greater interest in the Vendor {Bidder}, are there any individuals, partners, members, stockholders, corporations, partnerships, or limited liability companies owning a 10% or greater interest of those listed entities?

If you answered, "YES" above, you must disclose the following: (a) the names and addresses of all stockholders in the corporation who own 10 percent or more of its stock, of any class; (b) all individual partners in the partnership who own a 10 percent or greater interest therein; or, (c) all members in the limited liability company who own a 10 percent or greater interest therein. Please note that this disclosure shall be continued until names and addresses of every non-corporate stockholder, and individual partner, and member, exceeding the 10 percent ownership criteria established in this act, has been identified.

Name of the entity listed above to which the disclosure below applies: _____

NAME	_____
ADDRESS 1	_____
ADDRESS 2	_____
CITY	_____ STATE _____ ZIP _____

NAME	_____
ADDRESS 1	_____
ADDRESS 2	_____
CITY	_____ STATE _____ ZIP _____

NAME	_____
ADDRESS 1	_____
ADDRESS 2	_____
CITY	_____ STATE _____ ZIP _____

NAME	_____
ADDRESS 1	_____
ADDRESS 2	_____
CITY	_____ STATE _____ ZIP _____

NAME	_____
ADDRESS 1	_____
ADDRESS 2	_____
CITY	_____ STATE _____ ZIP _____

Attach Additional Sheets If Necessary.

PART 3

As an alternative to completing this form, a Vendor {Bidder} with any direct or indirect parent entity which is publicly traded may submit the name and address of each publicly traded entity and the name and address of each person that holds a 10 percent or greater beneficial interest in the publicly traded entity as of the last annual filing with the federal Securities and Exchange Commission or the foreign equivalent, and, if there is any person that holds a 10 percent or greater beneficial interest, also shall submit links to the websites containing the last annual filings with the federal Securities and Exchange Commission or the foreign equivalent and the relevant page numbers of the filings that contain the information on each person that holds a 10 percent or greater beneficial interest.

PREVAILING WAGE ACT COMPLIANCE DECLARATION

The Contractor hereby agrees to comply in all respects with the New Jersey Prevailing Wage Act, Chapter 150, P.L. 1963 as amended. A copy of the prevailing wage rates pertaining to the work issued by the New Jersey Department of Labor and Industry entitled, "Prevailing Wage Rate Determination", is attached at the close of this section, or is available upon request at the Offices of the South Jersey Port Corporation. Pursuant to N.J.S.A., 34:11-56.37 and 34:11-56.38, Prevailing Wage Act, no public works contract may awarded to any contractor or subcontractor or to any firm, corporation or partnership in which they have an interest on the disbarred bidders list located at the end of this specification, or available upon request at the Offices of the South Jersey Port Corporation, until expiration date give. Workmen shall be paid not less than such prevailing wage rate. In the event it is found that any workmen employed by the Contractor or any Subcontractor covered by the contract herein has been paid a rate of wages less then the prevailing rate required to be paid such contract, the Owner may terminate the Contractor's or Subcontract's right to proceed with the work or such part of the work as to which there has been a failure to pay required wages and to prosecute the work to completion or otherwise. The Contractor and his sureties shall be liable to the Owner for any excess cost occasioned thereby.

Before final payment is made by or on behalf of the Owner any sum or sums due to the work, the Contract of Subcontractor shall file with the treasurer of the Owner, written statements in a form satisfactory to the Commissioner of Labor and Industry certifying to the amounts then due owing from such contractor or subcontractor filling such statement to any and all workmen wages due on account of the work, setting forth therein the name of the persons whose wages are unpaid and the amount due to each respectively which statement shall be certified by the oath of the Contractor or Subcontractor as the case may be in accordance with the said New Jersey Prevailing Wage Act.

The prevailing wage rate shall be determined by the Commissioner of Labor and Industry or his duly authorized deputy or representative.

The undersigned in an (individual)(partnership)(corporation) under the Laws of the State of, _____ having principal offices at _____.

Signature: _____

Print Name: _____

Company Name : _____

Address : _____

Phone Number: _____

COMPLIANCE WITH PUBLIC WORKS CONTRACTOR REGISTRATION ACT

The bidder shall comply with the Public Works Contractor Registration Act P.L. 1999, c 238 (N.J.S.A, 34:11-56.48, et seq.) on all bids for public works as defined in the law. Proof of compliance with this law when it applies, must be submitted with the bid.

- Attached hereto is a copy of Certificate of Registration pursuant to N.J.S.A. 34:11-56.54

Or

- Attached hereto is a copy of filed registration from and proof of payment of the registration fee pursuant to N.J.S.A. 34:11-56.55

Bidders Signature: _____

Bidders Name: _____

Address of Bidder: _____

Signature of Affiant: _____

Printed Name & Title of Affiant: _____

NOTARIZATION SECTION

Subscribed and sworn before me this _____ day of _____, 20____.

Notary Public of _____

My Commission Expires: _____

BUY AMERICAN NOTICE

In the performance of the work under this contract the contractor and all subcontractors shall use only domestic materials. Builders may bid using non-domestic material but shall specify wherever such non-domestic materials are bid the difference in cost between the domestic and non-domestic materials and shall explain any justification for the use of non-domestic materials such as but not limited to unavailability, inferiority, incompatibility, impracticality, increased cost of domestic materials, etc.

Buy America Notice

Q19

All Federally Funded Construction Projects

Reference:

The FHWA Buy America statutory provisions are in 23U.S.C.313 and the regulatory provisions are in 23CFR635.410.

Buy America

Q&A's: http://www.fhwa.dot.gov/construction/contracts/buyam_qa.cfm

Applicability:

Applicable to all Federal-aid projects.

Guidance:

Simply stated, the FHWA's Buy America policies require a DOMESTIC manufacturing process for ALL steel or iron products that are permanently incorporated in a Federal-aid highway construction project. Manufacturing begins with the initial melting and mixing, and continues through the coating stage. Any process which modifies the chemical makeup, physical shape or finish is considered a manufacturing process and as such must be performed in the United States. Waivers may be granted, in rare cases that meet specified criteria. Refer to the Q&A's above for more details.

Buy America requirements apply to the entire federal aid project even if some steel or iron products are purchased with non federal funds. All steel/iron must be manufactured in the United States.

Buy America provisions do allow use of a small portion of foreign steel and iron materials (less than one tenth of one percent of the total contract cost [0.1%] or \$2500, whichever is greater). Be vigilant and document. The consequences of exceeding this amount can be severe. Maintain a separate file for "Buy America" to facilitate oversight, certifications and compliance. It's that important.

Buy America requirements apply to all UTILITY RELOCATION WORK (regardless of funding) that is part of a FHWA funded contract and to all federally funded standalone utility work. Standalone, non-FHWA funded, contracts are NOT covered.

Compliance:

The RE needs to receive the Buy America certification at time of delivery--absolutely PRIOR TO incorporating the steel/iron product in the project. Typically, the certification states:

"All manufacturing processes for these steel and iron materials, including the application of coatings, have occurred in the United States."

The certification MUST BE current, dated, signed and be specific to the material and project at hand. Step certification is encouraged when manufacturing occurs at different locations. This involves separate, self-supporting, certifications that are prepared at each location and accompany the product to the job site—a documentation trail confirming ALL manufacturing in the US.

Contract Changes and Time ^{Q19}

Inherent in every project – processing is key

Reference:

Title 23 C.F.R. 635.120 - Changes and extra work
Title 23 C.F.R. 635.121 - Contract time and contract time extensions
2007 NJDOT Standard Specifications for Road and Bridge Construction

Guidance:

Contract changes and progress of work must be monitored and documented daily.

The State's standard specifications shall govern the approval of changes in a contract. Below are some provisions that apply:

- Do not deviate from the requirements of the contract unless and until a field order is issued.
- Reimbursement cannot be made until a change order is approved by the Department.
- Extensions in contract time will only be granted for excusable, compensable delays and only for work defined on the critical path of the project, as defined in an approved project schedule.

Issue a formal "Notice to Proceed" (NTP) and stipulate a Contract Completion Date.

Example NTP: *The NTP date for this project is Friday, June 15, 2012. The duration for this project per section 100.03 of the Supplemental Specifications is sixty (60) calendar days. The date for final completion is Tuesday, August 14, 2012.*

Basic Requirements:

"Time is of the essence as to all time frames stated in the Contract", Section 108.10 NJDOT Standard Specification

Any new or extra work needs to be defined and approved prior to being included in the contract. This approval is done through a change order which requires written justification, a breakdown of costs and quantities, and timely approvals.

Contract line item overruns are not permissible without formal requests and approvals.

Time shall always be evaluated as part of a change order.

Change orders for a time extension only must be fully substantiated in accordance with the contract requirements and specifications. Weather, right-of-way, utilities, and/or rail road work are not normally a legitimate basis for excusable, compensable delays.

Liquidated Damages: If changes in time are not fully justified and documented, liquidated damages may be assessed per the contract documents. Daily documentation of work activities is crucial.

The standard form DC-173A will be used to document the change order.

New or Supplemental Costs:

All new or supplemental costs **must be** negotiated, itemized and justified. All documentation of the negotiations, including the basis of cost, must be on file and included in the change order request.

DBE/ESBE/SBE Program

Project Responsibility from Day One

References:

- FHWA regulatory provisions: 49 CFR 26
- NJDOT's Construction Procedure Handbook for ESBE/DBE & SBE Program Implementation: Section V, Subsection B
- NJDOT DBE & ESBE Programs: <http://www.state.nj.us/transportation/business/civilrights/dbe.shtm>

Applicability:

All federal aid projects with a contract DBE/ESBE requirement.

Guidance:

The DBE Program is a legislatively mandated USDOT program. The mission of NJDOT's Disadvantaged and Small Business Programs is to promote contracting opportunities for small, socially and economically disadvantaged firms who seek to do business with the NJDOT.

DBE contract specifications are legally binding and **must be enforced in the same fashion as any other contract requirement**. Failure to carry out contract provisions may result in loss of Federal funds. The success of these programs is achieved by thoroughly implementing the monitoring and reporting procedures in place AS THE PROJECT PROGRESSES. REs will then be able address any issues early and take effective steps to ensure proper administration of the DBE/ ESBE/SBE Program and avoid any penalties.

Implementation:

Beginning at the commencement of the project, the RE must continuously monitor DBE/ESBE/SBE participation as the project progresses to ensure that that the assigned DBE /ESBE/SBE goal on the contract will be met by the time the project is completed. This is a project responsibility. Maintain a separate file.

1. Check Recommendation To Award memorandum and the Schedule of Participation ESBE/DBE/SBE Form CR-266 (former "Form A") to determine status of subcontractors to monitor for compliance.
2. During the course of the Contract, the RE will monitor true participation by comparing contractor DBE/ ESBE/SBE Goal commitments against each Request for Approval to Sublet Form DC-18. In addition, the RE will cross check the Daily Work Reports with each affected Form DC-18, the Recommendation To Award, and the Utilization of ESBE/DBE/SBE Monthly Report Form CR-267.
3. During construction the RE and staff will use the Daily Work Report to document on-site monitoring of stipulated DBE work items and contractor performing the work in order to insure compliance.
4. The RE will notify the Person in Responsible Charge and the Contractor in writing of any violations and will direct the Contractor to comply with these requirements. Revisions can only be made to the committed DBE/ ESBE/SBE Program when the Contractor submits a revised Form CR-266.
5. Failure of the Contractor to comply will result in the RE notifying the Person in Responsible charge, NJDOT District Office, and DCR/AA by memorandum and presenting pertinent documents for their review and action. The RE must follow-up with all promptly to insure timely resolution.
6. If the DBE/ ESBE/SBE commitment is not fulfilled, documentation supporting adequate good faith effort (GFE) must be promptly submitted by the Contractor with Form CR-268. GFE will be reviewed by DCR/AA based on the guidance set forth in 49 CFR Part 26 Appendix A. .

Pedestrian Facilities and ADA compliance – Curb Ramps

Must Conform To Standards and Contract Plans

References:

All pedestrian facilities constructed or reconstructed must provide safe and easy accessibility **for all users**.

The Americans with Disabilities Act (ADA) of 1990
 Section 504 of the Rehabilitation Act of 1973
 28 CFR Part 35.151(e)
 NJDOT Construction Details 607 and 608

Guidance:

Inspectors need to have immediate on-site access to contract plans.

It is the inspector's responsibility to insure that all sidewalks and ramps are constructed in strict accordance with contract plans. Slope is of critical importance; as are location, alignment, length, width and depth. Check plans. Measure-measure-measure, compare with plans and **DOCUMENT** conformance and quantities.

Immediately elevate questions or 'issues' for discussion and resolution. Document!

It starts with the concrete forms - PRIOR TO the placement of concrete.

NJDOT Standard Specifications, Sections 606 and 607, require RE approval of excavation and forms prior to placing concrete. Nonconformance at this stage means nonconformance with final product.

All measurements, checks, approvals and findings, including pay quantities, must be clearly documented. They become "Source Documents" – a critical item necessary to support payment.

This simple and basic guidance will promote compliance and avoid completed work that does not conform to contract plans and specifications.

Be Vigilant:

The plans should be consistent with established design standards. If you note any design problems or inconsistencies, document and bring them to the attention of the RE/person in charge. Field inspection and documentation must occur for the following:

- The curb ramp type and crossing location are consistent with the plans.
- The curb ramp running slope **does not exceed 8.3%**.
- The curb ramp cross slope and connecting sidewalks **do not exceed 2.0%**.
- The turning areas (landings) are a minimum of 4 foot by 4 foot and cross slopes do not exceed 2% in both directions.
- All street connections, joints, and grade changes must be flush...no lip.
- There are no protrusions or obstacles within the pedestrian accessible route.
- The surface is firm, stable, & nonslip, including during temporary conditions.
- The pedestrian accessible route is free of utilities unless the design allows for exceptions.
- Detectable warning surface with truncated domes have been properly installed, are color contrasting, and aligned in the direction of pedestrian travel.
- No water ponding at the curb ramp or in the pedestrian pathway.
- Accessibility (walkway) has been provided to pedestrian push buttons, including a turning space at the button location.
- Diagonal ramps are discouraged. If provided for in the plans, they must provide a turning space at the back of curb to facilitate travel to the adjacent pedestrian pathway.

Responsible Charge

Every federal-aid project must have a person in responsible charge.

Reference:

23 CFR 635.105 – ‘*Supervising Agency*’: the State Transportation Department (STD) has responsibility for the construction of all Federal-aid projects, whether or not; it or a local public agency (LPA) performs the work. This section stresses that such projects must receive adequate supervision and inspection to insure that they are completed in conformance with approved plans and specifications.

The regulation provides that the STD and LPA must provide a full time employee to be in "responsible charge" of the project. This cannot be the consultant.

Purpose:

To insure that (think *public interest*) every project receives adequate supervision and inspection to insure that it is completed in conformance with contract plans and specs.

Implementation:

Implementation and accountability is mandated through the person in responsible charge. Who is this person?

STD-For projects administered by the STD, the regulation requires that the person in "responsible charge" be a full-time employed state engineer. This requirement applies even when consultants are providing construction engineering services.

LPA-For locally administered projects, the regulation requires that the person in "responsible charge" be a full time employee of the LPA. The regulation is silent about engineering credentials. Thus, the person in "responsible charge" of LPA administered projects need not be an engineer. This requirement applies even when consultants are providing construction engineering services.

Duties:

Regardless of whether the project is administered by the STD or a LPA, the person designated as being in "responsible charge" is expected to be a full time public employee (not a consultant) who is accountable for the project. This person, may share duties, but is expected to be able to perform the following duties and functions:

- Administers inherently governmental project activities, including those dealing with cost, time, adherence to contract requirements, construction quality and scope of Federal-aid projects;
- Maintains familiarity of day to day project operations, including project safety issues;
- Makes or participates in decisions about changed conditions or scope changes that require change orders or supplemental agreements
- Reviews financial processes, transactions and documentation to ensure that safeguards are in place to minimize fraud, waste, and abuse; and
- Directs project staff, agency or consultant, to carry out project administration and contract oversight, including proper documentation.
- Is aware of the qualifications, assignments and on-the-job performance of the agency and consultant staff at all stages of the project.
- Visits and reviews the project on a frequency that is commensurate with the magnitude and complexity of the project
- On the jobsite for the time needed to verify and insure that the project receives adequate supervision and inspection to insure that work is accomplished in conformance with approved plans and specifications.

Source Documents

An Absolute Must Have

Reference:

23 CFR 635.123: Determination and documentation of PAY QUANTITIES.

Applicability:

Applicable to all Federal-aid projects—basis for payment.

Guidance:

What is a “Source Document”? Look at it in reverse: it’s a document prepared at the source--the ‘source’ being the point of delivery or the location of construction activity.

This is essentially the handwritten “receipt” of exactly how many and what was delivered. It is the **single most important document that substantiates quality and quantities and provides the required basis for payment to the contractor.**

The document consists of notes (documentation) of: counts; measurements (length, width, depth, and slope); calculations of area, volume, weights, etc; sketches; a STATEMENT of compliance with contract plans and specs; field changes; comments; and delivery tickets collected/initialed by the inspector at the point of unloading.

Who develops this documentation? The inspector, who is assigned to that project/location to protect the public interest and to insure that the number, size, and characteristics of what is being delivered match the plans/specs, completes this basic and essential documentation. Incorporate ‘established’ quantities into a **Quantity Summary Sheet** for each work item.

Importance:

Highest level! This source documentation establishes quantities for payment. Without it, the eligibility of pay quantities may come under question. Later, after the fact, verification is very time consuming and often not possible.

Examples:

Item # ___; Sidewalk-Forms: *Checked and measured forms for the sidewalk and ADA ramp at the NE corner of Grand and Market. Specific measurements including depth and slope are shown below (or are shown on the sketches below) along with quantity calculations. Also, noted on plan sheet # 21. Forms were clean, stable and uniform. Base was solid. Expansion joints were in place. All measurements, including depth and slopes, are in conformance with contract plans-a section was added to reach push button. The contractor was given approval to place concrete. (Sect. 606.03.02 DOT Spec)*

*Observed the **placement of concrete** at the NE corner of Grand and Market. Prior approval of forms had been granted. Placement and finishing procedures in accordance with specs. No access water. Curing compound placed 15 minutes after finishing. **Total quantity 24 SY** based on measurements taken. See plan sheet 21 of the contract plans. See calculations.*

Item # ____: **HMA Surface Coarse:** *Inspected HMA placement from Station 3+50 to 9+50. Took numerous measurements of D, W, and Temp as follows. Compaction/finish observed. Equipment and pattern as per spec (describe). Tickets collected at point of unloading. Initialed each w/station. Total tonnage _____. # of tickets _____. Refused one truck (# 254) due to time in transit was substantially over that allowed by spec.*

Item # ____: **Tack Coat;** *Observed test strip and noted several nozzles not functioning. Required repair of distributor to achieve uniform application. Repaired. Checked quantities before and after to affirm actual usage and pay quantity. See notes below.*

IMPORTANT NOTICE

NEW "PAY-TO-PLAY" RESTRICTIONS TO TAKE EFFECT NOVEMBER 15, 2008

Individual Certification of Compliance with Executive Order No. 117 (2008)

I hereby certify as follows:

On or after November 15, 2008, I have not solicited or made any reportable contribution of money or pledge of contribution, including in-kind contributions or company or organization contributions, to the following:

- a) Any candidate committee and/or election fund of the Governor;
- b) A State political party committee;
- c) A legislative leadership committee;
- d) A county political party committee; or
- e) A municipal political party committee

I certify that, to the best of my knowledge and belief, the foregoing statements by me are true. I am aware that if any of the statements are willfully false, I am subject to punishment.

Signed: _____

Print Name: _____ Date: _____

State of New Jersey
Executive Order #117

Governor Jon S. Corzine

WHEREAS, the residents of New Jersey are entitled to a government that is effective, efficient, and free from corruption, favoritism, and waste; and

WHEREAS, in pursuit of those goals, a series of actions have been taken in New Jersey since 2004 – through legislation, executive order, and regulation – to protect the integrity of government contractual decisions and increase the public’s confidence in government by prohibiting the awarding of government contracts to business entities that also are contributors to certain candidates and political parties; and

WHEREAS, among those actions were the issuance of Executive Order No. 134 (2004) and the codification of its provisions into statute in P.L.2005, c.51 (C.19:44A-20.13 et seq.) (“Chapter 51”); and

WHEREAS, since its adoption, Chapter 51 has significantly reduced the influence of contractor contributions in the process of awarding State government contracts and has proven to be an effective method of ensuring that merit and cost-effectiveness drive the government contracting process; and

WHEREAS, this administration is committed to ensuring the highest ethical standards in government contracting and rooting out corruption, favoritism, and waste; and

WHEREAS, experience has shown that additional measures are needed to ensure there is no dilution of the protections provided by Chapter 51 against the improper influence of political contributions on the process of awarding State government contracts and to ensure compliance with the provisions of Chapter 51; and

WHEREAS, many State government contractors, particularly those that provide professional services, are business entities whose form of business organization and ownership structure are such that the political contribution limits in Chapter 51 apply to few if any of the individuals who own or control the entity; and

WHEREAS, the strong public interest in limiting political contributions by businesses that contract with the State requires that the contribution limits in Chapter 51 be applied to such individuals and that those limits otherwise be applied in such a way that the purposes of Chapter 51 will be served regardless of the form of business organization of the State government contractor; and

WHEREAS, because New Jersey’s campaign finance laws permit large, and in some cases unlimited, political contributions to flow between and among various types of political committees and State officeholders, the effectiveness of the restrictions in Chapter 51 can be, and

have been, undermined by the current ability of State government contractors to make large contributions to legislative leadership committees and municipal political party committees; and

WHEREAS, the Constitution of this State requires the Governor to manage the operations of State government effectively and fairly, uphold the law to ensure public order and prosperity, and confront and uproot malfeasance in whatever form it may take; and

WHEREAS, it is the Governor's responsibility to safeguard the integrity of the State government procurement process by ensuring that there is no dilution of the protections provided by Chapter 51 against the improper influence of political contributions on the process of awarding and overseeing the performance of State government contracts and that there be full compliance with the provisions of Chapter 51;

NOW, THEREFORE, I, JON S. CORZINE, Governor of the State of New Jersey, by virtue of the authority vested in me by the Constitution and by the Statutes of this State, do hereby ORDER and DIRECT:

1. For the purposes of this Order:
 - a. "Business entity" means:
 - i. a for-profit entity as follows:
 - A. in the case of a corporation: the corporation, any officer of the corporation, and any person or business entity that owns or controls 10% or more of the stock of the corporation;
 - B. in the case of a general partnership: the partnership and any partner;
 - C. in the case of a limited partnership: the limited partnership and any partner;
 - D. in the case of a professional corporation: the professional corporation and any shareholder or officer;
 - E. in the case of a limited liability company: the limited liability company and any member;
 - F. in the case of a limited liability partnership: the limited liability partnership and any partner;
 - G. in the case of a sole proprietorship: the proprietor; and
 - H. in the case of any other form of entity organized under the laws of this State or any other state or foreign jurisdiction: the entity and any principal, officer, or partner thereof;
 - ii. any subsidiary directly or indirectly controlled by the business entity;

- iii. any political organization organized under section 527 of the Internal Revenue Code that is directly or indirectly controlled by the business entity, other than a candidate committee, election fund, or political party committee; and
 - iv. with respect to an individual who is included within the definition of business entity, that individual's spouse or civil union partner, and any child residing with the individual, provided, however, that, this Order shall not apply to a contribution made by such spouse, civil union partner, or child to a candidate for whom the contributor is entitled to vote or to a political party committee within whose jurisdiction the contributor resides unless such contribution is in violation of section 9 of P.L.2005, c.51 (C.19:44A-20.13 et seq.) ("Chapter 51").
- b. "Contribution" means a contribution reportable by the recipient under "The New Jersey Campaign Contributions and Expenditures Reporting Act," P.L.1973, c.83 (C.19:44A-1 et seq.) made on or after the effective date of this Order.
- 2. Any Executive Branch department, agency, authority, or independent State authority charged with implementing and enforcing Chapter 51 shall apply its provisions to a "business entity" as defined in Paragraph 1(a) of this Order in the same manner as those provisions apply to a "business entity" as defined in section 5 of Chapter 51.
 - 3. Any Executive Branch department, agency, authority, or independent State authority charged with implementing and enforcing Chapter 51 shall apply its provisions to a contribution made to a legislative leadership committee or a municipal political party committee in the same manner as those provisions apply to a contribution to any candidate committee, election fund, or political party committee identified in Chapter 51.
 - 4. Any Executive Branch department, agency, authority, or independent State authority charged with implementing and enforcing Chapter 51 shall apply its provisions to a contribution made to a candidate committee or election fund of any candidate for or holder of the office of Lieutenant Governor in the same manner as those provisions apply pursuant to Chapter 51 to a contribution to any candidate committee or election fund of any candidate for or holder of the office of Governor.
 - 5. This Order shall take effect on November 15, 2008 and is intended to have prospective effect only. This Order shall not apply to any contribution made prior to November 15, 2008.

GIVEN, under my hand and seal this 24th day of September, Two Thousand and Eight, and of the Independence of the United States, the Two Hundred and Thirty-Third.

/s/ Jon S. Corzine

Governor

[seal]

Attest:

/s/ Edward J. McBride, Jr.

Chief Counsel to the Governor

SOUTH JERSEY PORT CORPORATION - DISCLOSURE OF INVESTMENT ACTIVITIES IN IRAN FORM

BID SOLICITATION # AND TITLE: _____

VENDOR NAME: _____

Pursuant to N.J.S.A. 52:32-57, et seq. (P.L. 2012, c.25 and P.L. 2021, c.4) any person or entity that submits a bid or proposal or otherwise proposes to enter into or renew a contract must certify that neither the person nor entity, nor any of its parents, subsidiaries, or affiliates, is identified on the New Jersey Department of the Treasury’s Chapter 25 List as a person or entity engaged in investment activities in Iran. The Chapter 25 list is found on the Division’s website at <https://www.state.nj.us/treasury/purchase/pdf/Chapter25List.pdf>. Vendors/Bidders must review this list prior to completing the below certification. If the SJPC finds a person or entity to be in violation of the law, s/he shall take action as may be appropriate and provided by law, rule or contract, including but not limited to, imposing sanctions, seeking compliance, recovering damages, declaring the party in default and seeking debarment or suspension of the party.

CHECK THE APPROPRIATE BOX

I certify, pursuant to N.J.S.A. 52:32-57, et seq. (P.L. 2012, c.25 and P.L. 2021, c.4), that neither the Vendor/Bidder listed above nor any of its parents, subsidiaries, or affiliates is listed on the New Jersey Department of the Treasury’s Chapter 25 List of entities determined to be engaged in prohibited activities in Iran.

OR

I am unable to certify as above because the Vendor/Bidder and/or one or more of its parents, subsidiaries, or affiliates is listed on the New Jersey Department of the Treasury’s Chapter 25 List. I will provide a detailed, accurate and precise description of the activities of the Vendor/Bidder, or one of its parents, subsidiaries or affiliates, has engaged in regarding investment activities in Iran by completing the information requested below.

Entity Engage in Investment Activities _____

Relationship to Vendor/Bidder _____

Description of Activities

Duration of Engagement _____

Anticipate Cessation Date _____

Attach additional sheets if necessary _____

CERTIFICATION

I, the undersigned, certify that I am authorized to execute this certification on behalf of the Vendor, that the foregoing information and any attachments hereto, to the best of my knowledge are true and complete. I acknowledge that the South Jersey Port Corporation is relying on the information contained herein, and that the Vendor is under a continuing obligation from the date of this certification through the completion of any contract(s) with the SJPC to notify the SJPC in writing of any changes to the information contained herein; that I am aware that it is a criminal offense to make a false statement or misrepresentation in this certification. If I do so, I may be subject to criminal prosecution under the law, and it will constitute a material breach of my contract(s) with the SJPC, permitting the SJPC to declare any contract(s) resulting from this certification void and unenforceable.

Signature: _____

Date: _____

Print Name: _____

Print Title: _____

Rev. 12.13.2021

PLEASE BE ADVISED

New Jersey Election Law Enforcement Commission Requirements for ALL Bids and Requests for Proposals

All Business entities are advised of their responsibility to file an annual disclosure statement of political contributions with the New Jersey Election Law Enforcement Commission (ELEC) pursuant to N.J.S.A. 19:44A20.27 if they receive contracts in excess of \$50,000.00 from public entities in a calendar year. Business entities are responsible for determining if filing is necessary. Additional information on this requirement is available from ELEC at 888-313-3532 or at www.elec.state.nj.us.

DISCLOSURE OF CONTRIBUTIONS TO NEW JERSEY ELECTION LAW ENFORCEMENT COMMISSION IN ACCORDANCE WITH N.J.S.A. 19:44A-20.27

STATE OF _____

: SS

COUNTY OF _____

I, _____ of the _____ of _____ in the County of _____ and the State of _____ of full age, being duly sworn according to law on my oath depose and say that:

I am _____, a _____
(Name) (Title, Position, etc.)
in the firm of _____ the bidder making the proposal
to _____
(Name of Owner) (Contract No. – Description)

and that I executed the said Proposal with full Authority to do so; that said Bidder acknowledges our responsibility to file an annual disclosure statement of political contributions with the New Jersey Election Law Enforcement Commission (ELEC) pursuant to N.J.S.A. 19:44A-20.27 if in receipt of contracts in excess of \$50,000.00 from public entities in a calendar year. I further acknowledge that business entities are solely responsible for determining if filing is necessary and that all statements contained in said Proposal and in this Affidavit are true and correct, and made with full knowledge that the

(Name of Owner)

relies upon the truth of the statements contained in said Proposal and in the statements contained in this Affidavit in awarding the Contract for the said project.

I further warrant that no person or selling agency has been employed or retained to solicit or secure such contract upon an agreement or understanding for commission, percentage brokerage, or contingent fee, except Bona Fide employees of the Contractor, and as may be permitted by law.

Name: _____
(print)

Subscribed and Sworn to before me this _____ day of _____ 20__.

Notary Public of _____

My Commission Expires: _____

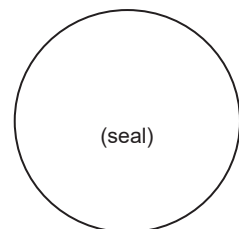



CERTIFICATION OF NON-INVOLVEMENT IN PROHIBITED ACTIVITIES IN RUSSIA OR BELARUS

CONTRACT TITLE _____
CONTRACT NUMBER _____

Pursuant to N.J.S.A. 52:32-60.1, et seq. (P.L. 2022, c. 3) any person or entity (hereinafter "Vendor"ⁱ) that seeks to enter into or renew a contract with a State agency for the provision of goods or services, or the purchase of bonds or other obligations, must complete the certification below indicating whether or not the Vendor is engaged in prohibited activities in Russia or Belarusⁱⁱ. If the Department of the Treasury finds that a Vendor has made a certification in violation of the law, it shall take any action as may be appropriate and provided by law, rule or contract, including but not limited to, imposing sanctions, seeking compliance, recovering damages, declaring the party in default and seeking debarment or suspension of the party.

CERTIFICATION

I, the undersigned, certify that I have read the definition of "Vendor" below, and have reviewed the [Department of the Treasury's list](#) of Vendors engaged in prohibited activities in Russia or Belarus, and having done so certify:

(Check the Appropriate Box)

- A. That the Vendor is not identified on the Department of the Treasury's list of Vendors engaged in prohibited activities in Russia or Belarus.
- OR**
- B. That I am unable to certify as to "A" above, because the Vendor is identified on the Department of the Treasury's list of Vendors engaged in prohibited activities in Russia and/or Belarus.
- OR**
- C. That I am unable to certify as to "A" above, because the Vendor, though not identified on the Department of the Treasury's list of Vendors engaged in prohibited activities in Russia or Belarus, is engaged in prohibited activities in Russia or Belarus. A detailed, accurate and precise description of the Vendor's activity in Russia and/or Belarus is set forth below.
Description of Prohibited Activity *(Attach Additional Sheets If Necessary.)*

Additional Certification of Federal Exemption and/or License

(Complete only if appropriate)

- D. I, the undersigned, certify that Vendor is currently engaged in activity in Russia and/or Belarus, but is doing so consistent with federal law and/or regulation and/or license. A detailed description of how the Vendor's activity in Russia and/or Belarus is consistent with federal law, or is within the requirements of the federal exemption and/or license is set forth below. *(Attach Additional Sheets If Necessary.)*

Signature of Vendor's Authorized Representative	Date
Print Name and Title of Vendor's Authorized Representative	Vendor's FEIN
Vendor's Name	Vendor's Phone Number
Vendor's Address (Street Address)	Vendor's Fax Number
Vendor's Address (City/State/Zip Code)	Vendor's Email Address

Definitions

ⁱ Vendor means: (1) A natural person, corporation, company, limited partnership, limited liability partnership, limited liability company, business association, sole proprietorship, joint venture, partnership, society, trust, or any other nongovernmental entity, organization, or group; (2) Any governmental entity or instrumentality of a government, including a multilateral development institution, as defined in Section 1701(c)(3) of the International Financial Institutions Act, 22 U.S.C. 262r(c)(3); or (3) Any parent, successor, subunit, direct or indirect subsidiary, or any entity under common ownership or control with, any entity described in paragraph (1) or (2).

ⁱⁱ Engaged in prohibited activities in Russia or Belarus means: (1) companies in which the Government of Russia or Belarus has any direct equity share; (2) having any business operations commencing after the effective date of this act that involve contracts with or the provision of goods or services to the Government of Russia or Belarus; (3) being headquartered in Russia or having its principal place of business in Russia or Belarus, or (4) supporting, assisting or facilitating the Government of Russia or Belarus in their campaigns to invade the sovereign country of Ukraine, either through in-kind support or for profit.

NEW JERSEY’S DIANE B. ALLEN EQUAL PAY ACT ACKNOWLEDGEMENT

Pursuant to the DIANE B. ALLEN EQUAL PAY ACT, N.J.S.A. 34:11-56.14.b., the Contractor shall provide to the Commissioner of the New Jersey Department of Labor and Workforce Development, through certified payroll records required pursuant to N.J.S.A. 34:11-56.25 et seq., information regarding the gender, race, job title, occupational category, and rate of total compensation of every employee of the employer employed in the State in connection with the contract. The Contractor shall provide the Commissioner, throughout the duration of the contract with an update to the information whenever payroll records are required to be submitted pursuant to N.J.S.A. 34:11-56.25 et seq.

Information regarding the Diane B. Allen Equal Pay Act and its requirements may be obtained from the New Jersey Department of Labor and Workforce Development (LWD) web site at: <https://nj.gov/labor/equalpay/equalpay.html>

LWD forms may be obtained from the online web site at: https://nj.gov/labor/forms_pdfs/equalpayact/MW-562withoutfein.pdf

The undersigned is an (individual) (partnership) (corporation) under the Laws of the State of _____ having principal offices at _____.

(Signed)

(Name - Type or Print)

(Company Name)

(Address)

(Telephone Number)

CHAPTER 60
PREVAILING WAGES FOR PUBLIC WORKS

SUBCHAPTER 9. ASSURANCES FOR PAYMENT OF PREVAILING WAGE

12:60-9.1 Certification by bidder with lowest bid by 10 percent or more

(a) When a public body engages in competitive bidding for public work subject to the provisions of the New Jersey Prevailing Wage Act (PWA), the person who makes the lowest bid for the contract by 10 percent or more under the amount of the next lowest bid shall prior to award of the contract certify to the public body on the form found at N.J.A.C. 12:60 Appendix that the prevailing wage rates required by the PWA shall be paid in performing the work under the contract.

(b) If the bidder does not provide the certification required pursuant to (a) above prior to the award of the contract, the public body shall award the contract to the next lowest responsible and responsive bidder.

12:60-9.2 Required contract provisions concerning payment of prevailing wage

(a) Every contract for the performance of public work shall contain the following contract provisions:

1. "Attached hereto and incorporated herein is(are) the Department of Labor and Workforce Development prevailing wage determination(s) for the locality and craft(s) that will be employed in the performance of work under this contract. It is hereby stipulated that each individual who performs work under this contract shall be paid not less than the prevailing wage rate to which that worker is entitled under the New Jersey Prevailing Wage Act, as reflected in the appropriate Department of Labor and Workforce Development prevailing wage determination"; and

2. "In the event it is found that any worker employed by the contractor or any subcontractor covered by this contract has been paid a rate of wages less than the prevailing wage rate required to be paid by this contract, the public body, the lessee to whom the public body is leasing a property or premises or the lessor from whom the public body is leasing or will be leasing a property or premises may terminate the contractor's or subcontractor's right to proceed with the work, or such part of the work as to which there has been a failure to pay required wages, and to prosecute the work to completion or otherwise. The contractor and his sureties shall be liable to the public body, any lessee to whom the public body is leasing a property or premises, or to any lessor from whom the public body is leasing or will be leasing a property or premises for any excess costs occasioned by the termination of the contractor's or subcontractor's right to proceed with the work, or such part of the work as to which there has been a failure to pay required wages."

APPENDIX
54 N.J.R. 1009(a)

In the matter of an award) STATE OF NEW JERSEY
of a)
contract for public work for) DEPARTMENT OF LABOR AND
a)
project described as:) WORKFORCE DEVELOPMENT
) DIVISION OF WAGE &
)
[Enter project description) HOUR COMPLIANCE
here])
)
)
) Certification of Lowest Bidder

LOWEST BIDDER PREVAILING WAGE CERTIFICATION

_____, of full age and under oath, duly provides the following sworn statement:

(1). I am the owner and/or highest-ranking official or officer of a company or firm named _____, which holds a currently valid public works contractor registration pursuant to the New Jersey Public Works Contractor Registration Act, N.J.S.A. 34:11-56.48 et seq., certificate number _____.

(2). I submitted a bid for a contract award in the above identified project and the public body has informed me that I am the lowest bidder by 10 percent or more as compared to the next lowest bid submitted.

(3). The amount of my bid does include paying the prevailing wage rate to all workers who perform work on the project at rates of pay, including both base wage and fringe benefits, set forth in applicable Wage Determinations, (1) for the appropriate locality, (2) for the appropriate work classification (e.g., carpenter, electrician, mason, plumber), and (3) for the appropriate job title (e.g., Apprentice, Journeyman, Forman), published by the New Jersey Department of Labor and Workforce Development (NJDOL) pursuant to the New Jersey Prevailing Wage Act (NJPWA), N.J.S.A. 34:11-56.25 et seq., and corresponding NJDOL rules, N.J.A.C. 12:60.

I certify under penalty of perjury that the foregoing statements made by me are true. I am aware that if any of the foregoing statements made by me are false, I am subject to punishment. See N.J.S.A. 2C:28-1 et seq., specifically, N.J.S.A. 2C:28-3, within the New Jersey Code of Criminal Justice.

Dated: _____ Signature: _____

Title: _____



CONFIDENTIALITY AND COMMITMENT TO DEFEND

STATE OF NEW JERSEY
DEPARTMENT OF THE TREASURY - DIVISION OF PURCHASE AND PROPERTY
33 WEST STATE STREET, P.O. BOX 230 TRENTON, NEW JERSEY 08625-0230

BID SOLICITATION # & TITLE: _____

The Bid Solicitation advises Bidders (hereinafter "Company") that the submitted "Quotes can be released to the public pursuant to N.J.A.C. 17:12-1.2(b) and (c), or under the New Jersey Open Public Records Act (OPRA), N.J.S.A. 47:1A-1.1 et seq., or the common law right to know." In the event that the Division receives a request for documents related to above referenced Bid Solicitation, in accordance with its statutory obligations under the New Jersey Open Public Records Act and/or the common law right to know, it is the Division's intent to fulfill the request for records which may include a copy of the Company's Quote.

If Company objects to the disclosure of any portions of the Quote, the Company must advise the Division and must attach a detailed statement clearly identifying those sections of the Quote that Company claims are exempt from disclosure. In requesting any exemption, Company must identify the specific statutory or other legal justification for each requested exemption and the factual basis that supports said exemption. In addition, if Company requests any exemption to disclosure of the Quote based upon claims of confidential/proprietary information and trade secrets (setting forth the nature of the formula, process, pattern, device or compilation), in accordance with *Ingersoll-Rand Co. v. Ciavatta*, 110 N.J. 609 (1988), Company must also indicate the following with respect to the requested exemption:

- (1) the extent to which the information is known outside the owner's business;
- (2) the extent to which it is known by employees and others involved with your business;
- (3) the extent of the measures taken by your firm to guard the secrecy of the information;
- (4) the value of the information to your firm and your competitors;
- (5) the amount of effort or money expended by your firm in developing the information; and
- (6) the ease or difficulty with which the information could be properly acquired or duplicated by others.

Further, if the Quote includes any copyright notices, within five business days, the Division will be permitted to release a copy of the Quote document(s) unless Company serves the Division with an order from a court of competent jurisdiction precluding such release.

The State reserves the right to make the final determination as to what is and is not subject to public disclosure under OPRA and/or the common law right to know, and will advise the Company accordingly. Please note that the State will not honor any claim of confidential, proprietary, trade secret, and/or copyright material that is not supported by a specific statutory or legal justification provided by the Company. The State will not honor any attempts by the Company to designate the entire Quote as proprietary, confidential and/or to claim copyright protection for its entire Quote.

Accordingly, in order to assist the Division with the fulfillment of potential document requests, please select **one** of the following:

- The Company's Quote **does not include** any confidential, proprietary and/or trade secrets; and therefore, the Company does not request any redactions be made prior to the release of the documents.
- OR**
- The Company's Quote **does include** confidential, proprietary and/or trade secrets; and therefore, the Company requests that certain portions of the Quote be redacted prior to the release of the documents.

The requested redactions are set forth in the attached statement which specifically identifies the portions of the Quote by section, page number, paragraph and or line; and identifies the specific statutory or other legal reason for each requested exemption.

In the event of any challenge to the Company's assertion of confidential/proprietary information, the Company shall be solely responsible for defending its designation. Company agrees that it shall defend and cooperate in the defense of an action against the State of New Jersey arising from or related to the non-disclosure, due to the Company's request, of documents submitted to the State of New Jersey, and relating to a Quote submitted by the Company in response to the above referenced Bid Solicitation, which was the subject of a request for government records under the New Jersey Open Public Records Act, N.J.S.A. 47:1A-1 et seq. ("OPRA"), or the common law right to know. The Company further agrees to indemnify and hold harmless the State against any judgments, costs, or attorneys' fees assessed against the State in connection with any action arising from, or related to, the non-disclosure, due to the Company's request, of documents submitted to the State, which are the subject of a request for government records under OPRA.

The Company makes the forgoing agreement with the understanding that the State may immediately disclose any documents withheld without further notice if the Company ceases to cooperate in the defense of an action against the State arising from or related to the above described non-disclosure due to the Company's request, and will disclose such documents withheld if so ordered by a court of competent jurisdiction.

The undersigned certifies that s/he is duly authorized to make this commitment on behalf of the Company.

Company Name

Signature

Date

Print Name and Title



DISCLOSURE OF INVESTIGATIONS AND OTHER ACTIONS INVOLVING THE VENDOR FORM

STATE OF NEW JERSEY
DEPARTMENT OF THE TREASURY - DIVISION OF PURCHASE AND PROPERTY
33 WEST STATE STREET, P.O. BOX 230 TRENTON, NEW JERSEY 08625-0230

BID SOLICITATION # AND TITLE: _____

VENDOR NAME: _____

PART 1

PLEASE LIST ALL OFFICERS/DIRECTORS OF THE VENDOR BELOW.

NAME
TITLE
ADDRESS
ADDRESS
CITY STATE ZIP

NAME
TITLE
ADDRESS
ADDRESS
CITY STATE ZIP

NAME
TITLE
ADDRESS
ADDRESS
CITY STATE ZIP

NAME
TITLE
ADDRESS
ADDRESS
CITY STATE ZIP

*Attach Additional Sheets If Necessary.

PART 2

PLEASE REFER TO THE PERSONS LISTED ABOVE AND/OR THE PERSONS AND/OR ENTITIES LISTED ON THE OWNERSHIP DISCLOSURE FORM WHEN ANSWERING THESE QUESTIONS.

- 1. Has any person or entity listed on this form or its attachments ever been arrested, charged, indicted, or convicted in a criminal or disorderly persons matter by the State of New Jersey (or political subdivision thereof), or by any other state or the U.S. Government?
2. Has any person or entity listed on this form or its attachments ever been suspended, debarred or otherwise declared ineligible by any government agency from bidding or contracting to provide services, labor, materials or supplies?
3. Are there currently any pending criminal matters or debarment proceedings in which the firm and/or its officers and/or managers are involved?
4. Has any person or entity listed on this form or its attachments been denied any license, permit or similar authorization required to engage in the work applied for herein, or has any such license, permit or similar authorization been revoked by any agency of federal, state or local government?
5. Has any person or entity listed on this form or its attachments been involved as an adverse party to a public sector client in any civil litigation or administrative proceeding in the past five (5) years?

IF ANY OF THE ANSWERS TO QUESTIONS 1-5 ARE "YES", PLEASE PROVIDE THE REQUESTED INFORMATION IN PART 3.
IF ALL OF THE ANSWERS TO QUESTIONS 1-5 ARE "NO", NO FURTHER ACTION IS NEEDED; PLEASE SIGN AND DATE THE FORM.

PART 3

DESCRIPTION OF THE INVESTIGATION OR LITIGATION, ETC.

If you answered "YES" to any of questions 1 - 5 above, you must provide a detailed description of any investigation or litigation, including, but not limited to, administrative complaints or other administrative proceedings involving public sector clients during the past five (5) years. The description must include the nature and status of the investigation, and for any litigation, the caption and a brief description of the action, the date of inception, current status, and if applicable, the disposition.

PERSON OR ENTITY NAME
CONTACT NAME PHONE NUMBER
CASE CAPTION
INCEPTION OF THE INVESTIGATION CURRENT STATUS
SUMMARY OF INVESTIGATION

*Attach Additional Sheets If Necessary.

CERTIFICATION

I, the undersigned, certify that I am authorized to execute this certification on behalf of the Vendor, that the foregoing information and any attachments hereto, to the best of my knowledge are true and complete. I acknowledge that the State of New Jersey is relying on the information contained herein, and that the Vendor is under a continuing obligation from the date of this certification through the completion of any contract(s) with the State to notify the State in writing of any changes to the information contained herein; that I am aware that it is a criminal offense to make a false statement or misrepresentation in this certification. If I do so, I may be subject to criminal prosecution under the law, and it will constitute a material breach of my contract(s) with the State, permitting the State to declare any contract(s) resulting from this certification void and unenforceable.

Signature

Date

Print Name and Title



MACBRIDE PRINCIPLES FORM

Q29

STATE OF NEW JERSEY
DEPARTMENT OF THE TREASURY - DIVISION OF PURCHASE AND PROPERTY
33 WEST STATE STREET, P.O. BOX 230 TRENTON, NEW JERSEY 08625-0230

BID SOLICITATION # AND TITLE: _____

VENDOR NAME: _____

Pursuant to Public Law 1995, c. 134, a responsible Vendor/Bidder is required to provide a certification in compliance with the MacBride Principles and Northern Ireland Act of 1989. Pursuant to N.J.S.A. 52:34-12.2, Vendor/Bidder must complete the certification below by checking one of the two options listed below and signing where indicated. If a Vendor/Bidder that would otherwise be awarded a purchase, contract or agreement does not complete the certification, then the Director may determine, in accordance with applicable law and rules, that it is in the best interest of the State to award the purchase, contract or agreement to another Vendor/Bidder that has completed the certification and has submitted a bid within five (5) percent of the most advantageous bid. If the Director finds contractors to be in violation of the principles that are the subject of this law, he/she shall take such action as may be appropriate and provided by law, rule or contract, including but not limited to, imposing sanctions, seeking compliance, recovering damages, declaring the party in default and seeking debarment or suspension of the party.

I, the undersigned, on behalf the Vendor/Bidder, certify pursuant to N.J.S.A. 52:34-12.2 that:

CHECK THE APPROPRIATE BOX

The Vendor/Bidder has no business operations in Northern Ireland; or

OR

The Vendor/Bidder will take lawful steps in good faith to conduct any business operations it has in Northern Ireland in accordance with the MacBride principles of nondiscrimination in employment as set forth in section 2 of P.L. 1987, c. 177 (N.J.S.A. 52:18A-89.5) and in conformance with the United Kingdom's Fair Employment (Northern Ireland) Act of 1989, and permit independent monitoring of its compliance with those principles.

CERTIFICATION

I, the undersigned, certify that I am authorized to execute this certification on behalf of the Vendor, that the foregoing information and any attachments hereto, to the best of my knowledge are true and complete. I acknowledge that the State of New Jersey is relying on the information contained herein, and that the Vendor is under a continuing obligation from the date of this certification through the completion of any contract(s) with the State to notify the State in writing of any changes to the information contained herein; that I am aware that it is a criminal offense to make a false statement or misrepresentation in this certification. If I do so, I may be subject to criminal prosecution under the law, and it will constitute a material breach of my contract(s) with the State, permitting the State to declare any contract(s) resulting from this certification void and unenforceable.

Signature

Date

Print Name and Title



**SAMPLE AGREEMENT FOR PROFESSIONAL
SERVICES BETWEEN THE
SOUTH JERSEY PORT CORPORATION
AND**

THIS PROFESSIONAL SERVICES AGREEMENT (hereinafter the “Agreement”) is made as of this ___ day of ___, **2023** (the “Effective Date”) by and between _____, with principal offices located at _____, hereinafter referred to as “Contractor,” and **SOUTH JERSEY PORT CORPORATION**, a public body corporate and politic constituting an instrumentality of the State of New Jersey, with principal offices located at Two Aquarium Drive, Suite 100, Camden, NJ 08103, hereinafter referred to as “SJPC”.

RECITALS

WHEREAS, there exists a need by the SJPC to contract for _____, as needed (hereinafter the “Project”), as per SJPC Request for Proposal Number _____ (hereinafter the “RFP”);

WHEREAS, pursuant to the RFP, and the Contractor’s proposal thereto dated _____ (hereinafter the “Proposal”), the SJPC has selected the Contractor to serve as _____ to and for the SJPC to provide _____, as outlined in the RFP, as and when determined and requested by the SJPC in its sole discretion (hereinafter the “Services”);

WHEREAS, Contractor represents that it is qualified to perform the Services, and desires to so perform pursuant to the terms and provisions of this Agreement; and,

WHEREAS, this Agreement is awarded pursuant to, and consistent with, the South Jersey Port Corporation Act, N.J.S.A. 12:11A-1, et seq., and any statutes, administrative regulations, rules, and internal procedures governing SJPC’s procurement process; and,

WHEREAS, pursuant to SJPC Board action on _____, the SJPC desires to engage, and the Contractor desires to accept the engagement to provide the Services, all as more particularly set forth in this Agreement.

NOW, THEREFORE, in consideration of the mutual covenants and agreements contained herein, and for other good and valuable consideration the receipt of which is hereby

acknowledged, the SJPC and the Contractor intending to be legally bound, hereby agree as follows:

TERMS OF AGREEMENT

1. **TERM.** The initial term of this Agreement shall commence on the Effective Date and shall expire _____ year thereafter (hereinafter the “Termination Date”), unless terminated sooner by SJPC as set forth in this Agreement; provided however, that this Agreement shall remain in full force and effect for any Services requested by SJPC prior to the Termination Date and performed with the written consent of SJPC by the Contractor after the Termination Date (“Post Termination Services”). The SJPC shall have the option in its sole discretion to extend the term of this Agreement for _____ under the same terms and conditions by providing written notice to the Contractor prior to the Termination Date.

2. **SERVICES AND COMPENSATION IN GENERAL.** Copies of the RFP and the Proposal are annexed hereto as **Exhibits A and B** respectively. By this reference, the RFP and the Proposal are incorporated in and made a part of this Agreement, as if set forth herein in full. In case of conflict or inconsistency between the provisions of the RFP and Proposal on the one hand, and this Agreement on the other hand, the provisions of this Agreement shall govern to the extent of such conflict or inconsistency. In the event of an inconsistency between the RFP and the Proposal, the RFP shall govern.

The Contractor, in consideration of the execution and delivery of this Agreement, agrees to render the Services, as more fully described in the RFP and the Proposal. Contractor shall hold available to SJPC all officers, employees and facilities of Contractor to perform all the Services, as required and requested by SJPC, as more fully set forth in the RFP and Proposal. The employees listed in the Proposal will be the employees primarily responsible for SJPC matters, although other employees of the Contractor may work on SJPC matters. The SJPC shall compensate Contractor for the Services requested by SJPC, and performed by Contractor, in accordance with the terms of this Agreement, and as set forth in the Proposal.

3. **COMPENSATION.** Contractor shall be compensated in a total amount *not to exceed* _____ per year at hourly rates set forth in the Proposal.

Contractor shall be paid in accordance with this Agreement upon receipt and processing of an invoice as set out herein. Each invoice shall contain an itemized, detailed description of all work performed during the billing period. Failure to provide sufficient

specificity shall be cause for rejection of the invoice until the necessary details are provided.

All costs and expenses incurred by Contractor shall be borne solely by Contractor unless specifically reimbursable under another provision of this Agreement, or specifically authorized in writing by the SJPC.

All services rendered by the Contractor will be compensated on the basis of the hourly rates for personnel performing the services, as set forth in the Proposal.

The SJPC will make payment to the Contractor for services rendered on SJPC matters at the rates described in the Proposal. The SJPC will be billed for all time spent on its behalf. The Contractor's invoices shall set forth the time spent by each employee, a detailed description of all work performed, and the amount of the fees and certain other charges that are reimbursable under the Proposal. Invoices normally will be rendered monthly for work performed, and any reimbursable charges and expenses recorded during the previous month. The SJPC will pay each invoice after approval by the SJPC Board of Directors and expiration of the Governor's veto period, unless the SJPC disputes the invoice, in which event the SJPC will notify the Contractor of such dispute within twenty (20) days of expiration of the Governor's veto period.

The Contractor shall not charge, and the SJPC shall not be obligated to pay, any fees, costs or expenses not detailed in this Agreement unless pre-approved by the SJPC in writing. SJPC shall not be obligated or liable under this Agreement to any party, other than the Contractor, for the payment of any monies or the provision of any goods or services.

It is understood and agreed that the acceptance of the final payment by Contractor shall be considered a release in full of all claims against the SJPC arising out of, or by reason of, the Services furnished under this Agreement.

4. **DUTIES OF CONTRACTOR.** Contractor shall, at the request of the SJPC, provide the Services as specified in the RFP and Proposal. Contractor's Services are for the sole and exclusive benefit of the SJPC, and no third-party beneficiary is intended. The provision of these Services by Contractor shall not relieve others of their responsibility to the SJPC. Contractor agrees that it has or will comply with, and where applicable shall continue throughout the period of this Agreement to comply with, all of the requirements of the RFP, and this Agreement. Pursuant to the RFP, Contractor may be requested to prepare design documents, or other such drawings and/or written specifications for a project, all of which will be subject to SJPC's review and reasonable approval. If SJPC requests revisions to the design documents, drawings or written specifications prepared by Contractor, and if same is within the Contractor's scope of services as described in the RFP, Contractor shall make the requested revisions without additional compensation, such that Contractor performs the Services, and prepares the design documents, drawings and/or written specifications in accordance with this Agreement.

The Contractor shall respond to only those requests for Services made by the SJPC's authorized representatives; but in no case shall respond to, or provide any Services hereunder, upon the request of any private citizen, person, firm, or other entity, except as expressly authorized by the SJPC.

The original files pertaining to SJPC matters in the possession of the Contractor, including, but not limited to, finished or unfinished data compilations, drawings, engineering plans, specifications, studies, and all such other documents/materials prepared for SJPC, shall be the property of SJPC; and same shall all be promptly delivered by Contractor to the SJPC upon termination of this Agreement.

5. **EEO OBLIGATIONS OF THE CONTRACTOR.** During the performance of this Agreement, the Contractor agrees as follows:

The Contractor or subcontractor, where applicable, will not discriminate against any employee or applicant for employment because of age, race, creed, color, national origin, ancestry, marital status, affectional or sexual orientation, gender identity or expression, disability, nationality or sex. Except with respect to affectional or sexual orientation and gender identity or expression, the Contractor will ensure that equal employment opportunity is afforded to such applicants in recruitment and employment, and that employees are treated during employment, without regard to their age, race, creed, color, national origin, ancestry, marital status, affectional or sexual orientation, gender identity or expression, disability, nationality, or sex. Such equal employment opportunity shall include, but not be limited to, the following: employment, upgrading, demotion or transfer; recruitment or recruitment advertising; layoff or termination; rates of pay or other forms of compensation; and selection for training, including apprenticeship. The Contractor agrees to post in conspicuous places, available to employees and applicants for employment, notices to be provided by the SJPC's Compliance Officer setting forth provisions of this nondiscrimination clause.

The Contractor or subcontractor, where applicable will, in all solicitations or advertisements for employees placed by or on behalf of the Contractor, state that all qualified applicants will receive consideration for employment without regard to age, race, creed, color, national origin, ancestry, marital status, affectional or sexual orientation, gender identity or expression, disability, nationality, or sex.

The Contractor or subcontractor, where applicable will send to each labor union with which it has a collective bargaining agreement, a notice, to be provided to the SJPC's contracting officer, advising the labor union of the Contractor's commitments under this chapter and shall post copies of notice in conspicuous places available to employees and applicants for employment.

The Contractor or subcontractor, where applicable agrees to comply with any regulations promulgated by the Treasurer pursuant to N.J.S.A. 10:5-31, et. seq., as amended and supplemented from time to time and the Americans with Disabilities Act.

The Contractor or subcontractor, where applicable agrees to make good faith efforts to meet targeted county employment goals established in accordance with N.J.A.C. 17:27-5.2.

The Contractor or subcontractor, where applicable agrees to inform in writing its appropriate recruitment agencies, including, but not limited to, employment agencies, placement bureaus, colleges, universities labor unions, that it does not discriminate on the basis of age, race, creed, color, national origin, ancestry, marital status, affectional or sexual orientation, gender identity or expression, disability, nationality, or sex, and that it will discontinue the use of any recruitment agency which engages in direct or indirect discriminatory practices.

The Contractor or subcontractor, as applicable agrees to revise any of its testing procedures, if necessary, to assure that all personnel testing conforms with the principles of job-related testing, as established by the statutes and court decisions of the State of New Jersey and as established by applicable Federal law and applicable Federal court decisions.

In conforming with the targeted employment goals, the Contractor or subcontractor, where applicable agrees to review all procedures relating to transfer, upgrading, downgrading and layoff to ensure that all such actions are taken without regard to age, race, creed, color, national origin, ancestry, marital status, affectional or sexual orientation, gender identity or expression, disability, nationality or sex, consistent with the statutes and court decisions of the State of New Jersey, and applicable Federal law and applicable Federal court decisions.

The Contractor shall submit to the SJPC after notification of award, but prior to execution of a goods and services contract, one of the following three documents:

Letter of Federal Affirmative Action Plan Approval;
Certificate of Employee Information Report; or,
Employee Information Report Form AA-302.

The Contractor and its subcontractors, if any, shall furnish such reports or other documents to the Division of Purchase and Property, CCAU, EEO Monitoring Program as may be requested by the office from time to time in order to carry out the purposes of these regulations, and the SJPC shall furnish such information as may be requested by the

Division of Purchase and Property, CCAU, EEO Monitoring Program for conducting a compliance investigation pursuant to N.J.A.C. 17:27-1.1, et seq.

6. **LICENSING.** If the Contractor, or any of its employees, is required to maintain a license or certification in order to perform the Services which are the subject of this Agreement, then prior to the effective date of this Agreement, and as a condition precedent to it taking effect, Contractor and its employees shall maintain, hold, and have in place all such current licenses and certifications required to do business and/or operate in the State of New Jersey, and to perform all the Services hereunder. Contractor shall provide to SJPC upon request a copy of all its and its employees said current licenses and/or certifications. All current licenses and/or certifications of the Contractor, or its employees, shall be in good standing, and shall not be subject to any current action to revoke or suspend; and shall remain so throughout the term of this Agreement, and any extensions.

The Contractor shall notify the SJPC immediately in the event of suspension, revocation or any change in status (or in the event of the initiation of any action to accomplish such suspension, revocation and/or change in status) of the license or certification held by Contractor, or any of its employees.

7. **TERMINATION.** This Agreement may be terminated, as follows:
- (a) Pursuant to the termination provisions set forth in the RFP, if any.
 - (b) If Contractor and/or its employees is required to be licensed or to maintain any certification in order to perform the Services, then this Agreement may be terminated by the SJPC in the event that the appropriate governmental entity with jurisdiction has instituted an action to have the Contractor's or its employees license or certification suspended or revoked. Notice of termination pursuant to this provision shall be effective immediately upon giving of the written notice.
 - (c) If, through any cause, the Contractor shall fail to fulfill in timely and proper manner its obligations under this Agreement, or if the Contractor shall violate any of the covenants, agreements or stipulations of this Agreement, the SJPC shall thereupon have the right to terminate this Agreement by giving written notice to the Contractor of such termination and specifying the effective date thereof.
 - (d) The SJPC may terminate this Agreement for public convenience at any time by giving written notice to the Contractor of such termination and specifying the effective date thereof. If this Agreement is terminated by the SJPC pursuant to this provision, the Contractor will be paid for the Services rendered to the time of termination.
 - (e) Notwithstanding any of the above, the Contractor shall not be relieved of liability to the SJPC for damages sustained by the SJPC by virtue of any breach of this

Agreement by the Contractor; and the SJPC may withhold any payments to the Contractor for the purpose of set-off until such time as the exact amount of damages due the SJPC from the Contractors is determined.

- (f) Termination by the SJPC of this Agreement shall not affect the validity of the indemnification provisions of this Agreement, nor prevent the SJPC from pursuing any claims, causes of action, relief, damages or remedies to which it may be entitled, either at law or in equity.
- (g) Termination of this Agreement shall not affect any right or obligation of any party which is accrued or vested prior to the termination, and any provision of this Agreement relating to any such right or obligation shall be deemed to survive the expiration or earlier termination of this Agreement.

8. **NO ASSIGNMENT OR SUBCONTRACT.** This Agreement may not be assigned nor subcontracted by the Contractor, except as otherwise agreed in writing by both parties. Any attempted assignment or subcontract without such written consent shall be void with respect to the SJPC, and no obligation on the SJPC's part to such assignment or subcontract shall arise, unless the SJPC shall elect to accept and consent to in writing, such assignment or subcontract

9. **CONFLICTS OF INTEREST.** The Contractor represents that it does not have an existing financial interest, and will not acquire any such interest, direct or indirect, which could conflict in any manner or degree with the performance of Services under this Agreement; and that no person having any such interest shall be subcontracted in connection with this Agreement or employed by the Contractor. The Contractor will also take all necessary steps to avoid the appearance of a conflict of interest and shall have the duty to disclose to the SJPC prior to entering into, and during the term of, this Agreement any and all circumstances existing at such time which pose a potential conflict of interest.

The Contractor warrants that it has not directly or indirectly offered or given and will not directly or indirectly offer or give to any employee, agent, servant or representative of the SJPC any cash or non-cash gratuity or payment with view toward securing any business from SJPC or influencing such person with respect to conditions, or performance of any agreements with or orders from SJPC, including without limitation this Agreement. Any breach of this warranty shall be a material breach of this Agreement, and each and every other agreement between SJPC and the Contractor.

Should a conflict-of-interest issue arise, the Contractor agrees to fully cooperate in any inquiry, and to provide SJPC or its designee with all documents and other information reasonably necessary to enable SJPC, or its designee, to determine whether or not a conflict of interest existed or exists. Failure to comply with the provisions of this

paragraph shall constitute grounds for immediate termination of this Agreement, in addition to whatever other remedies the SJPC may have.

10. INDEMNIFICATION. Contractor agrees to indemnify and hold harmless the SJPC, its respective directors, officers, and employees from and against any and all losses, claims, causes of action, damages, liabilities, obligations, penalties, judgements, awards, costs expenses and disbursements, including attorneys' fees and other legal expenses and costs, arising directly or indirectly from or in connection with, caused by, relating to, or based upon, any (i) any negligent, careless, reckless, or intentionally wrongful act or omission of the Contractor or Contractor's assistants, employees, contractors, servants or agents, (ii) a determination by a court or agency that the Contractor is not an independent contractor, (iii) any breach by the Contractor, or the Contractor's assistants, employees, contractors, servants or agents of this Agreement, (iv) any willful misconduct or gross negligence by the Contractor or the Contractor's assistants, employees, contractors, servants or agents under this Agreement, (v) any failure of the Contractor, or the Contractor's assistants, employees, contractors, servants or agents to perform the Services in accordance with all applicable laws, rules and regulations; or, (vi) any act by Contractor or the Contractor's assistants, employees contractors, servants, or agents in connection with Contractor's engagement by SJPC that is outside the scope of Contractor's authority hereunder.

This provision shall survive and continue in full force and effect after any expiration or earlier termination of this Agreement.

11. GOOD STANDING. By signing this Agreement, the Contractor certifies that the Contractor, and any of its principals (i) are not presently debarred, suspended, proposed for debarment, or declared ineligible for the award of agreements by any public agency, (ii) have not within a five-year period preceding this Agreement been convicted of or had a civil judgement rendered against them for: commission of fraud or a criminal offense in connection with obtaining, attempting to obtain, or performing a federal, state or local government agreement or subcontract; violation of federal or state antitrust statutes relating to the submission of offers; or commission of embezzlement, theft, forgery, bribery, falsification or destruction of records, making false statements, tax evasion, or racing stolen property; and are not present indicted for, or otherwise criminally or civilly charged by a government entity with, commission of any of these offenses.

12. INSURANCE. The Services shall not commence until the Contractor has obtained, at its own expense, all of the insurance required hereunder, and until such insurance has been approved in writing by the SJPC, or its designee. The Contractor shall not allow any subcontractor to commence work on any projects hereunder until all insurance required of the subcontractor has been so obtained and approved by the Contractor and provided to

and approved by the SJPC. Approval of the insurance required of the Contractor hereunder will be granted only after submission to SJPC of original Certificates of Insurance signed by authorized representatives of insurers or, at SJPC's request, after submission of certified copies of the required insurance policies, inclusive of additional insured and other required endorsements.

All insurance required hereunder shall be issued by insurance carriers rated A-, Class VIII, or better, by A.M. Best and Company, and licensed to do business in the State of New Jersey. All policies of insurance shall be endorsed to provide that the policy is not subject to cancellation, non-renewal, or material reduction in coverage until thirty (30) days prior written notice is given to the SJPC. The SJPC, and its board members, directors, officers, employees and agents shall be named as *Additional Insureds* on all policies and certificates of insurance for General Liability, Automobile Liability and Umbrella Liability required hereunder. All coverage provided by the policies required hereunder must be primary and non-contributory as to all insureds and *Additional Insureds*. The policies shall contain a waiver of subrogation in favor of the *Additional Insureds*.

Contractor agrees to continue the policies of insurance required hereunder in full force and effect during the term of this Agreement, any extensions, and for the period of the applicable statutes of limitation following termination of this Agreement.

No acceptance and/or approval of any insurance by the SJPC shall be construed as relieving or excusing the Contractor from any liability of obligation imposed upon them by the provisions of this Agreement, relieving the Contractor of the obligation to obtain and maintain the types and amounts of insurance coverage required hereunder.

The Contractor shall purchase and maintain the insurance types and minimum coverages as set forth in the RFP. Contractor shall furnish to SJPC with its signed original of this Agreement, an original Certificate of Insurance that evidence Contractor has met the insurance requirements of the RFP, as more particularly set forth on the **EXHIBIT C** attached hereto and incorporated herein by reference. SJPC may in its sole discretion make request for the Contractor to also submit certified copies of the required policies, as set forth hereunder.

13. **SET-OFF.** Should Contractor either refuse or neglect to perform the Services which Contractor is required to perform in accordance with the terms of this Agreement, and if expense is incurred by the SJPC by reason of Contractor's failure to perform, then in that event, such expenses shall be deducted from any payment due Contractor. Exercise of such right of set-off shall not operate to prevent the SJPC from pursuing any other remedy to which it may be entitled.

- 14. PREVENTION OF PERFORMANCE.** In the event that the SJPC is prevented from performing this Agreement by circumstances beyond its control, then any obligations owing by the SJPC to the Contractor shall be suspended without liability for the period during which the SJPC is so prevented.
- 15. INDEPENDENT CONTRACTOR STATUS.** Contractor is acting solely as an independent contractor hereunder, and has no authority to bind, represent, obligate or act on behalf of the SJPC. Contractor shall not be entitled to any benefits afforded by SJPC to its employees or to workers' compensation or similar benefits or insurance protection. Contractor, as an independent contractor, shall determine the method, details and means of performing any Services furnished pursuant to this Agreement, but the Services contemplated herein shall meet the approval of SJPC, and subject to the right of inspection for SJPC to secure satisfactory completion thereof.
- 16. MISCELLANEOUS.**
- (a) *Governing Law; Consent to Personal Jurisdiction.* This Agreement shall be governed by the laws of the State of New Jersey without regard to the conflicts of law provisions of any jurisdiction. The parties hereto hereby irrevocably and unconditionally consent to the exclusive jurisdiction and venue of the federal and state Courts located in Camden County, New Jersey for any action, suit or proceeding arising out of or related hereto. Each of the parties agrees not to commence any legal proceeding related hereto except in such Courts. Each of the parties irrevocably waives any objection which it may now or hereafter have to the laying of venue of any such proceeding in any such Courts, and hereby further irrevocably and unconditionally waives and agrees not to plead or claim in any such Courts that any such action, suit or proceeding brought in any such Court has been brought in an inconvenient forum. Each of the parties hereby irrevocably waives any right it may have to a trial by jury in any such action, suit or proceeding.
 - (b) *Binding Effect.* This Agreement shall inure to the benefit of, and be binding on the Contractor, the SJPC, and their respective permitted heirs, successors, assigns, administrators and other legal representatives. There are no third-party beneficiaries to this Agreement, except as expressly stated.
 - (c) *Entire Agreement.* This Agreement, together with the RFP and the Proposal, constitutes the entire agreement between the parties hereto, and supersedes any prior or contemporaneous written or oral understandings or agreements, and may be amended only by written amendment executed by both parties, and approved by the SJPC Board of Directors. This Agreement shall become effective and legally binding upon the signing of the Agreement by all parties hereto.
 - (d) *Disclosure.* Neither Contractor, nor any person or entity acting on behalf of Contractor, shall issue any press release or other public statement with respect to this Agreement, the terms hereof, or the Services contemplated hereunder.

- (e) *Notices.* All notices required or permitted to be given under this Agreement will be deemed sufficiently and validly made if given by certified mail, postage pre-paid, return receipt requested and regular mail, first-class **or** by overnight courier service, and addressed to the parties at their respective addresses set forth below:

As to SJPC: South Jersey Port Corporation
2 Aquarium Drive, Suite 100
Camden, NJ 08103
Attention: Andrew Saporito, Executive Director/CEO

As to Contractor:

- (f) *Modification, Waiver.* No modification of or amendment to this Agreement, nor any waiver of any rights under this Agreement, shall be effective unless in writing signed by all the parties. Waiver by the SJPC of a breach of any provision of this Agreement will not operate as a waiver of any other or subsequent breach, nor a bar to any subsequent enforcement.
- (g) *Taxes.* Contractor agrees that Contractor is solely responsible for paying when due all income taxes, including estimated taxes, payroll taxes, insurance, and other taxes incurred as a result of or in connection with the compensation paid by SJPC to Contractor for the Services under this Agreement; and no income or employment tax withholdings will be deducted from such payments.
- (h) *Headings.* Headings are used in this Agreement for reference only and shall not be considered when interpreting this Agreement.
- (i) *Severability.* If a Court or other body of competent jurisdiction finds, or the Parties mutually believe, any provision of this Agreement, or portion thereof, to be invalid or unenforceable, such provision will be enforced to the maximum extent permissible so as to affect the intent of the Parties, and the remainder of this Agreement will continue in full force and effect.
- (j) *Counterparts.* This Agreement may be signed in one (1) or more counterparts (whether original, facsimile or electronic copies), each of which when executed and delivered will constitute an original, but all of which will constitute one and the same Agreement.
- (k) *Construction.* Each of the parties agrees that it has had the opportunity to have this Agreement reviewed by their respective legal counsel. Accordingly, the rule of construction that any ambiguity in this Agreement is to be construed against the drafting party shall not apply.
- (l) *Survival.* All terms of this Agreement that expressly extend or by their nature should extend beyond termination or expiration of this Agreement, shall survive and

continue in full force and effect after any expiration or earlier termination of this Agreement.

THIS AGREEMENT is effective as of the date first above written.

IN WITNESS WHEREOF, the parties hereto have caused this Agreement to be executed and delivered by their duly authorized signatories as of the day and year first above written.

SOUTH JERSEY PORT CORPORATION

By: _____

Name: *Andrew Saporito*

Title: *Executive Director and CEO*

WITNESS:

By: _____

Name: _____

Title: _____

[INSERT FIRM NAME]

By: _____

Name: _____

Title: _____

WITNESS:

By: _____

Name: _____

Title: _____

EXHIBIT A

{RFP}

EXHIBIT B

{PROPOSAL}

EXHIBIT C

{INSURANCE REQUIREMENTS}



**REQUEST FOR SEALED BID PROPOSALS
SJPC 25-E19
ELECTRICAL SUBSTATION
INSPECTIONS, MAINTENANCE, AND REPAIRS
BROADWAY MARINE TERMINAL**

SCOPE OF WORK AND EXHIBITS

**SOUTH JERSEY PORT CORPORATION
2 Aquarium Drive, Suite 100
Camden, NJ 08103**

**SJPC - 25-E19
ELECTRICAL SUBSTATION
INSPECTION, MAINTENANCE, AND REPAIRS
BROADWAY MARINE TERMINAL**

SCOPE OF WORK

Introduction

The Broadway Marine Terminal is powered by an existing 26,000-volt substation. This facility is a unique “pass through” substation designed to enable the Port to receive a redundant electrical supply from two (2) different PSE&G distribution lines. It was constructed in 2001. Those drawings are attached as Exhibit A.

The substation was last serviced in 2021, so it is coming due for a scheduled maintenance. In addition, during a high voltage meter replacement on Saturday, March 8th, it was discovered that one of the two 5,000 KVA transformers was not energized. It is suspected that this condition might be due to a main breaker disconnect re-set issue resulting from a 26 KV dual service fault as recently experienced by PSE&G.

Therefore, the SJPC will engage a qualified electrical service firm to perform a complete inspection, maintenance, and repairs of the main electrical substation facilities at the Broadway Terminal on an expedited basis.

The project consists of inspection and preventative maintenance on one (1) line-up of 34.5 kv switchgear, two (2) step-down 5,000 kVA pad-mounted transformers, and two (2) sections of 5 kv switchgear.

1.1 SCOPE OF WORK

- A. Three (3) major items of electrical equipment presently in service at The South Jersey Port Corporation (SJPC) Broadway Terminal, 2500 Broadway, Camden NJ 08101 and installed in 2001 require preventive maintenance in order to continue in reliable service.

The specific equipment is listed as:

1. One (1) line-up of 34.5kv switchgear which comprises a feed-through and bypass of the Gloucester-to-Camden 26kv circuits by the electrical utility Public Service Electric and Gas Company (PSE&G) and which also serves as the primary service to the South Jersey Port Broadway Terminal.
2. Two (2) step-down 5000 kVA pad-mounted transformers rated 26.4kv to 4160Y/2400 volts which supply power to the Broadway Terminal's 5kv distribution switchgear.

3. Two (2) sections of 5kv switchgear connected by a source transfer-controlled tie and consisting of eleven (11) bays of 600-amp fused interrupter switches together with two (2) 1200-amp incoming line and (1) one 1200-amp tie switches.
- B. The subject equipment is located within a secure fenced-in area, known as the main switchyard, at the Broadway Terminal. Access to the switchyard is available from the SJPC Facilities Engineer.
 - C. It is critical that the PSE&G feed-through line be available and therefore any shut-down for maintenance purposes must be coordinated with PSE&G and preferably not exceeding eight (8) hours in duration.
 - D. It is also important that the SJPC Broadway Terminal be continually supplied with power as much as possible. Some flexibility for this is built into the 4160-volt electrical distribution system by means of the source transfer tie whereby each of the two (2) sections of 5kv switchgear can be separately powered from either of the two (2) transformers.
 - E. Maintenance procedures and recommendations are available from the equipment manufacturers. Manufacturer's drawings for all the equipment involved in this preventive maintenance program are available and selected excerpts are included in the REFERENCES section of these specifications.
 - F. Spare parts and replacement materials that are required to complete the preventive maintenance program are recommended by the manufacturer of the equipment and can be obtained from the representatives of the respective manufacturers.
 - G. Manufacturer's Representatives as follows:
 1. S & C Electric Company
Christopher Young
9 Roosevelt Way
Robbinsville, NJ 08691
609-490-1667 (office)
609-490-1668 (fax)
 2. Cooper Power Systems
Systems Control Associates, Inc.
1133 N. Providence Road
Media, PA 19063
610-565-2077

- H. It is anticipated that the work be performed when ambient temperatures are seasonally lower. Several of SJPC facilities consist of large refrigerated warehouses that cannot accept long periods without power when outside temperatures are above freezing.
- I. The work schedule is anticipated to be a “Week End” requirement, ie., performed on a Saturday.
- J. Scheduling of work requiring a power shutdown must be coordinated in advance with SJPC. In the cases where work is to be done on the 35-kV systems, both SJPC and PSE&G must be notified in advance of planned power shutdowns.
- K. Remove and install (labor only) 2 new CPTs within the 26 Kv High Voltage Cabinets. Materials were previously purchased and are on-site.
- L. Check all metering phase voltages, and remediate or repair as required.
- M. **The successful award will also include and require the “On-Call” Services of a High Voltage Electrical Contractor (>480 VAC) under a separate Time and Materials Rate Schedule to be included with the Bid Form, for a period of three years.**

1.2 CODES AND STANDARDS

- A. NFPA 70B Recommended Practice for Electrical Equipment Maintenance.
- B. Manufacturer’s published maintenance recommendations for their equipment.
- C. NETA Standards Level 4 Certification.

2.0 EQUIPMENT

2.1 35-kV OUTDOOR METAL ENCLOSED SWITCHGEAR

- A. Perform complete maintenance service inside and out on an existing installation of outdoor 35-kV metal-enclosed switchgear owned by SJPC and which is presently active and connected to a 26.4-kV distribution network operated by PSE&G.
- B. This equipment is manufactured by S&C Electric Company under the catalog number CDA-768103 and was installed in 2001.

- C. The switchgear is free standing and installed outdoors on a concrete pad within a fenced-in area. All cabling into and out of the switchgear is underground.
- D. Control and monitoring of the interrupter switch positions is accomplished by means of protective relaying which are remotely operated by PSE&G.
 - 1. Power to operate the relays is derived from a battery/charger system within the switchgear and supplied with charging power from SJPC Broadway Terminal facilities.
- F. A one-line diagram of the switchgear installation is included in the REFERENCE section of these specifications.
 - 1. The 35-kV installation consists of a total of twelve (12) bays.
 - 2. Two (2) 1200-amp, 34.5-kV interrupter switches as service disconnects with protective relaying and battery/chargers.
 - 3. Two (2) grounding switch/lightning arrester bays.
 - 4. Two (2) 1200-amp, 34.5-kV SF⁶ vacuum circuit breaker bays.
 - 5. Two (2) 1200-amp 34.5-kV, 3-pole, fused, power-operated line-out interrupter switches.
 - 6. Two (2) manually operated non-fused 1200-amp tie switches.
 - 7. Two (2) PT/CT and protective relaying bays.
 - 8. One (1) PSE&G revenue-metering cabinet.
 - 9. Complete installation drawings are stored within Bays 11 or 12.

3.1 5000-kVA PAD-MOUNTED TRANSFORMERS

- 3.1.1 Perform all preventive maintenance as listed below on two (2) existing in-service, oil-filled, pad-mounted transformers owned by SJPC each rated 5000-kVA, 26,400 volts delta primary – 4160Y/2400 volts secondary, with 6.49%Z.
- 3.1.2 Both transformers are manufactured by Cooper Power Systems, Waukesha, WI under Catalog No. 0008ZA68K05A.
 - 1. Unit #1 is S/N CP0126000300 and Unit #2 is S/N CP0126000301
- 3.1.3 Both transformers shipped on 3/16/2001 and were installed shortly after.

3.1.4 Nameplate, layout drawings, and factory test reports are included in the REFERENCE section of these specifications.

3.2 5-kV OUTDOOR METAL ENCLOSED SWITCHGEAR

3.2.1 Perform complete maintenance service inside and out on an existing, installation of outdoor 5-kV metal-enclosed switchgear configured as a double-ended distribution center presently active and connected to a pair of 5000 kVA 26.4-kV – 4160Y/2400V transformers.

3.2.2 This equipment is manufactured by S&C Electric Company under the Catalog Number CDA-769130 and was installed in 2001.

3.2.3 The switchgear is free standing installed outdoors on a concrete pad within a fenced-in area. All cabling into and out of the switchgear is underground.

3.2.4 This equipment consists of two (2) sections of 600-amp fused interrupter switch bays (a North section of six (6) bays and a South section of five (5) bays) connected by a 1200-amp non-fused motor-operated tie switch and two (2) 1200-amp non-fused motor-operated incoming line switches for a total of fourteen (14) switching bays.

3.2.5 A source transfer control circuitry prevents source paralleling and allows either source to provide power to the switchgear.

3.2.6 A One-Line Diagram of the 5-kV Switchgear is included in the REFERENCES section.

4.0 MAINTENANCE PROCEDURES, DETAILS ETC.

4.1 The following maintenance requirements are not intended as limiting the recommendations of the manufacturer or of NFPA70B and NETA, but are to aid in defining the work to be done for purposes of submitting bids.

4.2 35-kV Outdoor Metal Enclosed Switchgear

All Work While De-Energized.

Special Note: *PSE&G may require their representative to be present for certain maintenance operations; therefore, pre-op coordination with PSE&G is required to verify when this will be necessary.*

- 4.2.1.1 Schedule shutdowns by agreement with PSE&G and SJPC
- 4.2.1.2 Observe all pre-requisite grounding procedures before work
- 4.2.1.3 Check ventilation louvers and clean or replace air filters
- 4.2.1.4 Check cabinet interior for evidence of water leaks and reseal as required
- 4.2.1.5 Check bus splices and bolts for tightness
- 4.2.1.6 Inspect insulators and materials for surface tracking
- 4.2.1.7 Check condition and operation of space heaters
- 4.2.1.8 Check switch mechanism, blades and contacts for arcing, overall condition, alignment, etc.; lubricate moving parts.
- 4.2.1.9 Check power operators for functionality with respective relays
- 4.2.1.10 Clean and inspect cable terminations for tightness, surface tracking.
- 4.2.1.11 Inspect grounding connections and check bolts for tightness
- 4.2.1.12 Replace batteries and inspect and test chargers**
- 4.2.1.13 Check fuses and fuse clips
- 4.2.1.14 Test buses, PTs, CTs, and cables with high-potential dc
- 4.2.1.15 Test wiring for controls, meters, and protective relaying with meg-ohmmeter
- 4.2.1.16 Inspect cabinet surface for rust, scratches, dents; restore, repaint as required
- 4.2.1.17 Check proper operation of cabinet door locks, kirk interlocks and lubricate where necessary

4.2.2 5000-kVA Pad-Mounted Transformers

- 4.2.2.1 Read and note oil pressure, level, and temperature
- 4.2.2.2 Check for evidence of oil leaks
- 4.2.2.3 Visually inspect outside of unit for rust, dents, scratches or other damage
- 4.2.2.4 Open drain valve and take an oil sample for lab analysis
- 4.2.2.5 Record position of tap changer
- 4.2.2.6 Observe all pre-requisite grounding procedures before work
- 4.2.2.7 Inspect tank pressure relief device. Pressure test tank to check for leaks.
- 4.2.2.8 Check ground system connections
- 4.2.2.9 Check cable connections and tightness of termination bolts
- 4.2.2.10 Perform turns ratio and power factor tests
- 4.2.2.11 Perform turn-to-turn and phase-to-phase insulation test
- 4.2.2.12 Check bushings for evidence of tracking
- 4.2.2.13 Remove hand hole cover and lower liquid level for inspection of bushings
- 4.2.2.14 Inspect load tap changer and mechanism
- 4.2.2.15 Inspect bushings and internal connections
- 4.2.2.16 Replace insulating liquid to proper level per manufacturer's instructions
- 4.2.2.17 Replace and re-seal hand hole

- 4.2.2.18 Paint tank as required
- 4.2.2.19 5-kV Outdoor Metal Enclosed Switchgear
- 4.2.2.20 Schedule shutdowns by agreement with SJPC
- 4.2.2.21 Observe all pre-requisite grounding procedures before work
- 4.2.2.22 Check ventilation louvers and clean or replace air filters
- 4.2.2.23 Check cabinet interior for evidence of water leaks and reseal as required
- 4.2.2.24 Check bus splices and bolts for tightness
- 4.2.2.25 Inspect insulators and materials for surface tracking
- 4.2.2.26 Check condition and operation of space heaters
- 4.2.2.27 Check switch mechanism, blades and contacts for arcing, condition, alignment, etc.; lubricate moving parts
- 4.2.2.28 Check power operators for functionality
- 4.2.2.29 Clean and inspect cable terminations for tightness, surface tracking.
- 4.2.2.30 Inspect grounding connections and check bolts for tightness
- 4.2.2.31 Check fuses and fuse clips
- 4.2.2.33 Test buses, PTs, CTs, and cables with high-potential dc
- 4.2.2.34 Test wiring for controls, meters, and with meg-ohmmeter
- 4.2.2.35 Verify condition and operation of Satec metering
- 4.2.2.36 Inspect cabinet surface for rust, scratches, dents; restore, repaint as required
- 4.2.2.37 Check proper operation of cabinet door locks, kirk interlocks and lubricate where necessary.

5.0 REFERENCES

5.1 One-Line Diagram of the SJPC Broadway Terminal Facility Main Switchyard

5.2 S&C One-Line Drawing of 35-kV Switchgear

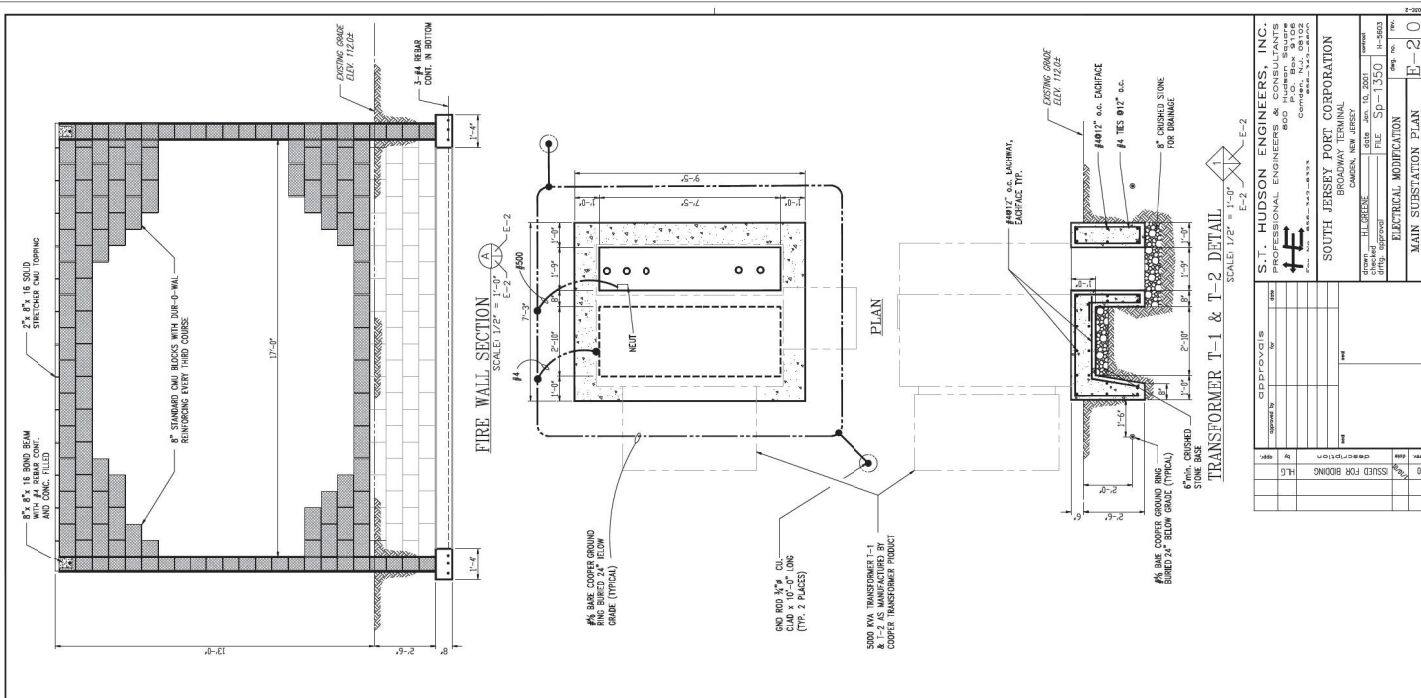

S.T. HUDSON ENGINEERS, INC.		SOUTH JERSEY PORT CORPORATION	
PROFESSIONAL ENGINEERS & CONSULTANTS		BROADWAY TERMINAL	
HUDSON ENGINEERING CORPORATION		CAMDEN, NEW JERSEY	
2000 BROADWAY		FILE NO. 50-1350	
NEWARK, N.J. 08102		DATE: 05/20/01	
PROJECT NO. 010000		DRAWING NO. E-20	
DATE: 05/20/01		SCALE: 1/2" = 1'-0"	
DRAWN BY: JLL/RLN		CHECKED BY: JLL/RLN	
DESIGNED BY: JLL/RLN		APPROVED BY: JLL/RLN	
DATE: 05/20/01		DATE: 05/20/01	
PROJECT: ELECTRICAL MODIFICATION		SHEET NO. E-20	
DRAWING TITLE: MAIN SUBSTATION PLAN		SCALE: 1/4" = 1'-0"	

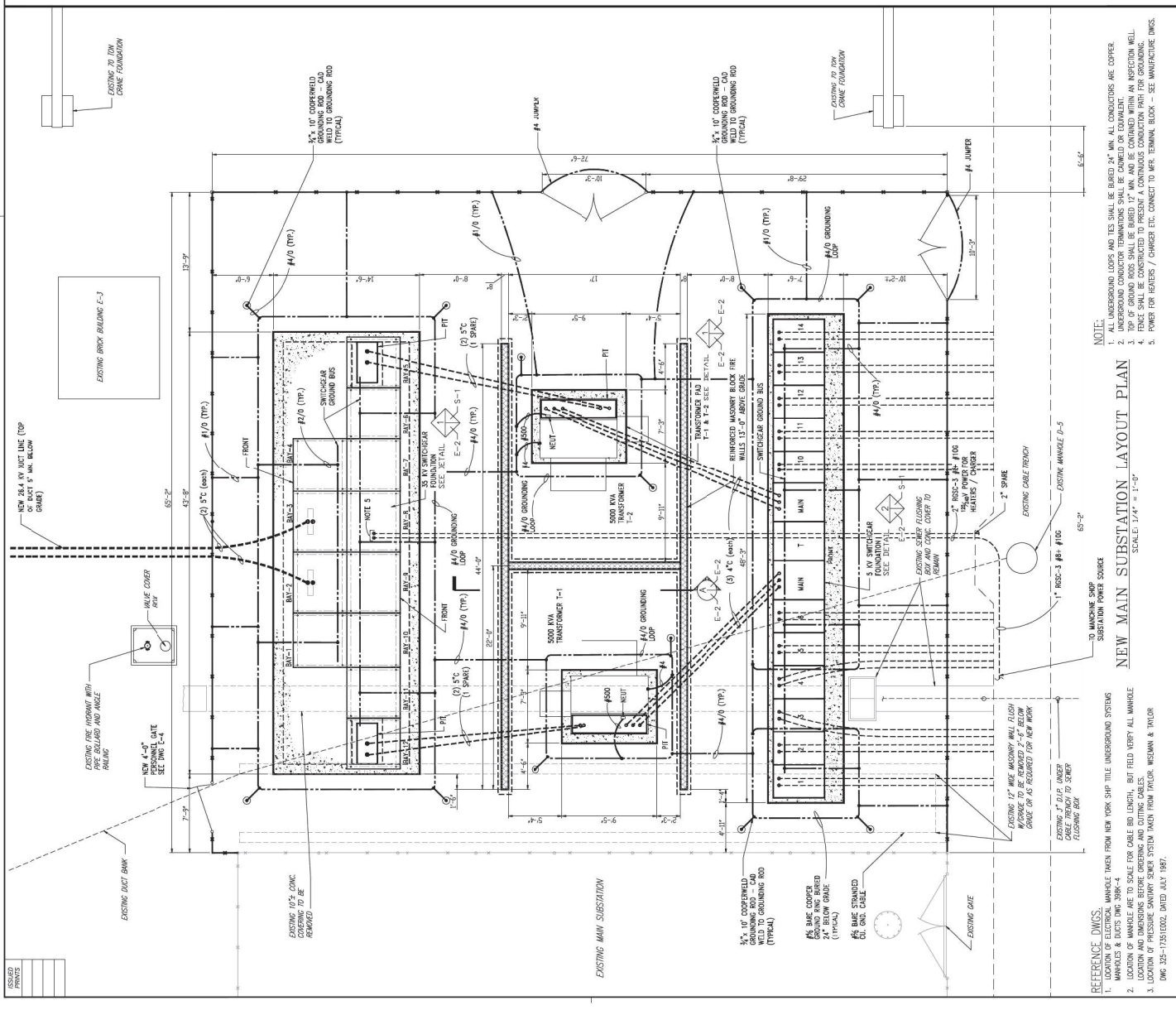

- NOTES:
- ALL UNDERGROUND LINES AND TIES SHALL BE BURIED 24" MIN. ALL CONDUCTORS ARE COPPER.
 - UNDERGROUND CONDUCTOR TERMINATIONS SHALL BE CAPPED OR EQUIPPED.
 - TOP OF GROUND RODS SHALL BE BURIED 12" MIN. AND BE CONTAINED WITHIN AN INSPECTION WELL.
 - FENCE SHALL BE CONSTRUCTED TO PRESENT A CONTINUOUS CONDUCTION PATH FOR GROUNDING.
 - POWER FOR HEAVIES / CHARGER ETC. CONNECT TO MFR. TERMINAL BLOCK - SEE MANUFACTURE DIMS.

NEW MAIN SUBSTATION LAYOUT PLAN
SCALE: 1/4" = 1'-0"

- REFERENCE DIMS.
- LOCATION OF ELECTRICAL MANHOLE TAKEN FROM NEW YORK SHIP TITLE UNDERGROUND SYSTEMS MANHOLES & DUCTS DMC 39K-4
 - LOCATION OF MANHOLE ARE TO SCALE FOR CABLE BD LENGTH, BUT FIELD VERIFY ALL MANHOLE LOCATION AND DIMENSIONS BEFORE ORDERING AND CUTTING DANGLES.
 - FIELD VERIFY ALL DIMS FROM PHOTO, WILKINSON & PAXOR DMS 326-13810302, DATED JULY 1987.

ISSUED PRINTS	
DATE	
BY	
FOR	

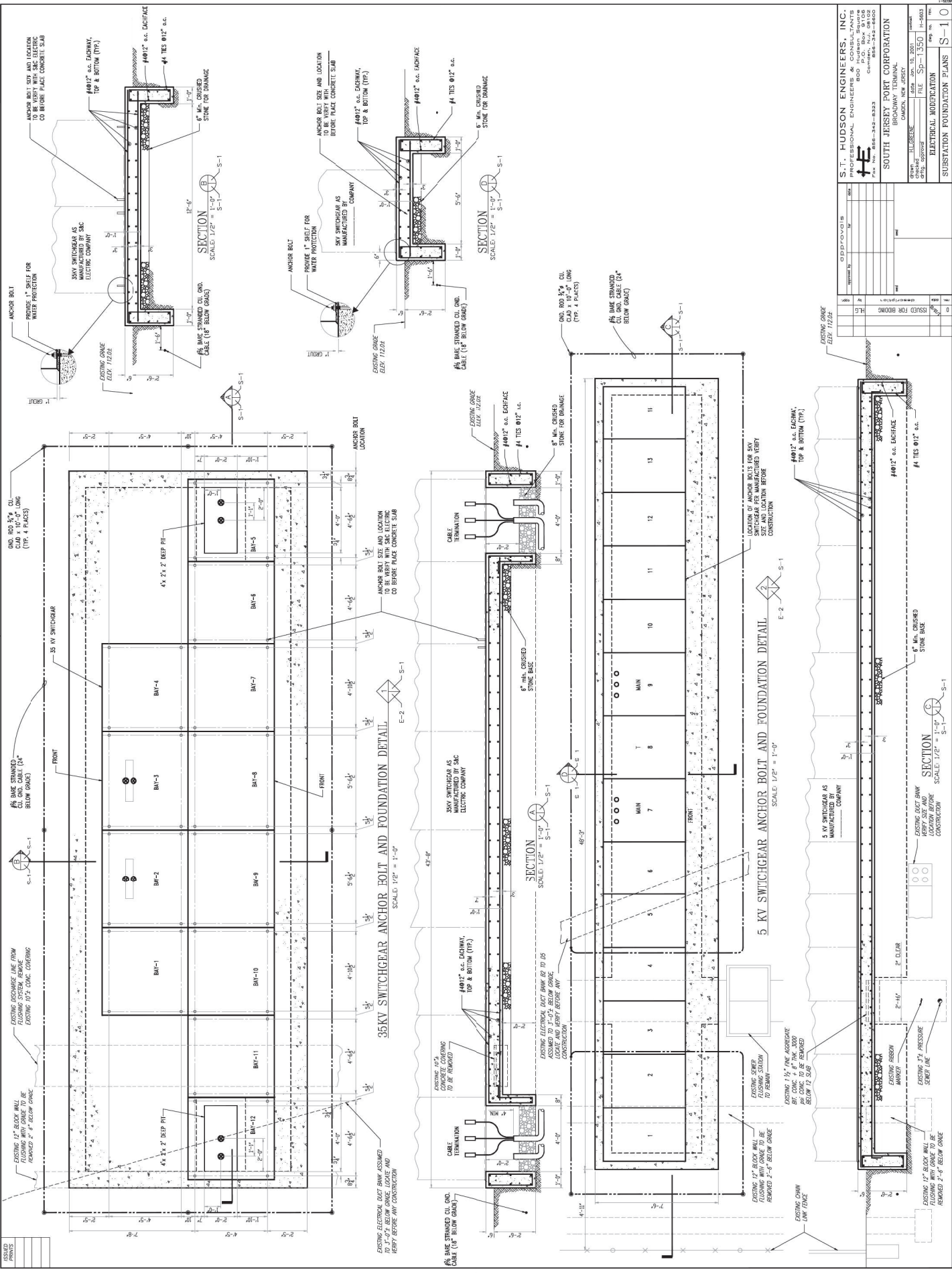

APPROVALS		DATE	
DESIGNED BY	DATE	CHECKED BY	DATE
DRAWN BY	DATE	ISSUED FOR BIDDING	DATE
PROJECT NO.	DATE	PROJECT NO.	DATE
FILE NO.	DATE	FILE NO.	DATE

S.T. HUDSON ENGINEERS, INC.
 PROFESSIONAL ENGINEERS
 800 Hudson Square
 Newark, NJ 07102
 Tel: 973-262-8822
 Fax: 973-262-8823
 NJ REG. NO. 24-262-0001
 NJ REG. NO. 24-262-0002

SOUTH JERSEY PORT CORPORATION
 1000 ROUTE 138
 SOUTH JERSEY CITY, NJ 07080

ELECTRICAL MODIFICATION
 SUBSTATION FOUNDATION PLANS
 SHEET NO. S-10

NO.	REVISION	DATE
1	ISSUED FOR BIDDING	11/14/2003
2	ISSUED FOR BIDDING	11/14/2003
3	ISSUED FOR BIDDING	11/14/2003

SECTION S-1
SCALE: 1/2" = 1'-0"

SECTION S-2
SCALE: 1/2" = 1'-0"

SECTION S-3
SCALE: 1/2" = 1'-0"

SECTION S-4
SCALE: 1/2" = 1'-0"

SECTION S-5
SCALE: 1/2" = 1'-0"

SECTION S-6
SCALE: 1/2" = 1'-0"

SECTION S-7
SCALE: 1/2" = 1'-0"

SECTION S-8
SCALE: 1/2" = 1'-0"

SECTION S-9
SCALE: 1/2" = 1'-0"

SECTION S-10
SCALE: 1/2" = 1'-0"

SECTION S-11
SCALE: 1/2" = 1'-0"

SECTION S-12
SCALE: 1/2" = 1'-0"

SECTION S-13
SCALE: 1/2" = 1'-0"

SECTION S-14
SCALE: 1/2" = 1'-0"

SECTION S-15
SCALE: 1/2" = 1'-0"

SECTION S-16
SCALE: 1/2" = 1'-0"

SECTION S-17
SCALE: 1/2" = 1'-0"

SECTION S-18
SCALE: 1/2" = 1'-0"

SECTION S-19
SCALE: 1/2" = 1'-0"

SECTION S-20
SCALE: 1/2" = 1'-0"

SECTION S-21
SCALE: 1/2" = 1'-0"

SECTION S-22
SCALE: 1/2" = 1'-0"

SECTION S-23
SCALE: 1/2" = 1'-0"

SECTION S-24
SCALE: 1/2" = 1'-0"

SECTION S-25
SCALE: 1/2" = 1'-0"

SECTION S-26
SCALE: 1/2" = 1'-0"

SECTION S-27
SCALE: 1/2" = 1'-0"

SECTION S-28
SCALE: 1/2" = 1'-0"

SECTION S-29
SCALE: 1/2" = 1'-0"

SECTION S-30
SCALE: 1/2" = 1'-0"

SECTION S-31
SCALE: 1/2" = 1'-0"

SECTION S-32
SCALE: 1/2" = 1'-0"

SECTION S-33
SCALE: 1/2" = 1'-0"

SECTION S-34
SCALE: 1/2" = 1'-0"

SECTION S-35
SCALE: 1/2" = 1'-0"

SECTION S-36
SCALE: 1/2" = 1'-0"

SECTION S-37
SCALE: 1/2" = 1'-0"

SECTION S-38
SCALE: 1/2" = 1'-0"

SECTION S-39
SCALE: 1/2" = 1'-0"

SECTION S-40
SCALE: 1/2" = 1'-0"

SECTION S-41
SCALE: 1/2" = 1'-0"

SECTION S-42
SCALE: 1/2" = 1'-0"

SECTION S-43
SCALE: 1/2" = 1'-0"

SECTION S-44
SCALE: 1/2" = 1'-0"

SECTION S-45
SCALE: 1/2" = 1'-0"

SECTION S-46
SCALE: 1/2" = 1'-0"

SECTION S-47
SCALE: 1/2" = 1'-0"

SECTION S-48
SCALE: 1/2" = 1'-0"

SECTION S-49
SCALE: 1/2" = 1'-0"

SECTION S-50
SCALE: 1/2" = 1'-0"

SECTION S-51
SCALE: 1/2" = 1'-0"

SECTION S-52
SCALE: 1/2" = 1'-0"

SECTION S-53
SCALE: 1/2" = 1'-0"

SECTION S-54
SCALE: 1/2" = 1'-0"

SECTION S-55
SCALE: 1/2" = 1'-0"

SECTION S-56
SCALE: 1/2" = 1'-0"

SECTION S-57
SCALE: 1/2" = 1'-0"

SECTION S-58
SCALE: 1/2" = 1'-0"

SECTION S-59
SCALE: 1/2" = 1'-0"

SECTION S-60
SCALE: 1/2" = 1'-0"

SECTION S-61
SCALE: 1/2" = 1'-0"

SECTION S-62
SCALE: 1/2" = 1'-0"

SECTION S-63
SCALE: 1/2" = 1'-0"

SECTION S-64
SCALE: 1/2" = 1'-0"

SECTION S-65
SCALE: 1/2" = 1'-0"

SECTION S-66
SCALE: 1/2" = 1'-0"

SECTION S-67
SCALE: 1/2" = 1'-0"

SECTION S-68
SCALE: 1/2" = 1'-0"

SECTION S-69
SCALE: 1/2" = 1'-0"

SECTION S-70
SCALE: 1/2" = 1'-0"

SECTION S-71
SCALE: 1/2" = 1'-0"

SECTION S-72
SCALE: 1/2" = 1'-0"

SECTION S-73
SCALE: 1/2" = 1'-0"

SECTION S-74
SCALE: 1/2" = 1'-0"

SECTION S-75
SCALE: 1/2" = 1'-0"

SECTION S-76
SCALE: 1/2" = 1'-0"

SECTION S-77
SCALE: 1/2" = 1'-0"

SECTION S-78
SCALE: 1/2" = 1'-0"

SECTION S-79
SCALE: 1/2" = 1'-0"

SECTION S-80
SCALE: 1/2" = 1'-0"

SECTION S-81
SCALE: 1/2" = 1'-0"

SECTION S-82
SCALE: 1/2" = 1'-0"

SECTION S-83
SCALE: 1/2" = 1'-0"

SECTION S-84
SCALE: 1/2" = 1'-0"

SECTION S-85
SCALE: 1/2" = 1'-0"

SECTION S-86
SCALE: 1/2" = 1'-0"

SECTION S-87
SCALE: 1/2" = 1'-0"

SECTION S-88
SCALE: 1/2" = 1'-0"

SECTION S-89
SCALE: 1/2" = 1'-0"

SECTION S-90
SCALE: 1/2" = 1'-0"

SECTION S-91
SCALE: 1/2" = 1'-0"

SECTION S-92
SCALE: 1/2" = 1'-0"

SECTION S-93
SCALE: 1/2" = 1'-0"

SECTION S-94
SCALE: 1/2" = 1'-0"

SECTION S-95
SCALE: 1/2" = 1'-0"

SECTION S-96
SCALE: 1/2" = 1'-0"

SECTION S-97
SCALE: 1/2" = 1'-0"

SECTION S-98
SCALE: 1/2" = 1'-0"

SECTION S-99
SCALE: 1/2" = 1'-0"

SECTION S-100
SCALE: 1/2" = 1'-0"

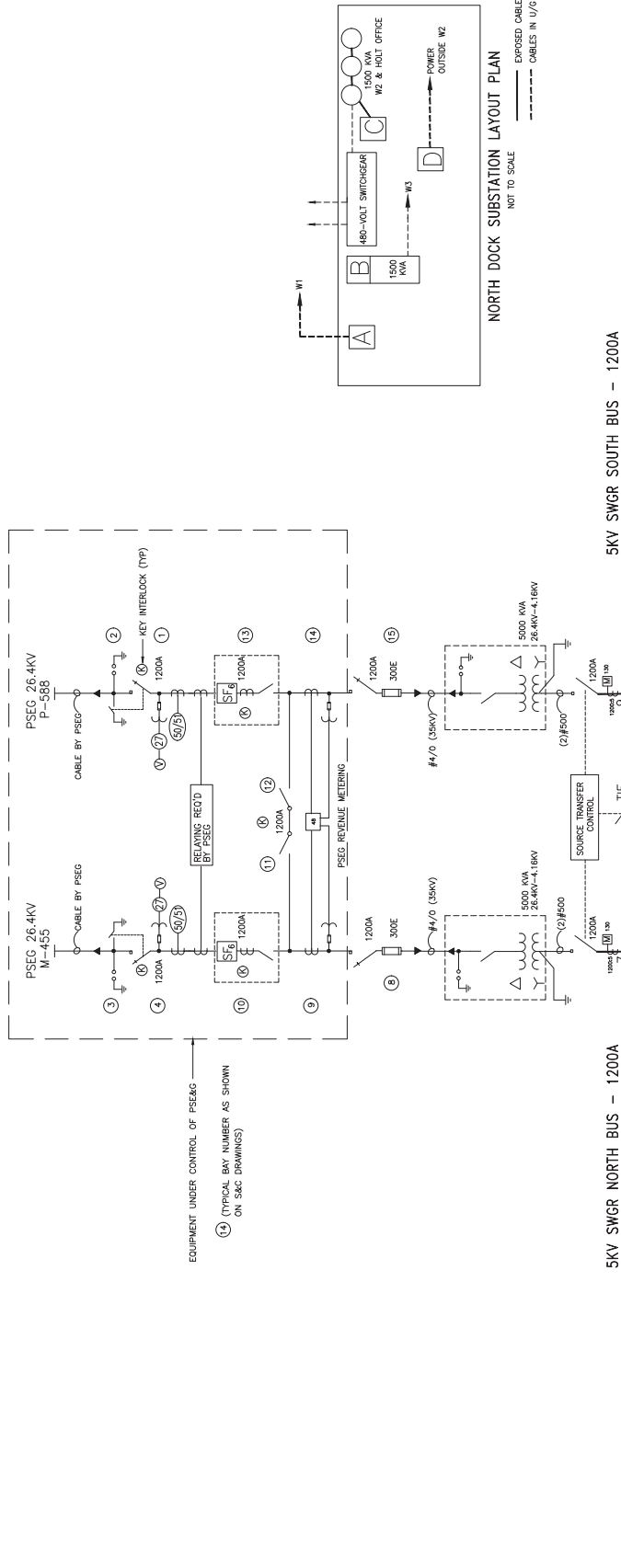

EQUIPMENT UNDER CONTROL OF PSE&G
 (4) (TYPICAL BAY NUMBER AS SHOWN ON SAC DRAWINGS)

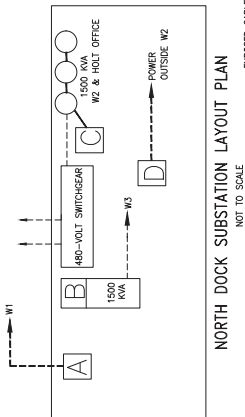

- REV 6/15/2023 MAIN SUB FORKLIFT CHARGERS
- REV 4/27/2023 UPDATED LABELING
- REV 4/11/05 UPDATED FOR NEW PUMP STATION
- REV 4/21/06 FOR JOSEPH OAT CO. EXPANSION
- REV 4/2/07 FOR CAMDEN YARDS NEW SHEAR LINE
- REV 9/23/09 FOR SUB. 'D' XFMR REPLACEMENT
- REV 12/27/16 FOR HOLT MODIFICATIONS
- REV 3/29/17 FOR HOLT MODIFICATIONS
- REV 1/20/21 CLARIFICATIONS IN NORTH DOCK SUB

PUMP STATION EQUIPMENT ADDED IN 2004 BY OTHERS AND WIRE SIZES ETC ARE ASSUMED

NOTATION

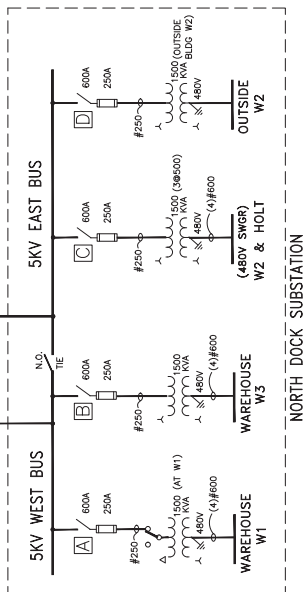

**SJPC BROADWAY TERMINAL
 OVERALL ONE-LINE DIAGRAM**