



REQUEST FOR SEALED BID PROPOSALS

SJPC 24-E7

BUILDING B SANITARY PUMP STATION REPAIRS

AT THE

BALZANO MARINE TERMINAL

SOUTH JERSEY PORT CORPORATION

2 Aquarium Drive, Suite 100

Camden, NJ 08103

Proposal Due Date:

Tuesday, August 20, 2024

SJPC-24-E7
REQUEST FOR SEALED BIDS
BUILDING B SANITARY PUMP STATION REPAIRS
AT THE BALZANO MARINE TERMINAL

OVERVIEW

The South Jersey Port Corporation (“SJPC”) is an agency and instrumentality of the State of New Jersey with a mission to develop, maintain and operate marine terminals and related intermodal transportation infrastructure within the South Jersey Port District. The agency has primary offices at 2 Aquarium Drive, Suite 100, Camden, New Jersey 08103, and port operations at the Balzano Marine Terminal and the Broadway Terminal, both located on the Delaware River in Camden, New Jersey. The agency also has facilities in Salem and Paulsboro. SJPC is grantee of Foreign Trade Zone #142.

Additional information may be found by visiting <http://www.southjerseyport.com>

ADVERTISEMENT FOR BIDS:

SOUTH JERSEY PORT CORPORATION
REQUEST FOR SEALED BIDS FOR
BUILDING B SANITARY PUMP STATION REPAIRS AT THE BALZANO MARINE TERMINAL

Notice is hereby given that sealed bids for **BUILDING B SANITARY PUMP STATION REPAIRS AT THE BALZANO MARINE TERMINAL**, will be received by the SJPC. Four (4) original sealed copies of each firm’s bid shall be submitted to Alvin Cooley, Senior Purchasing Agent, at the SJPC offices located in the Ferry Terminal Building, 2 Aquarium Drive, Suite 100, Camden, NJ 08103, by **Tuesday, August 20, 2024 at 11:00 AM ET**, at which time the sealed bids will be opened and recorded.

A Pre-Bid meeting will be held at the Balzano Marine Terminal, 101 Balzano Boulevard, Camden, NJ, meeting at the main gate, on **Tuesday, August 6, 2024 at 11:00 am**. Attendance at this meeting is not mandatory but is strongly recommended. Participants planning to attend the Pre-Bid Meeting must notify in advance Alvin Cooley, Senior Purchasing Agent, via e-mail at acooley@southjerseyport.com.

Each submission to be considered shall comport to the criteria set forth in the bid packets. The bid packets may be obtained from SJPC at <http://www.southjerseyport.com>, or upon request to: South Jersey Port Corporation, Attention: Alvin Cooley, Senior Purchasing Agent, 2 Aquarium Drive, Suite 100, Camden, NJ 08103, acooley@southjerseyport.com.

Bidders are required to comply with the requirements of N.J.S.A. 10:5-31, et seq. and N.J.A.C. 17:27, et seq.

INFORMATION FOR BIDDERS:

SJPC-24-E7 BUILDING B SANITARY PUMP STATION REPAIRS AT THE BALZANO MARINE TERMINAL

Sealed Bid Proposals shall be received in accordance with the public advertisement as required by law, a copy of said notice being attached hereto, and made part of these specifications.

Project Site Pre-Bid Meeting

A recommended project on-site review and walk down meeting for all bidders for this project will be held at Balzano Marine Terminal, 101 Balzano Boulevard, Camden, NJ, on **Tuesday, August 6, 2024 at 11:00 am**. Attendance is not mandatory but is strongly recommended. Failure to attend does not relieve the bidder of any obligations or requirements.

Submission of Proposals

In order to be considered, three (3) hard copies of the Bid Proposal, plus one USB drive containing a complete copy of the bid proposal in one PDF file, must be submitted in a sealed envelope bearing on the outside the name and address of the bidder, and the following statement:

“THIS IS A SEALED BID PROPOSAL AND SHALL NOT BE OPENED AND READ UNTIL **Tuesday, August 20, 2024 at 11:00 A.M.** BY ALVIN COOLEY, SENIOR PURCHASING AGENT AT THE SJPC, OR HIS DESIGNEE: SJPC-24–E7 BUILDING B SANITARY PUMP STATION REPAIRS AT THE BALZANO MARINE TERMINAL”.

Bid Proposals may be mailed or hand delivered to the SJPC, and shall be addressed to the attention of:

SOUTH JERSEY PORT CORPORATION
c/o Alvin Cooley, Senior Purchasing Agent
2 Aquarium Drive, Suite 100
Camden, New Jersey 08103

SJPC will not assume responsibility for Bid Proposals not delivered in person to the above address.

In addition to the three (3) required hard copies, bidders shall also submit an electronic version of your Bid Proposal in a pdf format on a USB drive.

All proposals must be received by **Tuesday, August 20, 2024 11:00 AM ET**. No proposal will be accepted after the specified time.

The sealed Bid Proposals will be opened and recorded at SJPC’s Offices located at 2 Aquarium Drive, Suite 100, Camden, NJ 08103. Once the sealed Bid Proposals have been opened, they shall remain firm for a period of ninety (90) calendar days.

All prices and amounts must be written in ink, or machine printed. Bid Proposals containing any conditions, omissions, unexplained erasures or alteration, items not called for in the Bid Proposal form, attachment of additive information not required by the specifications, or irregularities of any kind, may be rejected by SJPC. Any changes, white-outs, strikeouts, etc., in a Bid Proposal must be initialed in ink by the person signing the bid.

Each Bid Proposal form must give the full business address, business phone number, fax number, e-mail address, and contact person of the bidder, and must be signed by an authorized representative as follows:

- Bids by partnerships must furnish the full name of all partners and must be signed in the partnership name by one of the members of the partnership or by an authorized representative, followed by the signature and designation of the person signing.
- Bids by corporations must be signed in the legal name of the corporation, followed by the name of the State in which incorporated and must contain the signature and designation of the president, secretary or other person authorized to bind the corporation in the matter.
- Bids by sole-proprietorship shall be signed by the proprietor.
- When requested, satisfactory evidence of the authority of the officer signing shall be furnished.

Bidders should be aware of the following statutes that represent "Truth in Contracting" laws:

- N.J.S.A. 2C:21-34 et seq. governs false claims and representations by bidders. It is a serious crime for the bidder to knowingly submit a false claim and/or knowingly make a material misrepresentation.
- N.J.S.A. 2C:27-10 provides that a person commits a crime if said person offers a benefit to a public servant for an official act performed or to be performed by a public servant, which is a violation of official duty.
- N.J.S.A. 2C:27-11 provides that a bidder commits a crime if said person, directly or indirectly, confers or agrees to confer any benefit allowed by law to a public servant.
- Bidders should consult the statutes or legal counsel for further information.

Bidders are expected to examine the bid specifications and related bid documents with care and observe all their requirements. Ambiguities, errors, or omissions noted by bidders should be promptly reported in writing to SJPC's Senior Purchasing Agent, Alvin Cooley, via email, at acooley@southjerseyport.com. Any prospective bidder who wishes to challenge a bid specification shall file such challenge in writing with SJPC no less than three (3) business days prior to the opening of the bids. Challenges filed after that time shall not be considered and have no impact on SJPC or the award of the contract. In the event the bidder fails to notify SJPC of such ambiguities, errors, or omissions, the bidder shall be bound by the requirements of the specifications and the bidder's submitted bid.

No oral interpretation and or clarification of the meaning of the specifications will be made to any bidder. Questions regarding this Request for Sealed Bid Proposals may be directed in writing to Alvin Cooley, Senior Purchasing Agent, at acooley@southjerseyport.com. No questions will be answered if not submitted by the deadline for questions, **Monday, August 12, 2024, at 5:00 PM.**

Reservations

The SJPC reserves the right to reject any or all Bid Proposals, to waive irregularities and technicalities, to request re-submissions, and to award a contract, as the SJPC deems will best serve the interests of the SJPC.

The SJPC, nor its respective staff, consultants, or advisors shall be liable for any claims or damages resulting from the solicitation or preparation of the Bid Proposals, nor will there be any reimbursement to any bidders for the cost of preparing and submitting a Bid Proposal, nor for participating in this process.

During the period provided for the preparation of responses to the Request for Sealed Bid Proposals, the SJPC may issue addenda, amendments, or answers to written inquiries. When issuing addenda, SJPC shall provide required notice prior to the official receipt of bids to any person who has submitted a bid, or who has received a bid package, and all issued addenda will constitute a part of the Request for Sealed Bid Proposals. All responses shall be prepared with full consideration of the addenda issued prior to the bid proposal submission date.

The SJPC will consider bids only from firms or organizations that have demonstrated the capability and willingness to provide high quality services in the manner described herein.

A final decision will be made only after all bids have been received, evaluated, and presented to the SJPC Board of Directors for consideration. The SJPC's evaluation process is designed to identify the bidder that provides the most advantageous solution to the SJPC by including an evaluation of each vendor's technical capabilities, past performance, and overall cost of the proposal to the SJPC.

SJPC reserves the right to make any and all decisions regarding the selection of the successful bidder, and to waive any formality, and to take any action that the SJPC determines in its sole discretion to be in the best interest of the SJPC. The provisions of this bid package are made for the benefit of the SJPC, and no right shall be deemed to accrue to any person submitting a bid, statement of qualifications, or Bid Proposal by reason of the submission of any bid, statement of qualifications, or Bid Proposal, or by the waiver or non-enforcement of any provisions or requirements contained within this bid package, or by reason of any term or terms thereof.

BID REQUIREMENTS

BID SECURITY

The form of bid security shall be a BID BOND to accompany the Bid Proposal in the amount of 10% of the total bid price, but not in excess of \$20,000, payable unconditionally to SJPC. It shall contain a Power of Attorney for the full amount of the Bid Bond from a surety company (see below). The Bid Bond of an unsuccessful bidder shall be returned in the same manner as set out in N.J.S.A. 40A:11-24a. The Bid Bond of the bidder to whom the contract is awarded shall be retained until a contract is executed, and the required Performance Bond is submitted. The Bid Bond of the successful bidder shall be forfeited if the bidder fails to enter a contract.

*Failure to submit bid security shall result in rejection of the Bid Proposal.

PERFORMANCE BOND

Each Bid Proposal shall also be accompanied by a letter of intent from the bidder's Bonding Company confirming that, if the bidder is awarded the contract, the Bonding Company will furnish the required PERFORMANCE BOND EQUAL TO THE BID PRICE as security for the faithful performance of the contract. The performance bond shall not be released until final acceptance of the whole work, and then only if any liens or claims have been satisfied.

Each Surety submitted must be with a company that is rated at least A- or better with AM Best, authorized to do business in the State of New Jersey, and proof of same must accompany the bid.

LETTER OF TRANSMITTAL

SJPC requests that along with the Bid Proposal, the bidder enclose a letter of transmittal, which is not intended to be a summary of the bid itself, but must contain the following statements and information:

1. General Information

- a. Company name, address, and telephone number(s) of the bidder submitting the proposal.
- b. Name, title, address, e-mail address, and telephone number of the person or persons to contact who are authorized to represent the bidder, and to whom correspondence should be directed.
- c. Federal and state taxpayer identification numbers of the bidder.
- d. Brief statement of the bidder's understanding of the services to be performed, and a positive commitment to provide the services as specified.

e. The letter must be signed by a corporate officer or other individual of the bidder who is legally authorized to bind the bidder to both its Bid Proposal and cost schedule.

f. General bidder information- Please provide the following information:

i. Length of time in business of providing proposed services.

ii. List 3 other public sector clients.

iii. Number of full-time personnel in the organization.

iv. Location of headquarters and field offices.

v. Location of office which would service this account.

2. Describe how the bidder is positioned to provide the services request in the bid package, e and provide a history of experience on providing similar services.

3. Describe the bidder's approach to providing these services and its methodology for providing ongoing support.

4. Provide the name, title, address and telephone number of three references for clients whom the bidder has provided similar services. Please provide information referencing the actual services provided, customer size (number of users), and the length of tenure providing services to this client.

5. Staff Resources – Identify names of principals and key personnel who will perform the services.

REQUIRED INSURANCE ACKNOWLEDGEMENT

The bidder shall complete the Required Insurance Acknowledgement and provide a Certificate of Insurance for coverage consistent with the section "Insurance Requirements", or a letter from their insurance company stating their ability to provide a Certificate of Insurance if awarded the contract.

BID FORM

Bid Form must be complete, with all appropriate signatures and acknowledgement of addenda.

SUBCONTRACTOR DECLARATION

The bidder shall complete a Subcontractor Declaration and submit with their bid, a description of contract work they will not be performing with their organization, if any, as outlined in the Subcontractor Declaration.

WARRANTY

Bidder shall provide a warranty covering equipment, material, and workmanship for a minimum of one (1) year, starting from completion and final acceptance of the contract work to be performed.

ACCESS TO TERMINALS – TWIC REQUIREMENT

In accordance with the Maritime Transportation Security Act, all persons requiring unescorted access to restricted SJPC facilities must possess a Transportation Worker Identification Credential (TWIC) issued by the Transportation Security Administration before such access is granted. Persons seeking access to SJPC facilities who do not physically possess a TWIC may only enter SJPC facilities with an SJPC approved TWIC escort as a side-by-side companion.

ADDITIONAL APPLICANT RESPONSIBILITIES

The bidder shall, in response to the SJPC's Request for Sealed Bid Proposals, also include the following documents, which are all available at www.southjerseyport.com/bids:

1. Small Business Enterprise Questionnaire. The bidder shall submit a completed form (Exhibit Q1).
2. Mandatory Equal Opportunity. The bidder shall submit a completed form (Exhibit Q2 or Q3, whichever is applicable).
3. Stockholder Disclosure Certificate. The bidder shall submit a completed form (Exhibit Q4).
4. Non-Collusion Affidavit. The bidder shall submit a completed form (Exhibit Q5).
5. Debarred List Affidavit. The bidder shall submit a completed form (Exhibit Q6).
6. Affirmative Action Evidence for Procurement. The bidder shall submit a completed form (Exhibit Q7).
7. Business Registration Certificate. The bidder shall submit a completed form (Exhibit Q8).
8. Set-Off State Tax. The bidder shall submit a completed form (Exhibit Q9).
9. Intentionally omitted (Exhibit Q10).
10. Source Disclosure Form. The bidder shall submit a completed form (exhibit Q11).
11. Executive Order #189 Vendor Code of Ethics Affidavit. The bidder shall submit a completed form (Exhibit Q12).

12. Executive Order #117 Two Year Chapter 51/ Vendor Certification and Disclosure of Political Contributions. The bidder shall submit a completed form (Exhibit Q13).
13. Executive Order #151 Contract Compliance. The bidder complete and submit form AA302 (Exhibit Q14).
14. Employee Information Report. The bidder shall submit a completed form AA302 (Exhibit Q15).
15. Ownership Disclosure Form. The bidder shall submit a completed form (Exhibit Q16).
16. Prevailing Wage Notification. The bidder shall submit a completed form (Exhibit Q17).
17. Public Workers Contract Registration. The bidder shall submit a completed form (Exhibit Q18).
18. Buy American Notice. In the performance of the work under this contract, the bidder and all its subcontractors shall use only domestic materials. (Exhibit Q19).
19. Executive Order #117 Pay-to-Play Restrictions. The bidder shall submit a completed form (Exhibit Q20).
20. Disclosure/Certification of Investment Activities in Iran. The bidder shall submit a completed form (Exhibit Q21).
21. NJ ELEC Affidavit. The bidder shall submit a completed form (Exhibit Q22).
22. Intentionally omitted (Exhibit Q23).
23. Intentionally omitted. (Not required). (Exhibit Q24).
24. Diane Allen Act Acknowledgement. The bidder shall submit a completed form (Exhibit Q25).
25. Assurances for Payment of Prevailing Wage. The bidder shall submit a completed form, if applicable. (Exhibit Q26).
26. Confidentiality and Commitment to Defend. The bidder shall submit a completed form, if applicable. (Exhibit Q27).
27. Disclosure of Investigations and Other Actions Involving the Vendor Form. The bidder shall submit a completed form, if applicable. (Exhibit Q28).
28. Macbride Principles Form. The bidder shall submit a completed form, if applicable. (Exhibit Q29).

INSURANCE REQUIREMENTS

PROFESSIONAL and/or CONTRACTOR SERVICES CONTRACTS

Prior to the commencement of any work and until completion and final payment is made for the work / final acceptance of the work, the successful bidder will provide and maintain the following minimum levels of insurance at bidder's own expense. The cost of the required insurance shall be included in the bidder's bid price and no adjustment shall be made to the contract price on account of such costs unless such approval is provided. The term bidder shall include any Subcontractors and Sub-Subcontractors of every tier proposed to be used by the bidder to complete the work. Bidder shall furnish Certificates of Insurance evidencing and reflecting the effective date of coverage as outlined below. In no event shall Work be performed until the required evidence of Insurance is provided in accordance with the requirements of this Bid Proposal, and any Contract Documents, and is approved by SJPC. If found to be non-compliant, SJPC may purchase the required insurance coverage(s) and the cost will be borne by the successful bidder receiving a contract through direct payment/reimbursement to SJPC, or SJPC may withhold payment to the said bidder for amounts owed to them.

- a) All insurance shall be procured from insurers permitted to do business in the State in which the project is taking place and have an A.M. Best Rating of at least "A-, Class VIII".
- b) Bidder shall not have a Self-Insured Retention (SIR) on any policy greater than \$50,000, which is the responsibility of the Contractor. If bidder's policy (-ies) has a Self-Insured Retention exceeding this amount, approval must be received from SJPC prior to starting work. In the event any policy includes an SIR, the bidder is solely responsible for payment within the SIR of their policy (-ies) and the Additional Insured requirements specified herein shall be provided within the SIR amount(s).
- c) All insurance required herein, with the exception of the Professional Liability Insurance, shall be written on an "occurrence" basis. Claims-Made coverage must include:
 - i. The retroactive date must be on or prior to the start of work under the contract; and
 - ii. The successful bidder must purchase "tail coverage/an extended reporting period" or maintain coverage for a period of three years, subsequent to the completion of their work / final payment.
- d) The successful bidder's insurance carrier(s) shall agree to provide at least thirty (30) days prior written notice to SJPC in the event coverage is canceled or non-renewed and ten (10) days in the event of cancellation for non-payment of premium. In the event of cancellation or non-renewal of coverage(s), it is the said bidder's responsibility to replace coverage to comply with the contract requirements so there is no lapse of coverage for any time period.

In the event the insurance carriers will not issue or endorse their policy(s) to comply with the above it is the responsibility of the successful bidder to report any notice of cancellation or non-renewal at least thirty (30) days prior to the effective date of this notice.

- e) Successful bidder shall provide SJPC with Certificates of Insurance, evidencing the insurance coverages listed below, ten days prior to the start of work and thereafter upon renewal or replacement of each coverage. The successful bidder shall not begin any work until SJPC has reviewed and approved the Certificate of Insurance. The required insurance shall not contain any exclusions or endorsements, which are not acceptable to SJPC.

Failure of SJPC to demand such certificate or other evidence of full compliance with these insurance requirements or failure of SJPC to identify a deficiency from evidence that is provided shall not be construed as a waiver of Contractor's obligation to maintain such insurance.

With respect to insurance maintained after final payment in compliance with a requirement below, an additional certificate(s) evidencing such coverage shall be provided to SJPC with final application for payment and thereafter upon renewal or replacement of such insurance until the expiration of the time period for which such insurance must be maintained.

- f) SJPC shall be added as ADDITIONAL INSURED on all liability policies (except Workers' Compensation and Professional Liability Policy, where applicable), for ongoing operations and completed operations (using ISO Endorsements CG 2010 and CG 2037, or their equivalents) on a primary noncontributory basis. Coverage to include ongoing and completed operations. Each of the Additional Insured's respective officials, employees, agents and representatives shall also be afforded coverage as an Additional Insured. Coverage should be provided for a period of three years subsequent to the completion of work/final payment.

SJPC reserves the right to require Contractor to name other parties as additional insureds as required by SJPC.

There shall be no "Insured versus Insured Exclusion" on any policies (other than "Named Insured versus Named Insured"); all policies will provide for "cross liability coverage" as per standard ISO policy forms.

- g) Waiver of Rights of Subrogation: With the exception of Professional Liability, the successful bidder shall waive all rights of recovery against Owner/Client, SJPC, and all the additional insureds for loss or damage covered by any of the insurance maintained by the successful bidder.

- h) The amount of insurance provided in the required insurance coverages, shall not be construed to be a limitation of the liability on the part of the successful bidder.
- i) The carrying of insurance described shall in no way be interpreted as relieving the successful bidder of any responsibility or liability under the contract.
- j) Any type of insurance or any increase in limits of liability not described above which the successful bidder requires for its own protection, or on account of statute, shall be at its own expense.
- k) Successful bidder shall promptly notify SJPC and the appropriate insurance company (-ies) in writing of any accident(s) as well as any claim, suit or process received by the Contractor arising in the course of operations under the contract. The successful bidder shall forward such documents received to his insurance company (-ies), as soon as practicable, or as required by their insurance policy (-ies).

REQUIRED COVERAGES - the following may be provided through a combination of primary and excess policies to meet the minimum limits set forth below:

Workers' Compensation and Employer's Liability:

Provided in the State in which the work is to be performed and elsewhere as may be required and shall include:

- a) Workers' Compensation Coverage: Statutory Requirements
- b) Employers Liability Limits not less than:

Bodily Injury by Accident:	\$500,000 Each Accident
Bodily Injury by Disease:	\$500,000 Each Employee
Bodily Injury by Disease:	\$500,000 Policy Limit
- c) Jones Act/Maritime Liability and USL&H Coverage, as applicable.
- d) Includes coverage for sole proprietors, partners, members or officers who will be performing the work.

Commercial General Liability:

Provided on ISO form CG 00 01 04 13 or an equivalent form including Premises - Operations, Independent Contractors, Products/Completed Operations, Broad Form Property Damage, Contractual Liability, and Personal Injury and Advertising Injury.

- a) Occurrence Form with the following limits:

(1) General Aggregate:	\$2,000,000
(2) Products/Completed Operations Aggregate:	\$2,000,000
(3) Each Occurrence:	\$1,000,000

- (4) Personal and Advertising Injury: \$1,000,000
- b) Products/Completed Operations Coverage must be maintained for a period of at least three (3) years after final payment / completion of work (including coverage for the Additional Insureds as set forth in these Insurance Requirements).
- c) The General Aggregate Limit must apply on a **Per Project basis**.
- d) Coverage for "Resulting Damage".
- e) No sexual abuse or molestation exclusion.
- f) No exclusion for marine based work.
- g) No amendment to the definition of an "Insured Contract".
- h) The definition of an "Insured Contract" must be amended to provide coverage for all work on or within 50 feet of a railroad, if applicable. A stand-alone Railroad Protective Liability policy may be required based on the scope of this project.

Automobile Liability:

- a) Coverage to include All Owned, Hired and Non-Owned Vehicles (or "Any Auto"), if you do not have any Owned Vehicles you are still required to maintain coverage for Hired and Non-Owned Vehicles as either a stand alone policy or endorsed onto the Commercial General Liability policy above
- b) Per Accident Combined Single Limit \$1,000,000
- c) For Contractor(s) involved in the transportation of hazardous material, include the following endorsements: MCS-90 and ISO-9948.

Commercial Umbrella Liability:

- a) Policy(ies) to apply on a Following Form Basis of the following:
 - (1) Commercial General Liability,
 - (2) Automobile Liability, and
 - (3) Employers Liability Coverage.
- b) Minimum Limits of Liability

Occurrence Limit:	\$10,000,000
Aggregate Limit:	\$10,000,000

Watercraft Liability/Protection and Indemnity Liability:

- a) Provide coverage for bodily injury, property damage, personal and advertising injury arising out of any owned, leased, hired, or borrowed watercraft; and

- b) Minimum Limits of Liability:
 \$10,000,000 Per Occurrence
 \$10,000,000 Aggregate

Vessel Pollution Liability Insurance:

- a) Covering losses caused by pollution incidents that arise from the vessel(s) used in the operations of the successful bidder and /or their subcontractors of any tier.
- b) Minimum Limits of Liability:
 Occurrence Limit: \$10,000,000
 Aggregate Limit: \$10,000,000

Pollution Liability Insurance:

(IF DESIGNATED BY CONTRACTOR’S SCOPE OF WORK)

- c) Covering losses caused by pollution incidents that arise from the operations of the Contractor and /or their subcontractors of any tier.
- d) Minimum Limits of Liability:
 Occurrence Limit: \$10,000,000
 Aggregate Limit: \$10,000,000
- c) Insurance to be maintained for the duration of the work and for a period of three (3) years after completion of work / final payment.
- d) No Exclusions for Silica, Asbestos or Lead.
- e) Include Mold Coverage for full policy limit of liability.
- f) Shall include coverage for all pollutants as defined under the Resource Conservation and Recovery Act, as amended, 42 U.S.C. Section 6901 et. Seq. (“RCRA”) or any related state or city environmental statute or the removal of any petroleum contaminated material at the project.
- g) All owned and / or 3rd Party disposal facilities must be licensed and maintain pollution liability insurance of not less than \$2,000,000, if applicable.

Professional Liability Insurance:

(IF DESIGNATED BY CONTRACTOR’S SCOPE OF WORK)

- a) Minimum Limits of Liability

Per Claim Limit: \$10,000,000
Aggregate Limit: \$10,000,000

- b) The Definition of “Covered Services” shall include the services required in the scope of this contract.

Rigger’s Liability Insurance:

(IF DESIGNATED BY **CONTRACTOR’S SCOPE OF WORK**)

- a) “All Risk” Replacement Cost Coverage
- b) No overload exclusion
- c) Minimum Occurrence Limit: \$1,000,000

Aircraft Liability and/or Unmanned Aircraft Systems (UAS, aka Drones):

(IF DESIGNATED BY **CONTRACTOR’S SCOPE OF WORK**)

- a) Provide coverage for bodily injury, property damage, personal and advertising injury arising out of any owned, leased, hired, or borrowed aircraft or UAS; and
- b) Minimum Limits of Liability:
\$10,000,000 Per Occurrence
\$10,000,000 Aggregate

NOTE: If UAS are covered by the General Liability policy instead of an Aviation Policy, coverage must be provided by CG 24 50 (or its equivalent) for “any aircraft used in the Insured’s operations” for “any operations or projects of the Insured”.

Owner’s Contractor’s Protective:

(IF DESIGNATED BY **CONTRACTOR’S SCOPE OF WORK**)

- a) The successful bidder shall obtain an Owner’s and Contractor’s Protective in the same limits as set forth in #2, Commercial General Liability, above. This policy shall be issued in the name of the SJPC.
- b) If you are providing ongoing and completed operations Additional Insured coverage for one of the following states, noted in “f” above (Montana, New Mexico, Oregon, Colorado, Kansas, California, Louisiana, and Texas) you are required to provide an Owner’s Contractor’s Protective as outlined in the preceding paragraph.

Owned, Leased, Rented or Borrowed Equipment:

(IF DESIGNATED BY **CONTRACTOR'S SCOPE OF WORK**)

Successful bidder shall maintain Property Coverage for:

- a) their owned, leased, rented or borrowed equipment, tools, trailers, etc.; and
- b) include a Waiver of Subrogation in favor of all Additional Insureds.

Installation Floater:

(IF DESIGNATED BY **CONTRACTOR'S SCOPE OF WORK**)

- a) Successful bidder shall provide coverage for damage to property in the course of installation or transit to the installation site.
- b) Coverage shall be equal to the full replacement cost of the equipment or materials being installed. Coverage shall also be provided for any ensuing loss of Business or Rental Income.
- c) Successful bidder must determine if the Installation Floater policy, if in place for this project, is adequate to protect the interests of Owner.
- d) Include a Waiver of Subrogation in favor of all Additional Insureds.

Builders Risk

(IF DESIGNATED BY **CONTRACTOR'S SCOPE OF WORK**)

The successful bidder must place a Builder's Risk policy to protect their interest and the interests of the said bidder for the work to be completed. The successful bidder must determine if the Builders Risk policy is adequate to protect the interests of the SJPC and all of the Additional Insureds listed above. The following are the requirements to be provided under the policy that the Port elects to place:

- a) Full Replacement Cost Coverage
- b) Permission to Occupy will be granted
- c) All Risk Coverage
- d) Business Income and Extra Expense

The Builder's Risk Policy will include the SJPC, as well as all other parties where required by written contract.

A Waiver of Subrogation will be provided in favor of the following even if their negligence causes the loss and regardless of the extent of their insurable interest in the covered property: the Port, Contractor, Subcontractor, Sub-Subcontractors and all other parties where required by written contract.

INDEMNIFICATION

The successful bidder will protect, defend, indemnify and hold harmless the SJPC, including its respective officials, employees, agents and representatives from and against any and all losses, penalties, damages, settlements, costs, charges, professional fees or other expenses or liabilities arising out of or resulting from the performance of the work or the completed operations provided that any such claims, damage, loss or expense is attributable to bodily injury, sickness, disease, or death, or to injury to or destruction of the tangible property including the loss of the use resulting there from; and is caused in whole or in part by any negligent or willful act or omission of the successful bidder, and any of its contractors, subcontractor(s), sub-subcontractor(s), and anyone directly or indirectly employed by any of them or anyone for whose acts any of them may be liable.

In any and all claims against the SJPC or any of their respective officials, employees, agents and representatives, by an employee of the successful bidder, and any of its, contractors, subcontractor(s), or any Sub-subcontractor(s), or anyone directly or indirectly employed by any of them, or anyone for whose acts any of them may be liable, the indemnification obligation shall not be limited in any way by any limitation on the amount or type of damages, compensation or benefits payable by or for the successful bidder, or any of its contractors, subcontractor(s) or sub-subcontractor(s) under Workmen's Compensation Acts, Disability Benefits Acts, or other employee benefits programs.

These Indemnification provisions shall survive the termination of any Contract entered into between the successful bidder and the SJPC.

RESPONSIBILITY OF BIDDERS

EXAMINATION OF PROJECT SITE, BID REQUIREMENTS

Bidders should become thoroughly aware of the conditions under which the work will be performed. A Pre-Bid Meeting will be held to orient potential bidders to the project site. Attendance at the Pre-Bid meeting is strongly recommended, but not mandatory.

Questions raised by bidders shall be in writing and will only be officially answered by the issuance of addenda by SJPC to all bidders. Only such addenda will be considered part of the Contract Documents.

Bidders must carefully examine, for themselves, the plans, detailed drawings, specifications, estimated quantities, the location of the proposed work, if applicable, and this entire bid package. They shall exercise their own judgement as to the full scope and nature of the work, the difficulties to be encountered and the accuracy of estimated quantities, when given. Each bidder will be held fully responsible for having complied with, and thoroughly understood the entire bid package prior to

submitting their bid; and shall not, at any time, thereafter complain of such estimates, nor assert that there was any misunderstanding in regard to the nature or amount of work to be done.

At the time of the opening of bids, each bidder will be presumed to have inspected the site, and to have read, and to be thoroughly familiar with the entire bid package, including, but not limited to, all plans, specifications contract documents, and all addenda. The failure or omission of any bidder to receive or examine any form, instrument, or document, shall in no way relieve the bidder from any obligations in respect to their bid.

QUALIFICATIONS OF BIDDERS

SJPC may make such investigation, as is deemed necessary, to determine the ability of the bidder to perform the work; and the bidder shall furnish to the SJPC all such information and data for this purpose as the SJPC may request. SJPC reserves the right to reject any bid if the evidence submitted by, or the investigation of such bidder fails to satisfy the SJPC that such bidder is properly qualified to carry out the obligations of the Contract, and to complete the work therein contemplated. Conditional bids will not be accepted. See also paragraphs in these documents relating to subcontract work.

SUBMISSION OF BIDS

As set forth herein, bids must be submitted at the specified time due in sealed envelopes bearing the name and address of the bidder on the outside, and also bearing on the outside, reference to the work/project bid upon. Any bid may be submitted or withdrawn prior to the scheduled time for the opening of bids, or the authorized postponement thereof. Any bid received after the time and date specified in the Advertisement for Bids or addenda will not be considered. No bid may be withdrawn within ninety (90) days after the actual date of the opening thereof.

REJECTION OF BIDS

SJPC reserves the right to reject any or all bids received. SJPC also reserves the right to receive any and all bids in whatsoever form they may be, and to waive any informalities in said bids; or to award the work to whichever bidder or bidders it may be considered advantageous so to do, and in the best interest of the SJPC, regardless of bid prices.

Bids may also be rejected for any of the following reasons:

- a. All bids for any reason that is set out in N.J.S.A. 40A:11-13.2.
- b. If more than one bid is received from an individual, firm, or partnership, corporation, or association under the same name.
- c. Multiple bids from an agent representing competing bidders.
- d. The bid, in the discretion of the SJPC, is inappropriately balanced.

- e. The bidder is determined to possess Prior Negative Experience.
- f. If the successful bidder fails to enter a contract within twenty-one (21) days after expiration of any veto period, Sundays and holidays excepted, or as otherwise agreed upon by the parties. In this case at its option, the SJPC may accept the bid of the next lowest responsible bidder.

CONDITION OF WORK

Each bidder must inform themselves fully of the conditions relative to the construction under which the work will be performed. Failure to do so will not relieve a successful bidder of their obligation to furnish all material and labor necessary to carry out the provisions of the bid and any contract documents, and to complete the contemplated work for the construction set forth in their bid.

CONTRACTORS SCHEDULE

The successful bidder shall provide to the SJPC and Engineer of Record for the SJPC, a schedule of planned submittals and their proposed construction schedule within two (2) weeks after signing of a contract. The schedule of anticipated submittals for the work to be performed shall include a listing of shop drawings, catalogue cuts, material data sheets etc. together with forecasted dates for planned submission to the Engineer of Record. The successful bidder's schedule shall include milestone activities with durations and completion dates necessary for the performance of all contract construction work. The successful bidder is required to provide monthly updates to the aforementioned schedule for the duration of construction.

LIQUIDATED DAMAGES

In case the successful bidder fails to complete the work contracted for, in a manner satisfactory to and acceptable to the SJPC, within the stipulated time limit, then the said bidder shall and will pay to the SJPC for each and every day they, the contractor, shall be in default, the sum of Two Thousand Dollars (\$2,000.00) or the sum equal to 1/20 of one percent (1%) of the total consideration provided for under the contract, whichever sum is the greater, which sum per day is agreed upon, fixed and determined by the parties hereto to be liquidated damages and not a penalty.

SJPC shall recover said damages by deducting the amount thereof out of any monies which may be due or become due to successful bidder under the contract, or by an action of law against them or their surety, or by either or both of these methods.

In case the successful bidder shall be delayed due to the failure on the part of the SJPC to furnish anything on its part to be furnished, or of any other cause beyond the control of the said bidder, they shall be entitled to such an extension of time for the delivery of equipment, materials, work and supplies as is the judgement of SJPC shall be fair and just.

EVALUATION OF RESPONSES

Method

The bid review team for the SJPC will consist of individuals from the SJPC who will independently analyze each Bid Proposal. The evaluation team will analyze how the bidders' qualifications, experience, professional content and proposed methodology meet the SJPC's needs. Bid Proposals should be prepared simply and economically, providing straightforward, concise description of the bidder's capabilities to satisfy the requirements of this request.

Criteria

It is the policy of the SJPC that the selection of a successful bidder shall be on the basis of demonstrated competence, and on the professional qualifications necessary for the satisfactory performance of the work/services required. The SJPC will put each Bid Proposal submitted through a process of evaluation to determine responsiveness to all administrative, technical and legal requirements of the Request for Sealed Bid Proposals. Bid Proposals will be evaluated primarily on cost/cost effectiveness, but the bidder's qualifications, experience, project approach, and methodology may also be considered when evaluating the responsibility of a bid and bidder.

The evaluation criteria are intended to be used to make a recommendation to the SJPC Board of Directors, who will award the contract, but who are not bound to use the criteria or to award to bidder on the basis of the recommendation. Furthermore, the SJPC reserves the right to vary from this procedure as it determines to be in the SJPC's best interest.

SJPC 24-E7
BUILDING B SANITARY PUMP SATATION REPAIRS
BALZANO MARINE TERMINAL

BID FORM

Having carefully examined the Bid Documents, including, but not limited to, the Plans, Drawings, Technical Specifications, and form Agreement for this project, and having examined all conditions affecting the work, the undersigned Bidder proposes to complete the all the work as set forth therein, and to furnish all equipment, supervision, transportation, labor, materials, goods and services required to execute the work in accordance with the Bid Documents, including, but not limited to, the Plans, Drawings, Technical Specifications, and Agreement, for the following Unit Price Costs, unless noted otherwise:

It is understood and agreed that any incidental work necessary to complete the Project in its entirety will be included in the line items, unit prices and lump sum bid, whether the line item or items shall specifically state the nature of the incidental work. The line item or items which the incidental work, and the incidental costs, are included shall be selected by the Bidder. It is also understood and agreed that each line item of work shall include all supervision and personnel costs, markups, and other costs envisioned by the Bidder. In other words, all line item costs bid shall be “all-inclusive”. Therefore, the unit prices to be entered on this Bid Form are obtained by dividing the total cost bid to complete the line item by the quantity shown of the form. The bid shall be determined by adding all line item costs for all Bid Items under Base Bid. This grand total Base Bid Price shall constitute the Lump Sum Base Bid Cost of the Project.

Negotiations for the adjustments of the unit price of any item will be completed only when that item and other work or items affecting its quantity have been completed and the total net change in the quantity of such item can be ascertained with sufficient accuracy to determine if it be eligible for consideration in accordance with the foregoing provisions.

The Bidder must also furnish a price for **all** Optional Bids or Alternates requested, as well as **all** separate unit price items requested. Failure to do so will constitute an incomplete bid, which will be rejected by the South Jersey Port Corporation (“SJPC”).

The Bidder agrees that this bid will be valid and binding for a period of ninety (90) days to allow the SJPC time to evaluate the complete Bid Proposal to allow for the decision. The SJPC’s Engineer, or his designee, will officially notify the Bidder of the acceptance of their bid within ninety (90) days following the bid date pending compliance with delivering the requested documentation.

The undersigned accepts responsibility for having completely examined and understood the intent of the Bid Documents, including, but not limited to, Plans, Drawings, Technical Specifications, and form Agreement to be signed upon award; and, for having fully examined the site of the work; and, for having obtained all pertinent information affecting the work.

Bidder shall provide a lump sum proposal in US dollars to supply all necessary design services, materials, goods, labor, tools, consumables, transportation, watercraft, cranes, supervision, PPE, all materials and material controls, and any temporary facilities as necessary to provide for the complete and functional scope of work as described.

Estimated Time Required to Complete All Work in Calendar Days: 60_Days

Bidder shall provide rough schedule, including estimated start and completion dates.

Show major milestones including equipment delivery, field mobilization, pre-outage work, outage work, testing, and closeout.

All work shall be performed on weekdays during daylight hours. Work may be performed on Saturdays and/or other hours pending prior written approval by SJPC.

We Acknowledge Receipt of the Following Addenda:

1. ADDENDUM NO. _____ Dated: _____

2. ADDENDUM NO. _____ Dated: _____

3. ADDENDUM NO. _____ Dated: _____

4. ADDENDUM NO. _____ Dated: _____

If no addenda are received, indicate by printing or typing the word "NONE" in the space for first addenda.

**SJPC 24-E7
BUILDING B SANITARY PUMP STATION REPAIRS
BALZANO MARINE TERMINAL**

BID FORM

Item No.	Quan	Description	Amount
1	LS	Exploratory Excavation to locate Isolation Valve and Curb Box	\$
2	LS	Provide and install D.I. reducing tee, 2" valve and curb box riser. If needed.	\$
3	LS	Pump Station replacements including duplex motor controller, 2 grinder pumps, floats valves, check valves and piping.	\$
4	LS	Spare grinder pump	\$
5	LS	Electrical work to connect new motor controller, float valves and pumps.	\$
6	LS	Flushing station replacements including air release valve, 3" valve, isolation ball valve, and flushing connection.	\$
7	LS	Pressure test 2" CPVC discharge line. If directed.	\$
8	LS	TOTAL LUMP SUM BASE BID PRICE	\$
9		ALLOWANCE FOR UNFORSEEN REPAIRS - IF AND WHERE DIRECTED	\$10,000
10	LS	TOTAL CONTRACT AMOUNT	\$

TOTAL LUMP SUM BASE BID PRICE - Line 8 of Bid Form
(Printed / Written and Numerical)

\$ _____

TOTAL CONTRACT AMOUNT - Line 10 of Bid Form
(Printed / Written and Numerical)

\$ _____

Contractor: _____

Primary Contact Name: _____

Title: _____

Signature: _____

Date: _____

Business Address: _____

Phone No: _____

Email Address: _____

REQUIRED BID DOCUMENT SUBMISSION CHECKLIST

	GENERAL BID REQUIREMENTS	CHECKLIST
	Bid Security	<input type="checkbox"/>
	Certificate of Surety/Consent of Surety	<input type="checkbox"/>
	Letter of Transmittal	<input type="checkbox"/>
	Required Insurance Acknowledgement	<input type="checkbox"/>
	Bid Form	<input type="checkbox"/>
	Subcontractor Declaration	<input type="checkbox"/>

EXHIBIT #	BID REQUIREMENTS - Q EXHIBITS	CHECKLIST
Q1	Small Business Enterprise Questionnaire	<input type="checkbox"/>
Q2	Mandatory Equal Employment Opportunity "Exhibit A" Language (Goods/Service Contracts – if applicable)	N/A
Q3	Mandatory Equal Opportunity "Exhibit B" Language (Construction Contracts -if applicable)*	<input type="checkbox"/>
Q4	Stockholder Disclosure Certification	<input type="checkbox"/>
Q5	Non-Collusion Affidavit	<input type="checkbox"/>
Q6	Debarred List Affidavit	<input type="checkbox"/>
Q7	Affirmative Action Evidence for Procurement/Service	<input type="checkbox"/>
Q8	Business Registration Certificate	<input type="checkbox"/>
Q9	Set-Off for State Tax	<input type="checkbox"/>
Q11	Source Disclosure Form	<input type="checkbox"/>
Q12	Executive Order #189 Vendor Code of Ethics Affidavit	<input type="checkbox"/>
Q13	Executive Order #117 Two Year Chapter 51 / Vender Certification & Disclosure of Political Contributions	<input type="checkbox"/>
Q14	Executive Order #151 Contract Compliance	<input type="checkbox"/>
Q15	Employee Information Report – Form AA302	<input type="checkbox"/>
Q16	Ownership Disclosure Form (formerly E.O. #134)	<input type="checkbox"/>
Q17	Prevailing Wage Notification	<input type="checkbox"/>
Q18	Public Works Contract Registration	<input type="checkbox"/>
Q19	Buy America Notice	<input type="checkbox"/>
Q20	Pay to Play	<input type="checkbox"/>
Q21	Disclosure/Certification of Investment Activities in Iran	<input type="checkbox"/>
Q22	NJ Election Law Enforcement Commission (Elec) Affidavit	<input type="checkbox"/>
Q24	Certification of Non-involvement in Prohibited Activities in Russia or Belarus Pursuant to P.I.2022, c.3	N/A
Q25	Allen Act Acknowledgement	<input type="checkbox"/>
Q26	Assurance for Payment of Prevailing Wage	<input type="checkbox"/>
Q27	Confidentiality and Commitment to Defend	<input type="checkbox"/>
Q28	Disclosure of Investigations and Other Actions Involving the Vendor Form	<input type="checkbox"/>
Q29	Macbride Principles Form	<input type="checkbox"/>

CONSTRUCTION AGREEMENT

THIS AGREEMENT made this ____ day of _____, 2024, by and between the **SOUTH JERSEY PORT CORPORATION**, having its principal offices located at Two Aquarium Drive, Suite 100, Camden, New Jersey, 08103, hereinafter referred to as “Owner,” and _____, having its principal offices located at _____, hereinafter referred to as “Contractor.”

W I T N E S S E T H:

The Owner, South Jersey Port Corporation (“SJPC”), is an agency and instrumentality of the State of New Jersey with a mission to develop, maintain and operate marine terminals and related intermodal transportation infrastructure within the South Jersey Port District. The SJPC was established and created pursuant to the “South Jersey Port Corporation Act” (the Act), N.J.S.A. 12:11A-1 et seq.; and

1. That for and in consideration of the sum of \$ _____ **DOLLARS**, Contractor agrees to construct the _____ **Project Name** _____ (**hereinafter the “Project”**) in accordance with the Contract Documents hereinafter described and set forth.

2. That for and in consideration of the amount payable under this Agreement by the Owner, the Contractor agrees, at its own proper cost and expense, and with due skill and diligence, that it will perform the work for the Project in accordance with the Contract Documents, and in compliance with this Agreement.

3. Contractor agrees to receive as full compensation the amount stated above . Contractor shall be responsible for all loss or damage arising out of the furnishing of the work for the Project, or from any action of the elements; or from any unforeseen obstruction or difficulties

which may be encountered of every description connected with the furnishing of the aforesaid until the same have been accepted by the Owner.

4. To prevent all disputes and litigation, it is agreed by and between the parties to this Agreement that the Owner shall in all cases determine the services rendered and paid for under this Agreement, and as to the interpretation of the plans and specifications.

5. The Contract Documents shall consist of (1) All Bid Documents in the Request for Sealed Bid Proposals for the Project; (2) The Technical Specifications; (3) The Contractor's Proposal/Bid (as accepted); (4) This Agreement; (5) All Addenda (6) The General Conditions; and, (7) Any other written instructions or interpretations given by the Owner, or its representative. All of the Contract Documents are incorporated herein in their entirety by reference and made a part of this Agreement. The Contract Documents are incorporated into this Agreement by reference.

6. The Contractor shall furnish all of the material, supplies, tools, equipment, labor and other services necessary for the construction and completion of the Project described in the Contract Documents.

7. The Contractor shall commence the work required by the Contract Documents within seven (7) calendar days after the date of the issuance by the Owner of a notice to proceed. The Contractor shall complete all work required by the Contract Documents within ___ **calendar days** from and including the date of the written notice to proceed unless the period of completion is extended otherwise pursuant to the Contract Documents.

8. The Owner will pay to the Contractor, in the manner and at such times as set forth in the Contract Documents, such amounts as required by the Contract Documents. The

Contractor specifically agrees to the provision for liquidated damages contained in the Contract Documents.

9. Notwithstanding the fact that a dispute, controversy, or question shall have arisen between the Contractor and the Owner under this Contract, Contractor agrees that it will not directly or indirectly stop or delay the Work, or any part thereof, or stop or delay the delivery of any material required to be furnished to the Project site pending the resolution of such dispute, controversy or question. This provision does not excuse the Owner from its obligation to pay the Contractor that portion of an application for payment that is not in dispute, nor is it intended hereby that the Contractor is prohibited from stopping or delaying work in the event the Owner does not pay such undisputed amount in accordance with the terms and conditions hereof.

10. Where reference is made in this Contract to a provision of any of the Contract Documents, the reference refers to that provision as amended or supplemented by other provisions of the Contract Documents.

11. This Contract may be terminated by the Owner as provided in the Contract Documents; and the work may be suspended by the Owner as provided in the Contract Documents. This Contract may be terminated by the Owner for failure by the Contractor to provide the services, and prosecute and complete the work for the Project, in accordance with the Contract Documents. The Owner may also terminate this Contract for any other matter as authorized by law.

12. This Contract represents the entire and integrated agreement between the parties hereto and supersedes prior negotiations, representations, or agreements, either written or oral.

13. To the extent not superseded by federal law, this Contract shall be governed by the laws of the State of New Jersey.

14. The parties to this Contract agree that incorporated herein by reference is the mandatory language of subsection 3.6(a) of the Affirmative Action Regulations promulgated by the Treasurer of the State of New Jersey pursuant to P.L.1975, c.127, as amended and supplemented from time to time, and the Contractor and its subcontractor(s) agree to comply fully with the terms, provisions and obligations of said subsection.

15. Small Business Set-Aside. New Jersey's Small Business Set-Aside Program obligates the Owner to make 25% of all purchases for goods and services from small businesses. The Contractor shall execute the Small Business Enterprise Questionnaire, Bid requirement Q1, which be, and is, incorporated herein by reference.

The Contractor agrees to make a good faith effort to award at least 25% of this Contract to subcontractors registered by the Commerce Commission as an SBE. Subcontracting goals are not applicable if the Contractor is a registered Small Business Enterprise (SBE) firm.

16. The Contractor shall execute the Mandatory Equal Employment Opportunity Language, "Exhibit B", Bid requirement Q3, which be, and is, incorporated herein by reference.

17. Attached hereto and incorporated herein is(are) the Department of Labor and Workforce Development prevailing wage determination(s) for the locality and craft(s) that will be employed in the performance of work for the Project under this Contract. It is hereby stipulated that each individual who performs work under this Contract shall be paid not less than the prevailing wage rate to which that worker is entitled under the New Jersey Prevailing Wage Act, as reflected in the appropriate/applicable Department of Labor and Workforce Development prevailing wage rate determination.

18. In the event it is determined that any worker employed by the Contractor or any of its subcontractor(s) covered by this Contract has been paid a rate of wages less than the

prevailing wage rate required to be paid by this Contract, the Owner, the lessee to whom the Owner is leasing a property or premises or the lessor from whom the SJPC is leasing or will be leasing a property or premises, may terminate the Contractor's or subcontractor's right to proceed with the work at the Project, or such part of the work, as to which there has been a failure to pay required wages, and to prosecute the work to completion or otherwise. The Contractor and his sureties shall be liable to the Owner, any lessee to whom the Owner is leasing a property or premises, or to any lessor from whom the Owner is leasing or will be leasing a property or premises, for any excess costs occasioned by the termination of the Contractor's or subcontractor's right to proceed with the work, or such part of the work as to which there has been a failure to pay required wages.

19. The undersigned does hereby warrant and represent that this Contract has not been solicited or secured, directly or indirectly, in a manner contrary to the laws of the State of New Jersey, and that said laws have not been violated and shall not be violated as they relate to the procurement or the performance of this Contract by any conduct, including, the paying or giving of any fee, commission, compensation, gift, gratuity or consideration of any kind, directly or indirectly, to any Owner employee, officer or official.

20. The address given below shall be the address of the representative of the parties to which all notices and reports required by this Contract shall be sent by certified mail, return receipt requested.

As to the Owner:

Mr. Andrew Saporito, Executive Director
SOUTH JERSEY PORT CORPORATION
Two Aquarium Drive
Camden, NJ 08103

As to the Contractor:

(insert address)

21. If it becomes necessary for the Contractor, either as principal or by agent or employee, to enter upon the premises or property of the Owner in order to construct, erect, inspect, make delivery or remove property hereunder, the Contractor hereby covenants and agrees to take, use, provide and make all proper, necessary and sufficient precautions, safeguards and protections against the occurrence of happenings or any accidents, injuries damages or hurt to any person or property during the progress of the work herein covered. Contractor shall hold the Owner, its Chairman, commissioners, directors, members, officers and employees harmless from and against all claims, suits, and judgments of every kind and description arising from any damage to or loss of property of the Owner, Contractor, or their respective agents, servants or employees, or any other person, or injury to or death of persons, including agents, servants, or employees of Owner or Contractor, or any other person, arising directly or indirectly from the services provided by this Agreement, except that which is due solely to the fault or negligence of Owner, its agents, servants or employees. The Contractor will carry insurance and will indemnify the Owner, its Chairman, commissioners, directors, members, officers and employees from and against any such claim for loss, damage or injury to property or person arising out of the services covered by this Agreement and the use, misuse or failure of any equipment used by the Contractor or his employees or agents, and shall provide certification of such insurance to the Owner.

22. The Contractor shall submit a properly completed Affirmative Action Form AA-201 (Initial Project Workforce Report – Construction) prior to execution of this Contract. The Contractor agrees thereafter to submit once a month, prior to the receipt of any monthly payment, Affirmative Action Form AA-202 (Monthly Project Workforce Report).

23. Business Registration Certificate, Bid requirement Q8. The Contractor shall provide written notice to its subcontractors of the responsibility to submit proof of business registration to the Contractor. The requirement of proof of business registration extends down through all levels (tiers) of the Project.

Before final payment on this Contract is made by the Owner, the Contractor shall submit an accurate list and the proof of business registration of each subcontractor or supplier used in the fulfillment of the Contract or shall attest that no subcontractors were used.

For the term of this Contract, the Contractor and each of its affiliates, and a subcontractor and each of its affiliates, [N.J.S.A. 52:32-44(g)(3)] shall collect and remit to the Director, New Jersey Division of Taxation, the use tax due pursuant to the Sales and Use Tax Act on all sales of tangible personal property delivered into this State, regardless of whether the tangible personal property is intended for a contract with a contracting agency.

A business organization that fails to provide a copy of a business registration as required pursuant to Section 1 of P.L. 2001, c. 134 (C.52:32-44 *et al.*) or subsection e. or f. of Section 92 P.L. 1977, c.110 (C.5:12-92), or that provides false business registration information under the requirements of either of those sections, shall be liable for a penalty of \$25 for each day of violation, not to exceed \$50,000 for each business registration copy not properly provided under a contract with a contracting agency.

24. This Contract, together with the Contract Documents, forms the entire Contract between the parties, and they are as fully a part of this Contract as if hereto attached or herein repeated; and all of same are incorporated herein by reference.

25. The Owner and the Contractor for themselves, their heirs, executors, administrators, successors, or assigns, hereby agree to the full performance of the covenants herein contained.

IN WITNESS WHEREOF, the parties hereto have set their hands and seals the day and year first written above.

WITNESS & ATTEST:

**SOUTH JERSEY PORT
CORPORATION OWNER**

ALVIN COOLEY
Senior Purchasing Agent

By

ANDREW SAPORITO
Executive Director

(Seal)

WITNESS & ATTEST:

[CONTRACTOR]

Secretary

By

President or Owner

(Seal)



SOUTH JERSEY PORT CORPORATION

GENERAL REQUIRED DOCUMENTS FOR BID AND PROPOSAL PROJECTS

BID SECURITY

Attach Bid Security (Bid Bond) in the amount of 10% of the bid, but not in excess of \$20,000.00.

(ATTACH YOUR BID SECURITY TO THIS SHEET)

(Name of Company)

(Signature of Representative)

(Date)

CONSENT OF SURETY

Attach Consent of Surety from a Surety Company, meeting the requirements, described herein, stating that if the bidder is awarded the contract that the surety company will supply a performance bond for the contract.

Sample wording is as shown below:

CONSENT OF SURETY

_____, _____ duly qualified to transact
(Name of Surety Company) (address)

business in the State of New Jersey, hereby agrees that if _____
(insert name of Bidder)

located at _____ is the successful Bidder for
(Address)

_____ it as surety, will provide the Bidder with a
(describe contract work here)
bond in such sum as is required in the advertisement or in the specifications.

Signed, sealed and dated this _____ day of _____, 20 ____ .

(Name of Surety Company)

By _____
(Name of attorney in fact)

NOTE: This form OR a Consent of Surety supplied by the Bidder's Surety Company is required with all bid submissions.

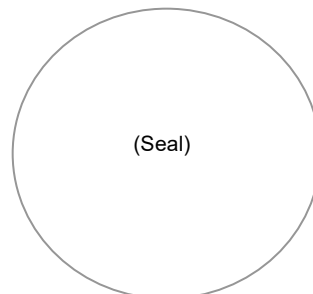

REQUIRED INSURANCE ACKNOWLEDGMENT

I acknowledge I have fully read and understand the insurance requirements as outlined in the Bid Specifications.

Furthermore, I have submitted a Certificate of Insurance or a letter from our company's insurance carrier stating their ability to provide a certificate of insurance if awarded a contract.

(Name of Company)

(Signature of Representative)

(Date)

SUBCONTRACTOR DECLARATION

Each bidder shall set forth in the bid the names and addresses of the subcontractors being utilized for this project and their trade. Failure of the bidder to name said subcontractors will be cause for rejection of the bid.

Our company will **not** be utilizing subcontractors for this project.

Our company will be utilizing subcontractors for this project and have attached a separate sheet with their names, addresses, and trades.

(Name of Company)

(Signature of Representative)

(Date)



SOUTH JERSEY PORT CORPORATION

Q EXHIBITS FOR BID AND PROPOSAL PROJECTS

Small Business Enterprise Questionnaire

South Jersey Port Corporation

FOR INFORMATION PURPOSES

New Jersey’s Small Business Set-Aside Program obligates the South Jersey Port Corporation to make 25% of all purchase for goods and services for small businesses. Firms classified as Small Business Enterprises must be registered with the New Jersey Business Action Center.

Registration instructions can be obtained by visiting the State’s website at:

www.nj.gov/njbusiness/contracting/sbsa/ This is not a Set-Aside bid; however South Jersey Port Corporation requires completion of this form to allow the South Jersey Port Corporation to track its Set-Aside obligations are pursuant to Executive Order #71 of former Governor James E. McGreevey and Executive Order #34 of former Governor John S. Corzine.

The South Jersey Port Corporation requests the following:

Our firm is certified/registered with the State of New Jersey Set-Aside Program. Yes No
(Circle One, attach a copy of the certification and enter certification number below)

Certification # _____

Check Here

SBE (Small Business Enterprise) _____

MBE (Minority Business Enterprise) _____

WBE (Woman Business Enterprise) _____

None of the Above _____

If yes, please provide Certification & Documentation of MBE & WBE.

NOTE: The South Jersey Port Corporation, being a body politic, is not subject to municipal, state, or federal taxes.

**REQUIRED AFFIRMATIVE ACTION EVIDENCE FOR PROCUREMENT
PROFESSIONAL AND SERVICES CONTRACTS**

All successful vendors must submit one of the following with seven (7) days of the notice to intent to award:

- 1. A photocopy of their Federal Letter of Affirmative Action Plan Approval
Or
- 2. A photocopy of their Certificate of Employee Information Report
Or
- 3. A completed Affirmative Action Employee Information Report (AA302)

PLEASE COMPLETE THE FOLLOWING QUESTIONNAIRE AS PART OF THE BID PACKAGE IN THE EVENT THAT YOU OR YOUR FIRM IS AWARDED THIS CONTRACT

- 1. Our company has a Federal Letter of Affirmative Action Plan Approval
Yes _____ No _____
- 2. Our company has a Certificate of Employee Information Report
Yes _____ No _____
- 3. Our company has neither of the above. Please send Form AA302
(AFFIRMATIVE ACTION EMPLOYEE INFORMATION REPORT)
Check Here _____

NOTE: This form will be sent only if your company is awarded the bid,

I certify that the above information is correct to the best of my knowledge.

NAME _____
(Please type or print)

SIGNATURE _____

TITLE _____

DATE _____

PHONE NUMBER _____

FAX NUMBER _____

EXHIBIT A

MANDATORY EQUAL EMPLOYMENT OPPORTUNITY LANGUAGE N.J.S.A. 10:5-31 et seq. (P.L.1975, c.127) N.J.A.C. 17:27 et seq.

GOODS, GENERAL SERVICES, AND PROFESSIONAL SERVICES CONTRACTS

During the performance of this contract, the contractor agrees as follows:

The contractor or subcontractor, where applicable, will not discriminate against any employee or applicant for employment because of age, race, creed, color, national origin, ancestry, marital status, affectional or sexual orientation, gender identity or expression, disability, nationality or sex. Except with respect to affectional or sexual orientation and gender identity or expression, the contractor will ensure that equal employment opportunity is afforded to such applicants in recruitment and employment, and that employees are treated during employment, without regard to their age, race, creed, color, national origin, ancestry, marital status, affectional or sexual orientation, gender identity or expression, disability, nationality or sex. Such equal employment opportunity shall include, but not be limited to the following: employment, upgrading, demotion, or transfer; recruitment or recruitment advertising; layoff or termination; rates of pay or other forms of compensation; and selection for training, including apprenticeship. The contractor agrees to post in conspicuous places, available to employees and applicants for employment, notices to be provided by the Public Agency Compliance Officer setting forth provisions of this nondiscrimination clause. The contractor or subcontractor, where applicable will, in all solicitations or advertisements for employees placed by or on behalf of the contractor, state that all qualified applicants will receive consideration for employment without regard to age, race, creed, color, national origin, ancestry, marital status, affectional or sexual orientation, gender identity or expression, disability, nationality or sex.

The contractor or subcontractor will send to each labor union, with which it has a collective bargaining agreement, a notice, to be provided by the agency contracting officer, advising the labor union of the contractor's commitments under this chapter and shall post copies of the notice in conspicuous places available to employees and applicants for employment.

The contractor or subcontractor, where applicable, agrees to comply with any regulations promulgated by the Treasurer pursuant to N.J.S.A. 10:5-31 et seq., as amended and supplemented from time to time and the Americans with Disabilities Act.

The contractor or subcontractor agrees to make good faith efforts to meet targeted county employment goals established in accordance with N.J.A.C. 17:27-5.2.

EXHIBIT A (Cont.)

The contractor or subcontractor agrees to inform in writing its appropriate recruitment agencies including, but not limited to, employment agencies, placement bureaus, colleges, universities, and labor unions, that it does not discriminate on the basis of age, race, creed, color, national origin, ancestry, marital status, affectional or sexual orientation, gender identity or expression, disability, nationality or sex, and that it will discontinue the use of any recruitment agency which engages in direct or indirect discriminatory practices.

The contractor or subcontractor agrees to revise any of its testing procedures, if necessary, to assure that all personnel testing conforms with the principles of job related testing, as established by the statutes and court decisions of the State of New Jersey and as established by applicable Federal law and applicable Federal court decisions.

In conforming with the targeted employment goals, the contractor or subcontractor agrees to review all procedures relating to transfer, upgrading, downgrading and layoff to ensure that all such actions are taken without regard to age, race, creed, color, national origin, ancestry, marital status, affectional or sexual orientation, gender identity or expression, disability, nationality or sex, consistent with the statutes and court decisions of the State of New Jersey, and applicable Federal law and applicable Federal court decisions.

The contractor shall submit to the public agency, after notification of award but prior to execution of a goods and services contract, one of the following three documents:

Letter of Federal Affirmative Action Plan Approval;

Certificate of Employee Information Report; or

Employee Information Report Form AA-302 (electronically provided by the Division and distributed to the public agency through the Division's website at:

http://www.state.nj.us/treasury/contract_compliance

The contractor and its subcontractors shall furnish such reports or other documents to the Division of Purchase & Property, CCAU, EEO Monitoring Program as may be requested by the office from time to time in order to carry out the purposes of these regulations, and public agencies shall furnish such information as may be requested by the Division of Purchase & Property, CCAU, EEO Monitoring Program for conducting a compliance investigation pursuant to N.J.A.C. 17:27-1.1 et seq.

EXHIBIT B

MANDATORY EQUAL EMPLOYMENT OPPORTUNITY LANGUAGE N.J.S.A. 10:5-31 et seq. (P.L.1975, c.127) N.J.A.C. 17:27-1.1 et seq.

CONSTRUCTION CONTRACTS

During the performance of this contract, the contractor agrees as follows:

The contractor or subcontractor, where applicable, will not discriminate against any employee or applicant for employment because of age, race, creed, color, national origin, ancestry, marital status, affectional or sexual orientation, gender identity or expression, disability, nationality or sex. Except with respect to affectional or sexual orientation and gender identity or expression, the contractor will ensure that equal employment opportunity is afforded to such applicants in recruitment and employment, and that employees are treated during employment, without regard to their age, race, creed, color, national origin, ancestry, marital status, affectional or sexual orientation, gender identity or expression, disability, nationality or sex. Such equal employment opportunity shall include, but not be limited to the following: employment, upgrading, demotion, or transfer; recruitment or recruitment advertising; layoff or termination; rates of pay or other forms of compensation; and selection for training, including apprenticeship. The contractor agrees to post in conspicuous places, available to employees and applicants for employment, notices to be provided by the Public Agency Compliance Officer setting forth provisions of this nondiscrimination clause.

The contractor or subcontractor, where applicable will, in all solicitations or advertisements for employees placed by or on behalf of the contractor, state that all qualified applicants will receive consideration for employment without regard to age, race, creed, color, national origin, ancestry, marital status, affectional or sexual orientation, gender identity or expression, disability, nationality or sex.

The contractor or subcontractor will send to each labor union, with which it has a collective bargaining agreement, a notice, to be provided by the agency contracting officer, advising the labor union or worker's representative of the contractor's commitments under this act and shall post copies of the notice in conspicuous places available to employees and applicants for employment.

The contractor or subcontractor, where applicable, agrees to comply with any regulations promulgated by the Treasurer, pursuant to N.J.S.A. 10:5-31 et seq., as amended and supplemented from time to time and the Americans with Disabilities Act.

When hiring or scheduling workers in each construction trade, the contractor or subcontractor agrees to make good faith efforts to employ minority and women workers in each construction trade consistent with the targeted employment goal prescribed by N.J.A.C. 17:27-7.2; provided, however, that the Dept. of LWD, Construction EEO Monitoring Program, may, in its discretion, exempt a contractor or subcontractor from compliance with the good faith procedures prescribed by the following provisions, A, B, and C, as long as the Dept. of LWD, Construction EEO Monitoring Program is satisfied that the contractor or subcontractor is employing workers

EXHIBIT B (Cont.)

provided by a union which provides evidence, in accordance with standards prescribed by the Dept. of LWD, Construction EEO Monitoring Program, that its percentage of active “card carrying” members who are minority and women workers is equal to or greater than the targeted employment goal established in accordance with N.J.A.C. 17:27-7.2. The contractor or subcontractor agrees that a good faith effort shall include compliance with the following procedures:

(A) If the contractor or subcontractor has a referral agreement or arrangement with a union for a construction trade, the contractor or subcontractor shall, within three business days of the contract award, seek assurances from the union that it will cooperate with the contractor or subcontractor as it fulfills its affirmative action obligations under this contract and in accordance with the rules promulgated by the Treasurer pursuant to N.J.S.A. 10:5-31 et. seq., as supplemented and amended from time to time and the Americans with Disabilities Act. If the contractor or subcontractor is unable to obtain said assurances from the construction trade union at least five business days prior to the commencement of construction work, the contractor or subcontractor agrees to afford equal employment opportunities minority and women workers directly, consistent with this chapter. If the contractor’s or subcontractor’s prior experience with a construction trade union, regardless of whether the union ‘has provided said ‘assurances, indicates a significant possibility that the trade union will not refer sufficient minority and women workers consistent with affording equal employment opportunities as specified in this chapter, the contractor or subcontractor agrees to be prepared to provide such opportunities to minority and women workers directly, consistent with this chapter, by complying with the hiring or scheduling procedures prescribed under (B) below; and the contractor or subcontractor further agrees to take said action immediately if it determines that the union is not referring minority and women workers consistent with the equal employment opportunity goals set forth in this chapter.

(B) If good faith efforts to meet targeted employment goals have not or cannot be met for each construction trade by adhering to the procedures of (A) above, or if the contractor does not have a referral agreement or arrangement with a union for a construction trade, the contractor or subcontractor agrees to take the following actions:

(1) To notify the public agency compliance officer, the Dept. of LWD, Construction EEO Monitoring Program, and minority and women referral organizations listed by the Division pursuant to N.J.A.C. 17:27-5.3, of its workforce needs, and request referral of minority and women workers.

(2) To notify any minority and women workers who have been listed with it as awaiting available vacancies;

(3) Prior to commencement of work, to request that the local construction trade union refer minority and women workers to fill job openings, provided the contractor or subcontractor has a referral agreement or arrangement with a union for the construction trade;

EXHIBIT B (Cont.)

(4) To leave standing requests for additional referral to minority and women workers with the local construction trade union, provided the contractor or subcontractor has a referral agreement or arrangement with a union for the construction trade, the State Training and Employment Service and other approved referral sources in the area;

(5) If it is necessary to lay off some of the workers in a given trade on the construction site, layoffs shall be conducted in compliance with the equal employment opportunity and nondiscrimination standards set forth in this regulation, as well as with applicable Federal and State court decisions;

(6) To adhere to the following procedure when minority and women workers apply or are referred to the contractor or subcontractor:

(i) The contractor or subcontractor shall interview the referred minority or women worker.

(ii) If said individuals have never previously received any document or certification signifying a level of qualification lower than that required in order to perform the work of the construction trade, the contractor or subcontractor shall in good faith determine the qualifications of such individuals. The contractor or subcontractor shall hire or schedule those individuals who satisfy appropriate qualification standards in conformity with the equal employment opportunity and non-discrimination principles set forth in this chapter. However, a contractor or subcontractor shall determine that the individual at least possesses the requisite skills, and experience recognized by a union, apprentice program or a referral agency, provided the referral agency is acceptable to the Dept. of LWD, Construction EEO Monitoring Program. If necessary, the contractor or subcontractor shall hire or schedule minority and women workers who qualify as trainees pursuant to these rules. All of the requirements, however, are limited by the provisions of (C) below.

(iii) The name of any interested women or minority individual shall be maintained on a waiting list and shall be considered for employment as described in (i) above, whenever vacancies occur. At the request of the Dept. of LWD, Construction EEO Monitoring Program, the contractor or subcontractor shall provide evidence of its good faith efforts to employ women and minorities from the list to fill vacancies.

(iv) If, for any reason, said contractor or subcontractor determines that a minority individual or a woman is not qualified or if the individual qualifies as an advanced trainee or apprentice, the contractor or subcontractor shall inform the individual in writing of the reasons for the determination, maintain a copy of the determination in its files, and send a copy to the public agency compliance officer and to the Dept. of LWD, Construction EEO Monitoring Program.

(7) To keep a complete and accurate record of all requests made for the referral of workers in any trade covered by the contract, on forms made available by the Dept. of LWD, Construction EEO Monitoring Program and submitted promptly to the Dept. of LWD, Construction EEO Monitoring Program upon request.

EXHIBIT B (Cont.)

(C) The contractor or subcontractor agrees that nothing contained in (B) above shall preclude the contractor or subcontractor from complying with the union hiring hall or apprenticeship policies in any applicable collective bargaining agreement or union hiring hall arrangement, and, where required by custom or agreement, it shall send journeymen and trainees to the union for referral, or to the apprenticeship program for admission, pursuant to such agreement or arrangement. However, where the practices of a union or apprenticeship program will result in the exclusion of minorities and women or the failure to refer minorities and women consistent with the targeted county employment goal, the contractor or subcontractor shall consider for employment persons referred pursuant to (B) above without regard to such agreement or arrangement; provided further, however, that the contractor or subcontractor shall not be required to employ women and minority advanced trainees and trainees in numbers which result in the employment of advanced trainees and trainees as a percentage of the total workforce for the construction trade, which percentage significantly exceeds the apprentice to journey worker ratio specified in the applicable collective bargaining agreement, or in the absence of a collective bargaining agreement, exceeds the ratio established by practice in the area for said construction trade. Also, the contractor or subcontractor agrees that, in implementing the procedures of (B) above, it shall, where applicable, employ minority and women workers residing within the geographical jurisdiction of the union.

After notification of award, but prior to signing a construction contract, the contractor shall submit to the public agency compliance officer and the Dept. of LWD, Construction EEO Monitoring Program an initial project workforce report (Form AA-201) electronically provided to the public agency by the Dept. of LWD, Construction EEO Monitoring Program, through its website, for distribution to and completion by the contractor, in accordance with N.J.A.C. 17:27-7. The contractor also agrees to submit a copy of the Monthly Project Workforce Report once a month thereafter for the duration of this contract to the Dept. of LWD, Construction EEO Monitoring Program, and to the public agency compliance officer.

The contractor agrees to cooperate with the public agency in the payment of budgeted funds, as is necessary, for on-the-job and/or off-the job programs for outreach and training of minorities and women.

(D) The contractor and its subcontractors shall furnish such reports or other documents to the Dept. of LWD, Construction EEO Monitoring Program as may be requested by the Dept. of LWD, Construction EEO Monitoring Program from time to time in order to carry out the purposes of these regulations, and public agencies shall furnish such information as may be requested by the Dept. of LWD, Construction EEO Monitoring Program for conducting a compliance investigation pursuant to N.J.A.C. 17:27-1.1 et seq.

STOCKHOLDER DISCLOSURE CERTIFICATION

Q4

Name of Business:

I certify that the list below contains the names and home addresses of all stockholders holding 10% or more of the issued and outstanding stock of the undersigned.

OR

I certify that no one stockholder owns 10% or more of the issued and outstanding stock of the undersigned.

Check the box that represents the type of business organization:

Partnership

Corporation

Sole Proprietorship

Limited Partnership

Limited Liability Corporation

Limited Liability Partnership

Subchapter S Corporation

Sign and notarize the form below, and, if necessary, complete the stockholder list below.

Stockholders:

Name:	Name:
Home Address:	Home Address:
Name:	Name:
Home Address:	Home Address:
Name:	Name:
Home Address:	Home Address:

Subscribed and sworn before me this ___ day of _____, 20 __.	_____
(Notary Public)	(Affiant)
My Commission expires:	_____
	(Print name & title of affiant)
	(Corporate Seal)

NON-COLLUSION AFFIDAVIT

State of New Jersey

County of _____

SS:

I, _____ residing in _____
(name of affiant) (name of municipality)

in the County of _____ and State of _____

of full age, being duly sworn according to law on my oath depose and say that:

I am _____ of the firm of _____
(title or position) (name of firm)

the bidder making this Proposal for the bid entitled _____,
(title of bid proposal)

and that I executed the said proposal with full authority to do so that said bidder has not, directly or indirectly entered into any agreement, participated in any collusion, or otherwise taken any action in restraint of free, competitive bidding in connection with the above named project; and that all statements contained in said proposal and in this affidavit are true and correct, and made with full knowledge that South Jersey Port Corp. relies upon the truth of the statements contained in said Proposal and in the statements contained in this affidavit in awarding the contract for the said project.

I further warrant that no person or selling agency has been employed or retained to solicit or secure such contract upon an agreement or understanding for a commission, percentage, brokerage, or contingent fee, except bona fide employees or bona fide established commercial or selling agencies maintained by _____.
(name of firm)

Subscribed and sworn to

before me, this day

_____, 2____

Signature

(Type or print name of affiant under signature)

Notary public of

My Commission expires _____

(Seal)

STATE OF NEW JERSEY DEBARRED LIST AFFIDAVIT

I, _____ of the City of _____ in the County of _____ and the State of _____ of full age, being duly sworn according to law on my oath depose that:

I am _____, an officer of the firm of Bid for the above named work, and that I executed the said Bid with full authority to do so; that said bidder at the time of making of this bid is not included on the State of New Jersey, Department of the Treasurer’s List of Debarred, Suspended and Disqualified Bidders and that all statements contained in said Bid and in this Affidavit are true and correct, and made with the full knowledge that the City relies upon the truth of the statements contained in said Bid and in statements contained in the Affidavit in awarding the contract for said work. The undersigned further warrants that should the name of the firm making this bid appear on the State Treasurer’s List of Debarred, Suspended and Disqualified Bidders at any time prior to, and during the life of this Contract, including the Guarantee Period, that the City shall be immediately so notified by the signatory of this Eligibility Affidavit.

The undersigned understands that the firm making the bid as a Contractor is subject to debarment, suspension and / or disqualification in contracting with the State of New Jersey and the Department of Environmental Protection if the Contractor, pursuant to N.J.A.C. 7:1-5.2, commits any of the acts listed therein, and as determined according to applicable law and regulation.

Name of Bidder (Type or Print): _____

Signature of Bidder: _____

Address of Bidder: _____

Name & Title of Affiant: _____

Signature of Affiant: _____

Notarization Section

Subscribed and Sworn before me this _____ day of _____, 20____.

Notary Public

(Seal)

Affirmative Action Evidence for Procurement/Service

Please fill out the following forms AA201 & AA202.

STATE OF NEW JERSEY

DEPARTMENT OF LABOR & WORKFORCE DEVELOPMENT
CONSTRUCTION EEO COMPLIANCE MONITORING PROGRAM

FORM AA-201

Revised 11/11

INITIAL PROJECT WORKFORCE REPORT CONSTRUCTION

Assignment

Code

For instructions on completing the form, go to: https://www.nj.gov/treasury/contract_compliance/documents/pdf/forms/aa201ins.pdf

1. FID NUMBER		2. CONTRACTOR ID NUMBER		5. NAME AND ADDRESS OF PUBLIC AGENCY AWARING CONTRACT											
3. NAME AND ADDRESS OF PRIME CONTRACTOR				Name:											
				Address:											
(Name)				CONTRACT NUMBER				DATE OF AWARD		DOLLAR AMOUNT OF AWARD					
(Street Address)				6. NAME AND ADDRESS OF PROJECT						7. PROJECT NUMBER					
(City) (State) (Zip Code)												Name:			
4. IS THIS COMPANY MINORITY OWNED [] OR WOMAN OWNED []				Address:											
				9. TRADE OR CRAFT				PROJECTED TOTAL EMPLOYEES				PROJECTED MINORITY EMPLOYEES			
MALE		FEMALE						MALE		FEMALE					
J		AP		J		AP		J		AP		PROJECTED PHASE - IN DATE		PROJECTED COMPLETION DATE	
1. ASBESTOS WORKER															
2. BRICKLAYER OR MASON															
3. CARPENTER															
4. ELECTRICIAN															
5. GLAZIER															
6. HVAC MECHANIC															
7. IRONWORKER															
8. OPERATING ENGINEER															
9. PAINTER															
10. PLUMBER															
11. ROOFER															
12. SHEET METAL WORKER															
13. SPRINKLER FITTER															
14. STEAMFITTER															
15. SURVEYOR															
16. TILER															
17. TRUCK DRIVER															
18. LABORER															
19. OTHER															
20. OTHER															

I hereby certify that the foregoing statements made by me are true. I am aware that if any of the foregoing statements are willfully false, I am subject to punishment.

(Signature)

10. (Please Print Your Name)

(Title)

(Area Code)

(Telephone Number)

(Ext.)

(Date)

State Of New Jersey
 Department of Labor & Workforce Development
 Construction EEO Compliance Monitoring Program

MONTHLY PROJECT WORKFORCE REPORT - CONSTRUCTION

For instructions on completing the form, go to: https://www.nj.gov/treasury/contract_compliance/documents/pdf/forms/aa202ins.pdf			3. F ID or SS Number		
1. Name and address of Prime Contractor		2. Contractor ID Number		4. Reporting Period	
(NAME)			5. Public Agency Awarding Contract		
(ADDRESS)			Date of Award		
(CITY)		(STATE)		(ZIP CODE)	
6. Name and Location of Project				County	7. Project ID Number

8. CONTRACTOR NAME (LIST PRIME CONTRACTOR WITH SUBS FOLLOWING)	9. PERCENT OF WORK COMPLETED	10. TRADE OR CRAFT	CLASSIFICATION (SEE REVERSE)	11. NUMBER OF EMPLOYEES						12. TOTAL	13. WORK HOURS		14. % OF WORK HRS		15. CUM. WORK HRS		16. CUM. % OF W/H			
				A.	B.	C.	D.	E.	F.	NO. OF MIN. EMP.	TOTAL WORK HOURS	A.	B.	A.	B.	TOTAL WORK HOURS	A.	B.	A.	B.
				TOTAL	BLACK	HISPANIC	AMERICAN INDIAN	ASIAN	FEMALES			MIN.	FEMALE W/H	% OF MIN. W/H	% OF FEMALE W/H	MIN.	FEMALE HOURS	% OF MIN. W/H	% OF FEM. W/H	
			J																	
			AP																	
			J																	
			AP																	
			J																	
			AP																	
			J																	
			AP																	
			J																	
			AP																	

17. COMPLETED BY (PRINT OR TYPE)

(NAME) (SIGNATURE) (TITLE)

(AREA CODE) (TELEPHONE NUMBER) (EXT.) (DATE)

Sample Certificate of Employee Information Report

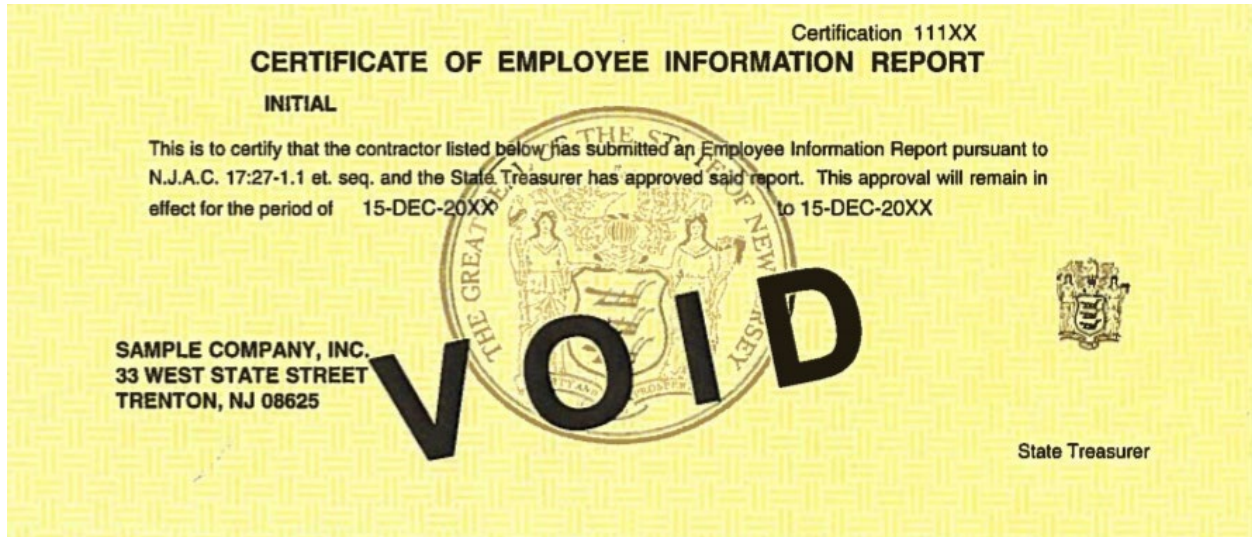

If you are unable to provide your Certificate of Employee Information Report, please fill out the following form and follow the steps.



STATE OF NEW JERSEY
DEPARTMENT OF THE TREASURY
Division of Purchase & Property, Contract Compliance Audit Unit
EEO Monitoring Program

DUPLICATE CERTIFICATE OF EMPLOYEE INFORMATION REPORT REQUEST

IMPORTANT-FAILURE TO PROPERLY COMPLETE THE ENTIRE FORM AND SUBMIT THE REQUIRED \$75.00 FEE (Non-Refundable) MAY DELAY ISSUANCE OF YOUR DUPLICATE CERTIFICATE OF EMPLOYEE INFORMATION REPORT.

SECTION A - COMPANY IDENTIFICATION

1. FID. NO. OR SOCIAL SECURITY	2. ASSIGNED CERTIFICATION NUMBER	ISSUE DATE	EXPIRATION DATE
	<input type="text"/>	<input type="text"/>	<input type="text"/>

3. COMPANY NAME

4. STREET	CITY	COUNTY	STATE	ZIP CODE

5. REASON FOR REQUEST OF DUPLICATE CERTIFICATE

1. Lost Certificate 2. Damaged 3. Other (Specify)

SECTION B - SIGNATURE AND IDENTIFICATION

6. NAME OF PERSON COMPLETING FORM (Print or Type)	SIGNATURE	TITLE	DATE MO DAY YEAR

7. ADDRESS NO. & STREET	CITY	COUNTY	STATE	ZIP CODE	PHONE (AREA CODE, NO., EXTENSION)

I certify that the information on this Form is true and correct.

SECTION C - OFFICIAL USE ONLY

RECEIVED DATE:		DIVISION OF REVENUE DLN #:	

INSTRUCTIONS FOR COMPLETING DUPLICATE CERTIFICATE REQUEST

- ITEM 1** - Enter the Federal Identification Number assigned by the Internal Revenue Service, or if a Federal Employer Identification Number has been applied for, or if your business is such that you have not or will not receive a Federal Employer Identification Number, enter the Social Security Number of the owner or of one partner, in the case of a partnership.
- ITEM 2** - Enter the Certificate Number that was assigned to your company along with the Issue Date and Expiration Date (If available).
- ITEM 3** - Enter the name by which the company is identified.
- ITEM 4** - Enter the physical location of the company. Include City, County, State and Zip Code.
- ITEM 5** - Enter the reason for requesting a Duplicate Certificate of Employee Information Report.
- ITEM 6** - Print or type the name of the person completing the form. Include the signature, title and date.
- ITEM 7** - Enter the physical location where the form is being completed. Include City, State, Zip Code and Phone Number.

RETAIN A COPY OF THIS REQUEST FOR THE VENDOR'S OWN FILES AND FORWARD ONE COPY WITH A CHECK IN THE AMOUNT OF \$75.00 (Non-Refundable Fee) PAYABLE TO "THE TREASURER, STATE OF NEW JERSEY" TO:

**NJ Department of the Treasury
Division of Purchase & Property
Contract Compliance Audit Unit
EEO Monitoring Program
PO Box 206**

Trenton, New Jersey 08625-0206

Telephone No. (609) 292-5473

PLEASE ALLOW 15 BUSINESS DAYS FOR PROCESSING THE DUPLICATE CERTIFICATE

PUBLIC CONTRACT EEO/AA COMPLIANCE PROCEDURES FLOW CHART

EEO/AA Procedures in Awarding Public Contracts

Public Agency

- Include Mandatory Language in advertisements for receipt of bids, solicitation and/or request for proposals.
 - Include appropriate Mandatory Language in contracts and bid specifications.
 - Obtain Required EEO/AA evidence from contractor or vendor.

Vender

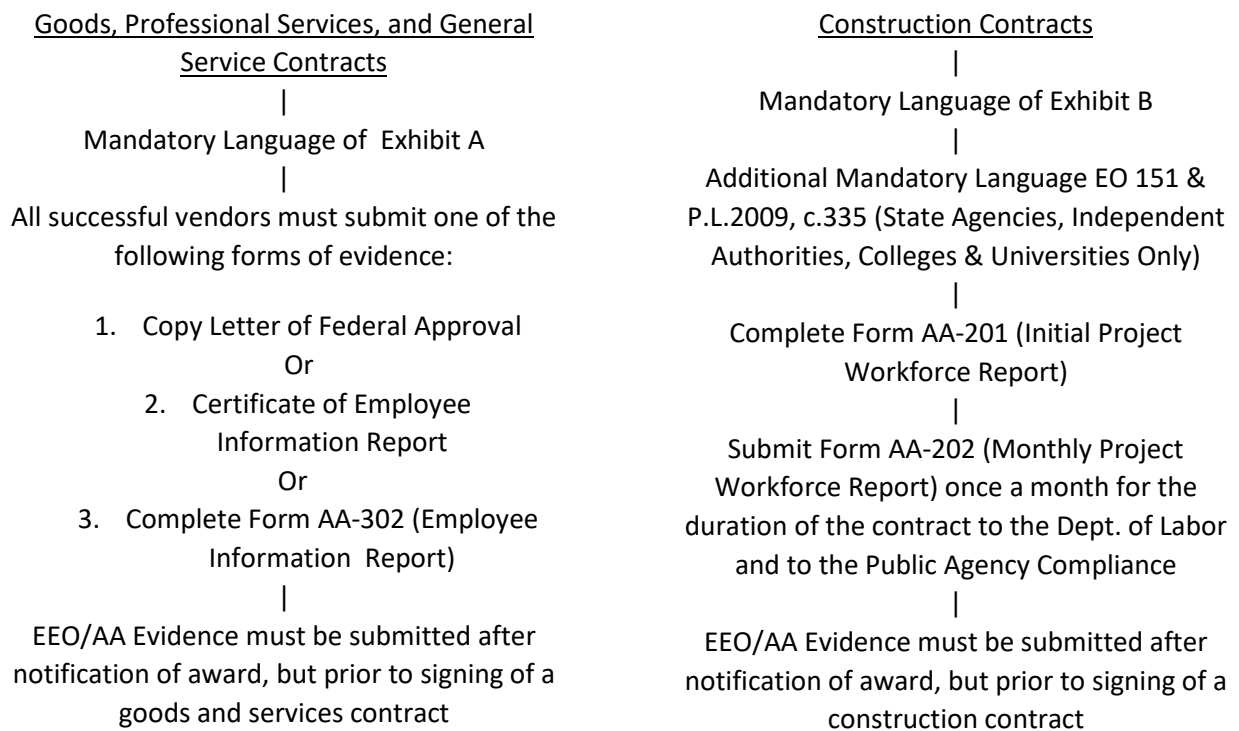

BUSINESS REGISTRATION CERTIFICATE

“Pursuant to the terms of N.J.S.A 52:32-44, all bidders/proposers are required to submit with their bid, proof of valid business registration issued by the Division of Revenue in the Department of Treasure. Failure to submit proof of registration is considered cause for mandatory rejection of bids (a non-waivable defect). No contract shall be entered into by the South Jersey Port Corporation unless the contractor first provides proof of valid business registration. In addition, the successful bidder/proposer is required to receive from any subcontractor it used for services under this contract, proof of valid business registration with an contract with the South Jersey Port Corporation unless the subcontractor first provides proof of valid business registration.”

If you are already registered go to <https://www.state.nj.us/treasury/revenue/busregcert.shtml> to obtain a copy of your Business Registration Certificate.

All question regarding this requirement should be referred to the Division of Revenues
<https://www.state.nj.us/treasury/revenue/revgencode.shtml>

*****PLEASE ATTACH COPY OF YOUR NJ BUSINESS
REGISTRATION CERTIFICATE BELOW*****

NOTICE TO ALL BIDDERS SET-OFF FOR STATE TAX

Please be advised that, pursuant to P.L. 1995, c.159, effective January 1, 1996, and notwithstanding any provision of the law to the contrary, whenever any taxpayer, partnership or S corporation under contract to provide goods or services or construction projects to the State of New Jersey or its agencies or instrumentalities, including the legislative and judicial branches of State government, is entitled to payment for those goods or services at the same time a taxpayer, partner or shareholder of that entity is indebted for any State tax, the Director of the Division of Taxation shall seek to set off that taxpayer's or shareholder's share of the payment due the taxpayer, partnership or S corporation. The amount set off shall not allow for the deduction of any expenses or other deductions which might be attributable to the taxpayer, partner, or shareholder subject to set-off under this act.

The Director of the Division of Taxation shall give notice of the set-off to the taxpayer and provide an opportunity for a hearing within 30 days of such notice under the procedures for protests established under R.S. 54:49-18. No requests for conference, protest, or subsequent appeal to the Tax Court from any protest under this section shall stay the collection of the indebtedness. Interest that may be payable by the State, pursuant to P.L. 1987, c.184 (c. 52:32-32 et seq.), to the taxpayer shall be stayed".

"I HAVE BEEN ADVISED OF THIS NO"ICE"

COMPANY: _____

SIGNATURE: _____

NAME: _____

TITLE: _____

DATE: _____

SOURCE DISCLOSURE FORM

BID SOLICITATION # AND TITLE: _____

VENDOR/BIDDER NAME: _____

The Vendor/Bidder submits this Form in response to a Bid Solicitation issued by the South Jersey Port Corporation, in accordance with the requirements of N.J.S.A. 52:34-13.2.

PART 1

- All services will be performed by the Contractor and Subcontractors in the United States. Skip Part 2.
- Services will be performed by the Contractor and/or Subcontractors outside of the United States.
Complete Part 2.

PART 2

Where services will be performed outside of the United States, please list every country where services will be performed by the Contractor and all Subcontractors. If any of the services cannot be performed within the United States, the Contractor shall state, with specificity, the reasons why the services cannot be performed in the United States. The Director of the South Jersey Port Corporation will review this justification and if deemed sufficient, the Director may seek the Treasurer’s approval.

Name of Contractor / Sub-contractor	Performance Location by Country	Description of Service(s) to be Performed Outside of the U.S.	Reason Why the Service(s) Cannot be Performed in the U.S.

**Attach additional sheets if necessary to describe which service(s), if any, will be performed outside of the U.S. and the reason(s) why the service(s) cannot be performed in the U.S.*

Any changes to the information set forth in this Form during the term of any Contract awarded under the referenced Bid Solicitation or extension thereof shall be immediately reported by the Contractor to the Director of the South Jersey Port Corporation. If during the term of the Contract, the Contractor shifts the location of services outside the United States, without a prior written determination by the Director, the Contractor shall be deemed in breach of Contract, and the Contract will be subject to termination for cause. (cont.)

CERTIFICATION

I, the undersigned, certify that I am authorized to execute this certification on behalf of the Vendor/Bidder, that the foregoing information and any attachments hereto, to the best of my knowledge are true and complete. I acknowledge that the South Jersey Port Corporation (SJPC) is relying on the information contained herein, and that the Vendor/Bidder is under a continuing obligation from the date of this certification through the completion of any Contract(s) with the SJPC to notify the SJPC in writing of any changes to the information contained herein; that I am aware that it is a criminal offense to make a false statement or misrepresentation in this certification. If I do so, I will be subject to criminal prosecution under the law, and it will constitute a material breach of my agreement(s) with the SJPC, permitting the SJPC to declare any contract(s) resulting from this certification to be void and unenforceable.

Signature

Date

Print Name and Title

Code of Ethics for Vendors

EXECUTIVE ORDER # 189

The South Jersey Port Corporation considers the maintenance of public trust and confidence essential to its proper functioning, and accordingly has adopted this vendors' Code of Ethics. Vendors who do business with SJPC must avoid all situation where propriety or financial interests, or opportunity for financial gain, could lead to favored treatment for any organization or individual. Vendors must also avoid circumstances and conduct which may constitute actual wrongdoing, or a conflict of interest, but might nevertheless appear questionable to the general public, this compromising the integrity of SJPC.

This code is based upon the principles established in Executive Order 189 and laws governing the Executive Commission on Ethical Standards. N.J.S.A. 52:13D et seq., which, while not strictly applicable to contractors, provides general guidance in this area. Also, this code has been established pursuant to the authority embodied in N.J.S.A. 27:25A et seq., and for good cause.

This Code of Ethics shall be made part of each Request for Proposal (RFP) promulgated by the SJPC and be attached to every contract and agreement to which the SJPC is a party. It shall be distributed to all parties who presently do business with SJPC and, to the extent feasible, to all those parties anticipated doing business with SJPC.

1. No vendor shall employ any SJPC officer or employee in the business of the vendor or professional activity in which the vendor is involved with the SJPC officer or employee.
2. No vendor shall offer or provide an interest, financial or otherwise, direct, or indirect, in the business of the vendor or professional activity in which the vendor is involved with SJPC officer or employee.
3. No vendor shall cause or influence, or attempt to cause or influence any SJPC officer or employee in his or her official capacity in any manner which might tend to impair the objectivity or independence of judgment of the SJPC official or employee.
4. No vendor shall cause or influence, or attempt to cause influence any SJPC officer or employee to use or attempt to use his or her official position to secure an unwarranted privileges or advantages for that vendor or for any other person.

No vendor shall offer any SJPC officer or employees any gifts or favors, service or other thing of value under circumstances from which it might be reasonably inferred that such gift, service or other thing of value was given or offered for purpose of influencing the recipient in the discharge of his or her official duties. In addition, officers, or employees of the SJPC will not be permitted to accept breakfasts, lunches, dinner, alcoholic beverages, tickets to entertainment and/or sporting events or any other item which could be construed having more than nominal value.

NOTE: This section would permit an SJPC officer or employee to accept food or refreshment of relatively low monetary value provided during the course of a meeting, conference or other

occasion where the employee is proper in attendance (for example – coffee, Danish, tea, or soda served during conference break).

Acceptance of unsolicited advertising or promotional material of nominal value (such as inexpensive pens, pencils, or calendars) would be permitted.

Any questions as to what is or is not acceptable or what constitutes proper conduct for an SJPC officer or employee should be referred to the SJPC's Ethic Liaison Officer or his or her designee.

5. This code is intended to augment, not to replace, existing administrative orders and the current SJPC Code of Ethics.

*Vender is defined as any general contractor, subcontractor, consultant, person, firm, corporation, or organization engaging in seeking to do business with the SJPC.

I certify that I have read and understand the aforementioned "Vendor Code of Ethics of the South Jersey Port Corporation".

Vender: _____

Primary Contact & Title: _____

Signature _____

Date: _____

INFORMATION AND INSTRUCTIONS
For Completing the “Two-Year Chapter 51/Executive Order
333 Vendor Certification and Disclosure of Political
Contributions for Non-Fair and Open Contracts” Form

Background Information

New Jersey law insulates the negotiation and award of State contracts from political contributions that posed a risk of improper influence, purchase of access or the appearance thereof. P.L.2005, c.51, as amended by the Elections Transparency Act, P.L.2023, c.30, codified at N.J.S.A. 19:44A-20.13 to 20.25 (“Chapter 51”) and Executive Order No. 333 (2023).

For Contracts Awarded Pursuant to a Fair and Open Process

Pursuant to P.L.2005, c.51, as amended by the Elections Transparency Act, P.L.2023, c.30, codified at N.J.S.A. 19:44A-20.13 to 20.25 (“Chapter 51”), and Executive Order No. 333 (2023), contracts awarded pursuant to a fair and open process do **not** require a certification or disclosure of any solicitation or contribution of money, or pledge of contribution, including in-kind contributions.

For Contracts Awarded Pursuant to a Non-Fair and Open Process

Pursuant to P.L.2005, c.51, as amended by the Elections Transparency Act, P.L.2023, c.30, codified at N.J.S.A. 19:44A-20.13 to 20.25 (“Chapter 51”), and Executive Order No. 333 (2023), the State shall not enter into a Contract to procure services or any material, supplies or equipment, or to acquire, sell, or lease any land or building from any Business Entity, where the value of the transaction exceeds \$17,500, if that Business Entity has solicited or made any contribution of money, or pledge of contribution, including in-kind contributions, to a Continuing Political Committee or to a candidate committee and/or election fund of any candidate for or holder of the public office of Governor during certain specified time periods.

Definitions:

A “fair and open process” means, at a minimum, that the contract shall be: publicly advertised in newspapers or on the Internet website maintained by the public entity in sufficient time to give notice in advance of the contract; awarded under a process that provides for public solicitation of proposals or qualifications and awarded and disclosed under criteria established in writing by the public entity prior to the solicitation of proposals or qualifications; and publicly opened and announced when awarded. A contract awarded under a process that includes public bidding or competitive contracting pursuant to State contracts law shall constitute a fair and open process. N.J.S.A. 19:44A-20.23 (P.L.2005, c.51, rev. P.L.2023, c.30).

A “Continuing Political Committee” means any political organization (a) organized under section 527 of the Internal Revenue Code; and (b) consisting of any group of two or more persons acting jointly, or any corporation, partnership, or any other incorporated or unincorporated association, including a political club, political action committee, civic association or other organization, which in any calendar year contributes or expects to contribute at least \$5,500 to the aid or promotion of the candidacy of an individual, or of the candidacies of individuals, for elective public office, or the passage or defeat of a public question or public questions, and which may be expected to make contributions toward such aid or promotion or passage or defeat during a subsequent election, provided that the group, corporation, partnership, association or other organization has been determined to be a continuing political committee by the New Jersey Election Law Enforcement Commission under N.J.S.A.19:44A-8(b)(8). A Continuing Political Committee does not include a “political party committee,” a “legislative leadership committee,” or an “independent expenditure committee,” as defined in N.J.S.A. 19:44A-3.

Two-Year Certification Process

Upon approval by the State Chapter 51 Review Unit, the Certification and Disclosure of Political Contributions form **for Non-Fair and Open Contracts** is valid for a two (2) year period. Thus, if a Business Entity and/or vendor receives approval on January 1, 2022, the certification expiration date would be December 31, 2023. Any change in the Business Entity’s ownership status and/or political contributions during the two-year period will require the submission of new Chapter 51 forms to the contracting State Agency. **Please note that it is the Business Entity’s responsibility to file new forms with the State**

should these changes occur.

State Agency Instructions

Prior to the awarding of a contract, the State Agency should first use NJSTART (<https://www.njstart.gov/bsol/>) to check the status of a Business Entity's Chapter 51 certification before contacting the Review Unit's mailbox at CD134@treas.nj.gov. If the State Agency does not find any Chapter 51 Certification information in NJSTART and/or the Business Entity is not registered in NJSTART, then the State Agency should send an e-mail to CD134@treas.nj.gov to verify the certification status of the Business Entity. If the response is that the Business Entity is NOT within an approved two-year period, then forms must be obtained from the Business Entity and forwarded for review. If the response is that the Business Entity is within an approved two-year period, then the response so stating should be placed with the bid/contract documentation for the subject project.

Instructions for Completing the Form

"For State Use Only" box

This box/section should **only** be filled out by the contracting State agency.

The contracting State agency must check the box indicating whether this is a fair and open contract. Please note that if the answer is **YES**, the **Chapter 51 form is not required** and should not be submitted as per the Elections Transparency Act, P.L.2023, c.30, codified at N.J.S.A. 19:44A-20.13 to 20.25 ("Chapter 51") and Executive Order No. 333 (2023).

NOTE: Parts 1, 2 and 3 of the form should be filled out the Business Entity.

Part 1: BUSINESS ENTITY INFORMATION

Business Name – Enter the full legal name of the Business Entity, including trade name if applicable.

Address, City, State, Zip and Phone Number – Enter the Business Entity's street address, city, state, zip code and telephone number.

Vendor Email – Enter the Business Entity's primary email address.

Vendor FEIN – Please enter the Business Entity's Federal Employment Identification Number.

Business Type – Check the appropriate box that represents the Business Entity's type of business formation.

Listing of officers, shareholders, partners or members – Based on the box checked for the business type, provide the corresponding information. (A complete list must be provided.)

Part 2: DISCLOSURE OF CONTRIBUTIONS

Read the two (2) types of political contributions that require disclosure and, if applicable, provide the recipient's information.

Name of Recipient – Enter the full legal name of the recipient.

Address of Recipient – Enter the recipient's street address.

Date of Contribution – Indicate the date the contribution was given.

Amount of Contribution – Enter the dollar amount of the contribution.

Type of Contribution – Select the type of contribution from the examples given.

Contributor's Name – Enter the full name of the contributor.

Relationship of the Contributor to the Vendor – Indicate the relationship of the contributor to the Business Entity. (e.g., officer or shareholder of the company, partner, member, parent company of the vendor, subsidiary of the vendor, etc.)

NOTE: If form is being completed electronically, click "Add a Contribution" to enter additional contributions. Otherwise, please attach additional pages as necessary.

Check the box under the recipient information within Part 2 if no reportable contributions have been solicited or made by the Business Entity. **This box must be checked if there are no contributions to report.**

Part 3: CERTIFICATION

Check Box A if the representative completing the Certification and Disclosure form is doing so on behalf of the Business Entity and all individuals and/or entities whose contributions are attributable to the Business Entity. No additional Certification and Disclosure forms are required if BOX A is checked.

Check Box B if the representative completing the Certification and Disclosure form is doing so on behalf of the Business Entity and all individuals and/or entities whose contributions are attributable to the Business Entity with the exception of those individuals and/or entities that submit their own separate form. For example, the representative is not signing on behalf of the vice president of a corporation, but all others. The vice president completes a separate Certification and Disclosure form. **Additional Certification and Disclosure forms are required from those individuals and/or entities that the representative is not signing on behalf of and are included with the business entity's submittal.**

Check Box C if the representative completing the Certification and Disclosure form is doing so on behalf of the Business Entity only. Additional Certification and Disclosure forms are required from all individuals and/or entities whose contributions are attributable to the Business Entity and must be included with the Business Entity submittal.

Check Box D when a sole proprietor is completing the Certification and Disclosure form or when an individual or entity whose contributions are attributable to the Business Entity is completing a separate Certification and Disclosure form.

Read the five statements of certification prior to signing.

The representative authorized to complete the Certification and Disclosure form must sign and print her/his name, title or position and enter the date.

State Agency Procedure for Submitting Form(s)

The State Agency should submit the completed and signed Two-Year Vendor Certification and Disclosure forms either electronically to: cd134@treas.nj.gov or regular mail at: Chapter 51 Review Unit, P.O. Box 230, 33 West State Street, Trenton, NJ 08625-0230. Original forms should remain with the State Agency and copies should be sent to the Chapter 51 Review Unit.

Business Entity Procedure for Submitting Form(s)

- The Business Entity should return this form to the contracting State Agency.
- The Business Entity should also submit the Certification and Disclosure form directly to the Chapter 51 review Unit only when:
- The Business Entity is approaching its two-year certification expiration date and is seeking certification renewal;
- The Business Entity had a change in its ownership structure; OR
- The Business Entity made any contributions during the period in which its last two-year certification was in effect, or during the term of a contract with a State Agency.

Questions & Information

Questions regarding Public Law 2005, Chapter 51 (N.J.S.A. 19:44A-20.13) as amended by the Elections Transparency Act, P.L.2023, c.30, codified at N.J.S.A. 19:44A-20.13 to 20.25 ("Chapter 51") and Executive Order No. 333 (2023) or may be submitted electronically through the Division of Purchase and Property website at: <https://www.state.nj.us/treas/purchase/eo333questions.shtml>.

Reference materials and forms are posted on the Political Contributions Compliance website at: <https://www.state.nj.us/treasury/purchase/execorder333.shtml>.



Two-Year Chapter 51 /Executive Order 333 Vendor Certification and Disclosure of Political Contributions for Non-Fair and Open Contracts

FOR STATE USE ONLY

Solicitation, RFP, or Contract No. _____ Award Amount _____

Is the contract being awarded pursuant to a "fair and open process" pursuant to P.L.2023, c.30? Yes No

Description of Services _____

State Agency Name _____ Contact Person _____

Phone Number _____ Contact Email _____

Check if the Contract / Agreement is Being Funded Using FHWA Funds

**Please check if requesting
recertification**

Part 1: Business Entity Information

Full Legal Business Name _____
(Including trade name if applicable)

Address _____

City _____ State _____ Zip _____ Phone _____

Vendor Email _____ Vendor FEIN (SS# if sole proprietor/natural person) _____

**Check off the business type and list below the required information for the type of business selected.
MUST BE COMPLETED IN FULL**

- Corporation: LIST ALL OFFICERS and any 10% and greater shareholder (If the corporation only has one officer, please write "sole officer" after the officer's name.)
- Professional Corporation: LIST ALL OFFICERS and ALL SHAREHOLDERS
- Partnership: LIST ALL PARTNERS with any equity interest
- Limited Liability Company: LIST ALL MEMBERS with any equity interest
- Sole Proprietor

Note: "Officers" means President, Vice President with senior management responsibility, Secretary, Treasurer, Chief Executive Officer or Chief Financial Officer of a corporation, or any person routinely performing such functions for a corporation.

Also Note: "N/A will not be accepted as a valid response. Where applicable, indicate "None."

All Officers of a Corporation or PC

**10% and greater shareholders of a corporation
or all shareholders of a PC**

All Equity partners of a Partnership

All Equity members of a LLC

If you need additional space for listing of Officers, Shareholders, Partners or Members, please attach separate page.

Part 2: Disclosure of Contributions by the Business Entity or any person or entity whose contributions are attributable to the Business Entity.

1. Report below all contributions solicited or made during the 4 years immediately preceding the commencement of negotiations or submission of a proposal to any:

Political organization organized under Section 527 of the Internal Revenue Code and which also meets the definition of a continuing political committee as defined in N.J.S.A. 19:44A-3(n).

2. Report below all contributions solicited or made during the 5 ½ years immediately preceding the commencement of negotiations or submission of a proposal to any:

Candidate Committee for or Election Fund of any Gubernatorial candidate.

Full Legal Name of Recipient _____ Address of Recipient _____ Date of Contribution _____ Amount of Contribution _____ Type of Contribution (i.e. currency, check, loan, in-kind) _____ Contributor Name _____ Relationship of Contributor to the Vendor _____ If this form is not being completed electronically, please attach additional contributions on separate page. <input type="button" value="Remove Contribution"/> Click the "Add a Contribution" tab to enter additional contributions.
Full Legal Name of Recipient _____ Address of Recipient _____ Date of Contribution _____ Amount of Contribution _____ Type of Contribution (i.e. currency, check, loan, in-kind) _____ Contributor Name _____ Relationship of Contributor to the Vendor _____ If this form is not being completed electronically, please attach additional contributions on separate page. <input type="button" value="Remove Contribution"/> Click the "Add a Contribution" tab to enter additional contributions.
<input type="button" value="Add a Contribution"/>

Check this box only if no political contributions have been solicited or made by the business entity or any person or entity whose contributions are attributable to the business entity.

Part 3: Certification (Check one box only)

- (A) I am certifying on behalf of the business entity and all individuals and/or entities whose contributions are attributable to the business entity as listed on Page 1 under **Part 1: Vendor Information**.
- (B) I am certifying on behalf of the business entity and all individuals and/or entities whose contributions are attributable to the business entity as listed on Page 1 under **Part 1: Vendor Information**, except for the individuals and/or entities who are submitting separate Certification and Disclosure forms which are included with this submittal.
- (C) I am certifying on behalf of the business entity only; any remaining persons or entities whose contributions are attributable to the business entity (as listed on Page 1) have completed separate Certification and Disclosure forms which are included with this submittal.
- (D) I am certifying as an individual or entity whose contributions are attributable to the business entity.

I hereby certify as follows:

- 1. I have read the Information and Instructions accompanying this form prior to completing the certification on behalf of the business entity.**
- 2. All reportable contributions made by or attributable to the business entity have been listed above.**

3. The business entity has not knowingly solicited or made any contribution of money, pledge of contribution, including in-kind contributions, that would bar the award of a contract to the business entity unless otherwise disclosed above:

- a) Within the 18 months immediately preceding the commencement of negotiations or submission of a proposal for the contract or agreement to a candidate committee or election fund of any candidate for the public office of Governor or election fund of holder of public office of Governor.
- b) During the term of office of the current Governor to a candidate committee or election fund of a holder of the public office of Governor.
- c) Within the 18 months immediately preceding the last day of the sitting Governor’s first term of office to a candidate committee or election fund of the incumbent Governor.

4. During the term During the term of the contract/agreement the business entity has a continuing responsibility to report, by submitting a new Certification and Disclosure form, any contribution it solicits or makes to any candidate committee or election fund of any candidate or holder of the public office of Governor.

The business entity further acknowledges that contributions solicited or made during the term of the contract/agreement may be determined to be a material breach of the contract/agreement.

5. During the two-year certification period the business entity will report any changes in its ownership structure (including the appointment of an officer within a corporation) by submitting a new Certification and Disclosure form indicating the new owner(s) and reporting said owner(s) contributions.

I certify that the foregoing statements in Parts 1, 2 and 3 are true. I am aware that if any of the statements are willfully false, I may be subject to punishment.

Signed Name _____ Print Name _____
 Title/Position _____ Date _____

Procedure for Submitting Form(s)

The contracting State Agency should submit this form to the Chapter 51 Review Unit when it has been required as part of a contracting process. The contracting State Agency should submit a copy of the completed and signed form(s), to the Chapter 51 Unit and retain the original for their records.

The Business Entity should return this form to the contracting State Agency. The Business Entity can submit this form directly to the Chapter 51 Review Unit only when it:

- Is approaching its two-year certification expiration date and wishes to renew certification;
- Had a change in ownership structure; OR
- Made any contributions during the period in which its last two-year certification was in effect, or during the term of a contract with a State Agency.

Forms should be submitted either electronically to: cd134@treas.nj.gov , or regular mail at: Chapter 51 Review Unit, P.O. Box 230, 33 West State Street, Trenton, NJ 08625.

State of New Jersey
Executive Order #151

Governor Jon S. Corzine

WHEREAS, New Jersey is one of the most racially, culturally, and ethnically diverse states in the United States, and this diversity is reflected in the leaders and owners of its businesses, in the leaders and members of the labor movement, and in the employees in every segment of the workforce; and

WHEREAS, the State's business community includes multi-national enterprises, industrial, commercial, and small business sectors; and

WHEREAS, the State's thousands of small businesses, each with fewer than 100 employees, together generate almost 40% of the jobs in the State; and

WHEREAS, small, minority, and women-owned business enterprises have historically been underrepresented in the receipt of State contract awards; and

WHEREAS, the State's workforce provides New Jersey's multinational enterprises, its industrial, commercial, and small business sectors, and its public and not-for-profit sectors with highly educated, highly skilled, and highly motivated employees, who contribute to the prosperity of the State while supporting their families; and

WHEREAS, in response to the current national recession, the United States Congress enacted the American Recovery and Reinvestment Act of 2009 (ARRA), which will increase federal spending at the State and local levels by approximately \$10 billion, and will fully fund certain work in the State, and partially fund other State projects; and

WHEREAS, given the recession and unemployment levels in New Jersey, it is imperative that every sector of the economy be offered the opportunity to benefit from the federal economic recovery funds and the State's own spending; and

WHEREAS, many of the State's businesses have significant public construction contracts and other contracts to provide goods or services to government and many others would like the opportunity to compete for these contracts to expand their businesses while serving the public; and

WHEREAS, residents of the State of New Jersey deserve a government that provides equal opportunity for all contractors to compete to submit winning bids on public contracts; and

WHEREAS, residents of the State of New Jersey, especially during these difficult economic times, deserve a government that does everything it can to expand job opportunities, particularly for men and women who are entering the workforce, who have experienced difficulties entering the workforce, or who have recently become unemployed or underemployed; and

WHEREAS, the State created an internet site, <http://www.recovery.nj.gov>, which outlines the allocation of New Jersey's share of economic recovery funds under the ARRA; and

WHEREAS, to spend ARRA funds transparently and ensure that those seeking work have a fair chance to obtain ARRA-funded employment, State agencies and entities should be required to post all State and

ARRA-funded jobs on the State Job Bank internet site, <http://NJ.gov/JobCentralNJ>, to allow New Jersey residents to identify these employment opportunities; and

WHEREAS, the State must procure its construction services, goods, and other services as efficiently as possible, with transparency in the processing, selection, and awarding of public contracts; and

WHEREAS, robust competition for public contracts ensures that the government of the State of New Jersey obtains the construction services, goods, and other services it needs to perform its vital functions with maximum cost effectiveness; and

WHEREAS, broad and sustained efforts to notify all potential bidders of opportunities to contract with government should be encouraged to promote competition for public contracts, thus benefiting the public fisc; and

WHEREAS, the State of New Jersey commissioned the State of New Jersey Construction Services Disparity Study 2000 – 2002 (October 2005) and the State of New Jersey Disparity Study of Procurement in Professional Services, Other Services, and Goods and Commodities (June 2005), and both studies documented significant disparities between the firms ready, willing, and able to do business with the State, and those firms actually awarded contracts by State departments, agencies, authorities, colleges, and universities, as a result of which this Administration created through Executive Order No. 34 (2006) the Division of Minority and Women Business Development (“Division of M/W Business Development”); and

WHEREAS, Executive Order No. 34 charged the Director of the Division of M/W Business Development with monitoring programs to increase the participation of minority and women-owned businesses in the State’s purchasing and procurement processes; and

WHEREAS, since its inception, the Division of M/W Business Development, working with the Department of the Treasury’s Office of Supplier Diversity (“OSD”), has identified strategies to increase the number of small and minority and women-owned businesses interested in and eligible to benefit from state procurement activity; and

WHEREAS, the Division of M/W Business Development and OSD have increased outreach to and expanded the ability of these businesses to fulfill bid requirements for state contracts; and

WHEREAS, the Division of Public Contracts Equal Employment Opportunity Compliance in the Department of the Treasury (Division of Contract Compliance) monitors the employment of women and minorities with businesses that contract with government in an effort to ensure that contractors and vendors make good faith efforts to hire minorities and women in accordance with targeted goals based on the United States Census’ workforce availability statistics;

NOW, THEREFORE, I, JON S. CORZINE, Governor of the State of New Jersey, by virtue of the authority vested in me by the Constitution and by the Statutes of this State, do hereby ORDER and DIRECT:

1. All members of the public should be afforded the opportunity to benefit from the federal economic recovery funds and associated state spending, and in particular, this Administration re-affirms the State’s commitment, expressed in statute and regulation, that every public contract, whether for construction services, goods, or other services, shall provide equal employment opportunity for women and minorities.

2. The Commissioners of the Departments of Community Affairs, Education, Environmental Protection, and Transportation; the President of the Board of Public Utilities; and the executive directors of the Schools Development Authority and the Economic Development Authority are directed to meet with members of the Governor's office, the Department of the Treasury, and representatives of the United States Department of Labor's Office of Federal Contract Compliance Programs (OFCCP) to ensure that those departments receiving the bulk of federal economic recovery funds will provide the OFCCP their complete cooperation in complying with its mandates.

3. The Division of Contract Compliance shall be the entity within the Executive Branch responsible for determining whether minorities and women have been offered a fair opportunity for employment on State contracts. Executive branch departments and agencies, independent authorities, and State colleges and universities are directed to cooperate fully with the Division of Contract Compliance's enforcement efforts, consistent with law, and to award public contracts only to those businesses that agree to comply with equal employment opportunity and affirmative action requirements.

4. The Division of Contract Compliance shall work cooperatively with the OFCCP, including sharing its workforce data to the maximum extent permitted by law, to assist the OFCCP in its enforcement efforts.

5. When not restricted by any other State or federal law, the Division of Contract Compliance shall determine whether each of the State entities whose performance it monitors (the "Reporting Agencies" listed in Appendix A to this Order) properly allocated and released to the Department of Labor and Workforce Development, as authorized by law, one-half of one percent of the total cost of a construction contract of \$1,000,000 or more, to be used by the department for the New Jersey Builders Utilization Initiative for Labor Diversity program to train minorities and women for employment in construction trades. This provision shall apply to those construction contracts where the funding for the contract consists entirely of appropriated funds or a combination of funds from appropriated funds and other sources.

6. As a result of the aforementioned significant disparities in employment of minorities and women on construction sites and within the construction trades, all construction contracts entered into and funded, in whole or in part, by the State shall include mandatory EEO/AA contract language (in the form of Appendix B to this Order) that requires contractors to make a good faith effort to recruit and employ minorities and women as required by provisions of the Administrative Code, including but not limited to N.J.A.C. 17:27-3.6 to 3.8, and 17:27-7.3 and 7.4. In addition to the language set forth in Appendix B, such construction contracts shall contain the contractual language as required by N.J.A.C. 17-27-3.6, 3.7, and 3.8. As to the portion of each contract that is State funded, the language of the contract shall provide, consistent with Appendix B, that payment may be withheld for failure of the contractor to demonstrate to the satisfaction of the Reporting Agency that the required good faith effort was made. Failure of a contractor to satisfy the good faith effort requirement of its contract may also subject it to assessments imposed pursuant to findings of the Division of Contract Compliance in the Department of the Treasury, in accordance with N.J.A.C. 17:27-10.

7. Except as described in subparagraphs (a) and (b) of this paragraph, each Executive Branch agency that is a recipient of federal economic recovery funds pursuant to ARRA shall include in any contract, grant, or agreement funded in whole or in part with ARRA funds a clause requiring subrecipients, contractors, subcontractors, local education agencies, and vendors to post all job openings created pursuant to the contract, grant, or agreement on the State's Job Bank at least 14 days before hiring is to commence. The clause shall state: "Since the funds supporting this contract, grant, or agreement are provided through the American Recovery and Reinvestment Act of 2009 (ARRA), the subrecipient, contractor, subcontractor, local education agency, or vendor will post any jobs that it creates or seeks to fill as a result of this

contract, grant, or agreement. The subrecipient, contractor, subcontractor, local education agency, or vendor will post jobs to the New Jersey State Job Bank by submitting a job order using the form available at <http://www.NJ.gov/JobCentralNJ>, notwithstanding any other posting the subrecipient, contractor, subcontractor, local education agency, or vendor might make. Any advertisements posted by the subrecipient, contractor, subcontractor, local education agency, or vendor for positions pursuant to this contract, grant, or agreement must indicate that the position is funded with ARRA funds."

a. Posting shall not be required where the employer intends to fill the job opening with a present employee, a laid-off former employee, or a job candidate from a previous recruitment, where pre-existing, legally binding collective bargaining agreements provide otherwise, or where an exception has been granted to the Reporting Agency by the Department of Labor and Workforce Development.

b. Nothing in this Order shall be interpreted to require the employment of apprentices if such employment may result in the displacement of journey workers employed by any employer, contractor, or subcontractor.

8. All local government entities and local education agencies that have received or will receive directly from a federal agency federal economic recovery funds are strongly encouraged to require their contractors and subcontractors to post job openings on the State's Job Bank at least 14 days before hiring is to commence. Moreover, all New Jersey employers that enter into contracts funded with ARRA funds received by a local government entity or a local education agency directly from a federal agency are likewise strongly encouraged to post job openings created pursuant to the ARRA.

9. The Division of M/W Business Development shall send to the Reporting Agencies the contractual language set forth in Appendix C of this Order. Provisions of this contractual language have been shown to have a significant impact on (a) increasing the number of small and minority and women-owned businesses aware of contracting opportunities with the State and (b) increasing the number of such businesses competing for contracts with the State or subcontracts with entities contracting with the State. The Division of M/W Business Development shall work with each Reporting Agency to ensure the reporting of and ensure compliance with contract-specific contracting and subcontracting goals for the Reporting Agency that are consistent with the availability percentages set forth in Appendix D. These goals should incorporate good faith effort requirements and should be adjusted annually, consistent with the availability of minority and women-owned businesses for which significant disparities in utilization have been demonstrated in each business category.

10. Each Reporting Agency shall:

a. Inform the Division of M/W Business Development of contracting opportunities at the same time that it advertises or otherwise posts public notices of such opportunities, via consistent and timely upload of all-inclusive information to the bid opportunities database services managed by the Division of M/W Business Development. All pre-bid requirements shall be prominently advertised at the time of uploading to the Division of M/W Business Development databases;

b. Actively and regularly use the databases and other on-line services managed and operated by the Division of M/W Business Development to identify additional potential bidders. Because these databases and on-line services identify minority and women-owned businesses known to and registered or certified with the Division of M/W Business Development, the ongoing use of these resources by buyers, procurement agents, and other purchasing staff shall be closely monitored by the Reporting Agency's senior management;

c. Contact the businesses identified in the Division of M/W Business Development's databases and on-line services to provide them with notice of the contracting opportunities available through the Reporting Agency; and

d. Report to the Division of M/W Business Development all payments and awards prime contractors have issued to subcontractors, identifying payments and awards to minority and women-owned businesses on at least a quarterly basis.

11. To the maximum extent practicable, and when not restricted by any other State or federal law, each Reporting Agency shall incorporate the substance of the contractual language set forth in Appendix C into its contracts, while continuing to follow the particular State and federal laws and regulations governing its contracting and procurement practices.

12. Each Reporting Agency shall, where substitution of subcontractors or sub-consultants is permitted, promulgate policies governing the circumstances under which contractors or consultants may substitute subcontractors or sub-consultants named in bid proposals or otherwise identified as small or women or minority-owned business subcontractors, sub-consultants, or vendors ("Substitution Policies"). The Substitution Policies shall provide that:

a. The contractor or consultant must notify and obtain approval from a small or women or minority-owned business subcontractor, sub-consultant, or vendor ("SMWBE contractor") before including that contractor in a bid proposal or similar contract-related submission;

b. The contractor or consultant must notify and obtain authorization from the Reporting Agency before it substitutes a SMWBE contractor named in a bid proposal or other contract-related submission; and

c. If the substitution is approved, the contractor or consultant shall make a good faith effort to utilize another SMWBE contractor in place of the previous SMWBE contractor.

13. Each Reporting Agency shall report to the Division of M/W Business Development when it has incorporated the language set forth in Appendix C in its contracts. It shall also report to the Division of M/W Business Development when it has adopted its Substitution Policy, where such policy is permitted. The Division of M/W Business Development shall report on the number of Reporting Agencies that have modified their contracts and adopted a Substitution Policy at three month intervals until all of the Reporting Agencies have completed incorporation of the contractual language set forth in Appendix C and, where legally permitted, adoption of the Substitution Policy.

14. Nothing in this Order shall modify existing law, state or federal, or authorize a Reporting Agency to amend, modify, or otherwise alter pre-existing legal obligations. Further, this Order shall be interpreted consistently with the ARRA, and the federal regulations and guidelines governing its implementation, and in the event of a conflict between this Order and federal law governing ARRA, the Order shall be interpreted to comply with federal law.

15. Within 90 days of the date of this Order, the Division of M/W Business Development shall prepare a Contracting Guide identifying the management practices that have the greatest success in: (a) increasing the number of small and minority and women-owned businesses made aware of contracting opportunities with the State; and (b) increasing the number of such businesses competing for contracts with the state or subcontracts with entities contracting with the state. As soon as practicable thereafter, the Division of M/W Business Development shall distribute the Contracting Guide to the Reporting Agencies.

16. As soon as practicable after its receipt of the Contracting Guide, each Reporting Agency shall implement those provisions that it views as most likely to have the greatest impact in increasing contracting opportunities for small and minority and women-owned businesses.

17. Within one year and ninety days of the effective date of this Order, the Division of M/W Business Development and the Division of Contract Compliance shall each prepare a report describing the Reporting Agencies' implementation of this Order. The Division of M/W Business Development and the Division of Contract Compliance each shall prepare a second report within one year of issuing its first report.

18. The Department of Labor and Workforce Development shall work together with all other Reporting Agencies that will receive ARRA funding and with the representatives of the United States Environmental Protection Agency, the Federal Departments of Labor, Energy, Transportation, and Housing and Urban Development, and any other federal agencies distributing ARRA funds to:

- a. Coordinate with labor unions that will aggressively recruit minorities and women for apprenticeships and training opportunities;
- b. Increase outreach to and enrollment of minorities and women in apprenticeship, training, and related programs; and
- c. Ensure that, to the greatest extent possible under the law, minorities and women apprentices and trainees are working on State and ARRA-funded work sites.

19. The Department of the Treasury and other departments, agencies, and independent authorities shall, consistent with law, take steps to increase their engagement of small, minority, or women-owned or controlled banks and credit unions to meet their financial service's needs.

20. This Order shall take effect immediately.

GIVEN, under my hand and seal thi^s 28th day of August Two Thousand and Nine, and of the Independence of the United States, the Two Hundred and Thirty-Fourth.

/s/ Jon S. Corzine

Governor

[seal]

Attest:

/s/ Kay Walcott-Henderson

First Assistant Chief Counsel

APPENDIX A**LIST OF REPORTING AGENCIES**

Board of Public Utility Commissioners
Casino Control Commission
Casino Reinvestment Development Authority
Commission on Higher Education
Commission on Science & Technology
Council on Affordable Housing
Department of Agriculture
Department of Military & Veterans' Affairs
Department of Banking & Insurance
Department of Children & Families
Department of Community Affairs
Department of Corrections
Department of Education
Department of Environmental Protection
Department of Health and Senior Services
Department of Human Services
Department of Labor and Workforce Development
Department of Law & Public Safety
Department of Public Advocate
Department of State
Department of Transportation
Department of the Treasury
Division of Property Management and Construction
Election Law Enforcement Commission
Fort Monmouth Economic Revitalization Planning Authority
Garden State Preservation Trust
Higher Education Student Assistance Authority
Kean University
Legalized Games of Chance Control Commission
Montclair State University
Motion Picture Commission
Motor Vehicle Commission
New Jersey City University
New Jersey Cultural Trust
New Jersey Institute of Technology
New Jersey Transit
NJ Building Authority
NJ Economic Development Authority
NJ Educational Facilities Authority
NJ Environmental Infrastructure Trust
NJ Health Care Facilities Financing Authority
NJ Highlands Council
NJ Housing & Mortgage Finance Agency
NJ Maritime Pilot and Docking Pilot Commission
NJ Meadowlands Commission
NJ Pinelands Commission

NJ Public Television & Radio (NJN) NJ Racing Commission NJ Redevelopment Authority
NJ Schools Development Authority
NJ Sports & Exposition Authority
NJ State Museum
NJ Turnpike Authority
NJ Water Supply Authority
North Jersey Transportation Planning Authority
North Jersey District Water Supply Commission
Office of Homeland Security
Office of Information Technology
Office of the Child Advocate
Office of the Inspector General
Office of the Public Defender
Ramapo College
Rowan University
Rutgers University
South Jersey Port Corporation
South Jersey Transportation Authority
South Jersey Transportation Planning Organization
State Agriculture Development Committee
State Economic Recovery Board For Camden
State Ethics Commission
State Employment & Training Commission
State Lottery Commission
Stockton College
The College of New Jersey
Thomas Edison State College
Transportation Trust Fund Authority
University of Medicine & Dentistry of New Jersey
William Paterson University

APPENDIX B

It is the policy of the South Jersey Port Corporation that its contracts should create a workforce that reflects the diversity of the State of New Jersey. Therefore, contractors engaged by the South Jersey Port Corporation to perform under a construction contract shall put forth a good faith effort to engage in recruitment and employment practices that further the goal of fostering equal opportunities to minorities and women.

The contractor must demonstrate to the South Jersey Port Corporation's satisfaction that a good faith effort was made to ensure that minorities and women have been afforded equal opportunity to gain employment under the South Jersey Port Corporation's contract with the contractor. Payment may be withheld from a contractor's contract for failure to comply with these provisions.

Evidence of a "good faith effort" includes, but is not limited to:

1. The Contractor shall recruit prospective employees through the State Job bank website, managed by the Department of Labor and Workforce Development, available online at <http://NJ.gov/JobCentralNJ>.
2. The Contractor shall keep specific records of its efforts, including records of all individuals interviewed and hired, including the specific numbers of minorities and women.
3. The Contractor shall actively solicit and shall provide the South Jersey Port Corporation with proof of solicitations for employment, including but not limited to advertisements in general circulation media, professional service publications and electronic media.
4. The Contractor shall provide evidence of efforts described at 2 above to the South Jersey Port Corporation no less frequently than once every 12 months.
5. The Contractor shall comply with the requirements set forth at N.J.A.C. 17:27.

APPENDIX C

It is the policy of the South Jersey Port Corporation that small businesses (each a “small business enterprise” or “SBE”), as determined and defined by the State of New Jersey, Division of Minority and Women Business Development (“Division”) and the New Jersey Department of the Treasury (“Treasury”) in N.J.A.C. 17:14 et seq. or other application regulation, should have the opportunity to participate in South Jersey Port Corporation Contracts.

To the extent the Firm engages subcontractors or sub-consultants to perform Services for the South Jersey Port Corporation pursuant to this Contract, the Firm must demonstrate to the South Jersey Port Corporation’s satisfaction that a good faith effort was made to utilize subcontractors and sub-consultants who are registered with the Division as SBEs. Furthermore, the South Jersey Port Corporation shall be evaluated quarterly by the Division, based on its attainment of the Participation Goals set forth in the State of New Jersey Construction Services Disparity Study (October 2005) and the State of New Jersey Disparity Study of Procurement in Professional Services, Other Services, and Goods and Commodities (June, 2005). (These participation goals are set forth below.)

Evidence of a “good faith effort” includes, but is not limited to:

1. The Firm shall request listings of SBEs from the Division (609) 292-2146 and/or the South Jersey Port Corporation and attempt to contact same.
2. The Firm shall keep specific records of its efforts, including records of all requests made to the Division, the names of SBEs contacted, and the means and results of such contacts, including without limitation receipts from certified mail and telephone records.
3. The Firm shall actively solicit and shall provide the South Jersey Port Corporation with proof of solicitations of SBEs for the provision of Services, including advertisements in general circulation media, professional service publications and small business, minority-owned business or women-owned business focus media.
4. The Firm shall provide evidence of efforts made to identify categories of Services capable of being performed by SBEs.
5. The Firm shall provide all potential subcontractors and sub-consultants that the Firm has contacted pursuant to 2 or 3 above with detailed information regarding the scope of work of the subject contract.
6. The Firm shall provide evidence of efforts made to use the goods and/or services of available community organizations, consultant groups, and local, State, and federal agencies that provide assistance in the recruitment and placement of SBEs.

Furthermore, the Firm shall submit proof of its subcontractors’ and/or sub-consultants’ SBE registrations on the form attached as Exhibit __, and shall complete such other forms as may be required by the South Jersey Port Corporation for State reporting as to participation.

Participation Goals

1. Construction Services Contracts/Subcontracts (including new construction and renovations, except routine building maintenance; residential and non-residential building construction; heavy construction, such as streets, roads and bridges; and special trade construction, such as fencing, HVAC, paving and electrical).

(a) State Agencies/Authorities/Commissions

African Americans -- 6.3%
 Asian Americans -- 4.34%

(b) State Colleges and Universities

African Americans -- 6.3%
 Asian Americans -- 4.34%
 Caucasian Females -- 12.67%

2. Construction-Related Services Contracts/Subcontracts (including design services, such as architectural, engineering and construction management services, that are performed as part of a construction project).

State Colleges and Universities

African Americans -- 4.51%
 Asian Americans -- 7.11%
 Hispanics -- 4.

3. Professional Services (with the exception of those professional services deemed to be construction-related, all services that are of a professional nature and requiring special licensing, education degrees and/or very highly specialized expertise, including accounting and financial services, advertising services, laboratory testing services; legal services; management consulting services; technical services and training).

State Agencies/Authorities/Commissions/Colleges and Universities

African Americans -- 2.47%
 Asian Americans -- 1.47%
 Hispanics -- 1.1%
 Native Americans -- 0.07%
 Caucasian Females -- 3.

4. Other Services (any service that is labor-intensive and neither professional nor construction-related, including, but not limited to equipment rental; janitorial and maintenance services; landfill services; laundry and dry cleaning; maintenance and repairs; printing; real property services; security services; special department supplies; subsidy, care and support; telecommunications; and temporary help).

State Agencies/Authorities/Commissions/Colleges and Universities

African Americans -- 1.22%
 Asian Americans -- 0.85%
 Hispanics -- 0.67%
 Native Americans -- 0.05%
 Caucasian Females -- 1.

5. Goods and Commodities (equipment and consumable items purchased in bulk, or a deliverable product including, but not limited to automobiles and equipment; chemicals and laboratory supplies, construction

materials and supplies; equipment parts and supplies; fuels and lubricants; janitorial and cleaning supplies; office equipment; office supplies; radio equipment; special department supplies; technical supplies; tires and tubes; traffic signals; and uniforms).

State Agencies/Authorities/Commissions/Colleges and Universities

African Americans -- 2.71%

Asian Americans -- 1.74%

Hispanics -- 1.32%

Native Americans -- 0.10%

Caucasian Females -- 4.45%

Appendix D

Consistent with the findings of the State of New Jersey Construction Services Disparity Study (October 2005) and the State of New Jersey Disparity Study of Procurement in Professional Services, Other Services, and Goods and Commodities (June 13, 2005), each Reporting Agency should aspire to allocate a portion of its total contracting dollars in accordance with the following goals.

1. Construction Services Contracts/Subcontracts (including new construction and renovations, except routine building maintenance; residential and non-residential building construction; heavy construction, such as streets, roads and bridges; and special trade construction, such as fencing, HVAC, paving and electrical.

(c) State Agencies/Authorities/Commissions

African Americans -- 6.3%
Asian Americans -- 4.34%

(d) State Colleges and Universities

African Americans -- 6.3%
Asian Americans -- 4.34%
Caucasian Females -- 12.67%

2. Construction-Related Services Contracts/Subcontracts (including design services, such as architectural, engineering and construction management services, that are performed as part of a construction project).

State Colleges and Universities

African Americans -- 4.51%
Asian Americans -- 7.11%
Hispanics -- 4.

3. Professional Services (with the exception of those professional services deemed to be construction-related, all services that are of a professional nature and requiring special licensing, education degrees and/or very highly specialized expertise, including accounting and financial services, advertising services, laboratory testing services; legal services; management consulting services; technical services and training).

State Agencies/Authorities/Commissions/Colleges and Universities

African Americans -- 2.47%
Asian Americans -- 1.47%
Hispanics -- 1.1%
Native Americans -- 0.07%
Caucasian Females -- 3.

4. Other Services (any service that is labor-intensive and neither professional nor construction-related, including, but not limited to equipment rental; janitorial and maintenance services; landfill services; laundry and dry cleaning; maintenance and repairs; printing; real property services; security services; special department supplies; subsidy, care and support; telecommunications; and temporary help).

State Agencies/Authorities/Commissions/Colleges and Universities

African Americans -- 1.22%
Asian Americans -- 0.85%
Hispanics -- 0.67%
Native Americans -- 0.05%
Caucasian Females -- 1.

4. Goods and Commodities (equipment and consumable items purchased in bulk, or a deliverable product including, but not limited to automobiles and equipment; chemicals and laboratory supplies, construction materials and supplies; equipment parts and supplies; fuels and lubricants; janitorial and cleaning supplies; office equipment; office supplies; radio equipment; special department supplies; technical supplies; tires and tubes; traffic signals; and uniforms).

State Agencies/Authorities/Commissions/Colleges and Universities

African Americans -- 2.71%
Asian Americans -- 1.74%
Hispanics -- 1.32%
Native Americans -- 0.10%
Caucasian Females -- 4.45%

GIVEN, under my hand and seal thi^s 28th day of August
Two Thousand and Nine, and of the Independence of
the United States, the Two Hundred and Thirty-Fourth.

/s/ Jon S. Corzine

Governor

[seal]

Attest:

/s/ Kay Walcott-Henderson

First Assistant Chief Counsel

STATE OF NEW JERSEY

Division of Purchase & Property
Contract Compliance Audit Unit
EEO Monitoring Program

Q15

EMPLOYEE INFORMATION REPORT

IMPORTANT-READ INSTRUCTIONS CAREFULLY BEFORE COMPLETING FORM. FAILURE TO PROPERLY COMPLETE THE ENTIRE FORM AND TO SUBMIT THE REQUIRED \$150.00 FEE MAY DELAY ISSUANCE OF YOUR CERTIFICATE. DO NOT SUBMIT EEO-1 REPORT FOR SECTION B, ITEM 11. For Instructions on completing the form, go to: http://www.state.nj.us/treasury/contract_compliance/pdf/aa302ins.pdf

SECTION A - COMPANY IDENTIFICATION

1. FID. NO. OR SOCIAL SECURITY	2. TYPE OF BUSINESS <input type="checkbox"/> 1. MFG <input type="checkbox"/> 2. SERVICE <input type="checkbox"/> 3. WHOLESALE <input type="checkbox"/> 4. RETAIL <input type="checkbox"/> 5. OTHER	3. TOTAL NO. EMPLOYEES IN THE ENTIRE COMPANY			
4. COMPANY NAME					
5. STREET	CITY	COUNTY	STATE	ZIP CODE	
6. NAME OF PARENT OR AFFILIATED COMPANY (IF NONE, SO INDICATE)		CITY	STATE	ZIP CODE	
7. CHECK ONE: IS THE COMPANY: <input type="checkbox"/> SINGLE-ESTABLISHMENT EMPLOYER <input type="checkbox"/> MULTI-ESTABLISHMENT EMPLOYER					
8. IF MULTI-ESTABLISHMENT EMPLOYER, STATE THE NUMBER OF ESTABLISHMENTS IN NJ					
9. TOTAL NUMBER OF EMPLOYEES AT ESTABLISHMENT WHICH HAS BEEN AWARDED THE CONTRACT					
10. PUBLIC AGENCY AWARDED CONTRACT					
		CITY	COUNTY	STATE	ZIP CODE

Official Use Only	DATE RECEIVED	INAUG.DATE	ASSIGNED CERTIFICATION NUMBER

SECTION B - EMPLOYMENT DATA

Report all permanent, temporary and part-time employees ON YOUR OWN PAYROLL. Enter the appropriate figures on all lines and in all columns. Where there are no employees in a particular category, enter a zero. Include ALL employees, not just those in minority/non-minority categories, in columns 1, 2, & 3. **DO NOT SUBMIT ANEEO-1 REPORT.**

JOB CATEGORIES	ALL EMPLOYEES			PERMANENT MINORITY/NON-MINORITY EMPLOYEE BREAKDOWN										
	COL. 1 TOTAL (Cols.2 &3)	COL. 2 MALE	COL. 3 FEMALE	***** MALE*****					***** FEMAL *****					
				BLACK	HISPANIC	AMER. INDIAN	ASIAN	NON MIN.	BLACK	HISPANIC	AMER. INDIAN	ASIAN	NON MIN.	
Officials/ Managers														
Professionals														
Technicians														
Sales Workers														
Office & Clerical														
Craftworkers (Skilled)														
Operatives (Semi-skilled)														
Laborers (Unskilled)														
Service Workers														
TOTAL														
Total employment From previous Report (if any)														
Temporary & Part-Time Employees	The data below shall NOT be included in the figures for the appropriate categories above.													

12. HOW WAS INFORMATION AS TO RACE OR ETHNIC GROUP IN SECTION B OBTAINED? <input type="checkbox"/> 1. Visual Survey <input type="checkbox"/> 2. Employment Record <input type="checkbox"/> 3. Other (Specify)	14. IS THIS THE FIRST Employee Information Report Submitted? 1. YES <input type="checkbox"/> 2. NO <input type="checkbox"/>	15. IF NO, DATE LAST REPORT SUBMITTED MO. DAY YEAR / / /
13. DATES OF PAYROLL PERIOD USED From: _____ To: _____		

SECTION C - SIGNATURE AND IDENTIFICATION

16. NAME OF PERSON COMPLETING FORM (Print or Type)	SIGNATURE	TITLE	DATE MO DAY YEAR / / /		
17. ADDRESS NO. & STREET	CITY	COUNTY	STATE	ZIP CODE	PHONE (AREA CODE, NO., EXTENSION)



**STATE OF NEW JERSEY
DEPARTMENT OF THE TREASURY
DIVISION OF PURCHASE AND PROPERTY**

Q16

**33 WEST STATE STREET, P.O. BOX 230
TRENTON, NEW JERSEY 08625-0230**

OWNERSHIP DISCLOSURE FORM

BID SOLICITATION #: _____ **VENDOR {BIDDER}:** _____

**ALL PARTIES ENTERING INTO A CONTRACT WITH THE STATE ARE REQUIRED TO PROVIDE THE
INFORMATION REQUESTED PURSUANT TO N.J.S.A. 52:25-24.2.**

PLEASE NOTE THAT IF THE VENDOR/BIDDER IS A NON-PROFIT ENTITY, THIS FORM IS NOT REQUIRED.

PART 1

YES NO

Are there any individuals, partners, members, stockholders, corporations, partnerships, or limited liability companies owning a 10% or greater interest in the Vendor {Bidder}?

If you answered, "YES" above, you must disclose the following: (a) the names and addresses of all stockholders in the corporation who own 10 percent or more of its stock, of any class; (b) all individual partners in the partnership who own a 10 percent or greater interest therein; or, (c) all members in the limited liability company who own a 10 percent or greater interest therein.

NAME	_____
ADDRESS 1	_____
ADDRESS 2	_____
CITY	_____ STATE _____ ZIP _____

NAME	_____
ADDRESS 1	_____
ADDRESS 2	_____
CITY	_____ STATE _____ ZIP _____

NAME	_____
ADDRESS 1	_____
ADDRESS 2	_____
CITY	_____ STATE _____ ZIP _____

NAME	_____
ADDRESS 1	_____
ADDRESS 2	_____
CITY	_____ STATE _____ ZIP _____

NAME	_____
ADDRESS 1	_____
ADDRESS 2	_____
CITY	_____ STATE _____ ZIP _____

Attach Additional Sheets If Necessary.

PART 2

YES NO

Of those entities disclosed above owning a 10% or greater interest in the Vendor {Bidder}, are there any individuals, partners, members, stockholders, corporations, partnerships, or limited liability companies owning a 10% or greater interest of those listed entities?

If you answered, "YES" above, you must disclose the following: (a) the names and addresses of all stockholders in the corporation who own 10 percent or more of its stock, of any class; (b) all individual partners in the partnership who own a 10 percent or greater interest therein; or, (c) all members in the limited liability company who own a 10 percent or greater interest therein. Please note that this disclosure shall be continued until names and addresses of every non-corporate stockholder, and individual partner, and member, exceeding the 10 percent ownership criteria established in this act, has been identified.

Name of the entity listed above to which the disclosure below applies: _____

NAME	_____
ADDRESS 1	_____
ADDRESS 2	_____
CITY	_____ STATE _____ ZIP _____

NAME	_____
ADDRESS 1	_____
ADDRESS 2	_____
CITY	_____ STATE _____ ZIP _____

NAME	_____
ADDRESS 1	_____
ADDRESS 2	_____
CITY	_____ STATE _____ ZIP _____

NAME	_____
ADDRESS 1	_____
ADDRESS 2	_____
CITY	_____ STATE _____ ZIP _____

NAME	_____
ADDRESS 1	_____
ADDRESS 2	_____
CITY	_____ STATE _____ ZIP _____

Attach Additional Sheets If Necessary.

PART 3

As an alternative to completing this form, a Vendor {Bidder} with any direct or indirect parent entity which is publicly traded may submit the name and address of each publicly traded entity and the name and address of each person that holds a 10 percent or greater beneficial interest in the publicly traded entity as of the last annual filing with the federal Securities and Exchange Commission or the foreign equivalent, and, if there is any person that holds a 10 percent or greater beneficial interest, also shall submit links to the websites containing the last annual filings with the federal Securities and Exchange Commission or the foreign equivalent and the relevant page numbers of the filings that contain the information on each person that holds a 10 percent or greater beneficial interest.

PREVAILING WAGE ACT COMPLIANCE DECLARATION

The Contractor hereby agrees to comply in all respects with the New Jersey Prevailing Wage Act, Chapter 150, P.L. 1963 as amended. A copy of the prevailing wage rates pertaining to the work issued by the New Jersey Department of Labor and Industry entitled, "Prevailing Wage Rate Determination", is attached at the close of this section, or is available upon request at the Offices of the South Jersey Port Corporation. Pursuant to N.J.S.A., 34:11-56.37 and 34:11-56.38, Prevailing Wage Act, no public works contract may awarded to any contractor or subcontractor or to any firm, corporation or partnership in which they have an interest on the disbarred bidders list located at the end of this specification, or available upon request at the Offices of the South Jersey Port Corporation, until expiration date give. Workmen shall be paid not less than such prevailing wage rate. In the event it is found that any workmen employed by the Contractor or any Subcontractor covered by the contract herein has been paid a rate of wages less than the prevailing rate required to be paid such contract, the Owner may terminate the Contractor's or Subcontractor's right to proceed with the work or such part of the work as to which there has been a failure to pay required wages and to prosecute the work to completion or otherwise. The Contractor and his sureties shall be liable to the Owner for any excess cost occasioned thereby.

Before final payment is made by or on behalf of the Owner any sum or sums due to the work, the Contractor or Subcontractor shall file with the treasurer of the Owner, written statements in a form satisfactory to the Commissioner of Labor and Industry certifying to the amounts then due owing from such contractor or subcontractor filling such statement to any and all workmen wages due on account of the work, setting forth therein the name of the persons whose wages are unpaid and the amount due to each respectively which statement shall be certified by the oath of the Contractor or Subcontractor as the case may be in accordance with the said New Jersey Prevailing Wage Act.

The prevailing wage rate shall be determined by the Commissioner of Labor and Industry or his duly authorized deputy or representative.

The undersigned in an (individual)(partnership)(corporation) under the Laws of the State of _____ having principal offices at _____.

Signature: _____

Print Name: _____

Company Name : _____

Address : _____

Phone Number: _____

COMPLIANCE WITH PUBLIC WORKS CONTRACTOR REGISTRATION ACT

The bidder shall comply with the Public Works Contractor Registration Act P.L. 1999, c 238 (N.J.S.A, 34:11-56.48, et seq.) on all bids for public works as defined in the law. Proof of compliance with this law when it applies, must be submitted with the bid.

- Attached hereto is a copy of Certificate of Registration pursuant to N.J.S.A. 34:11-56.54

Or

- Attached hereto is a copy of filed registration from and proof of payment of the registration fee pursuant to N.J.S.A. 34:11-56.55

Bidders Signature: _____

Bidders Name: _____

Address of Bidder: _____

Signature of Affiant: _____

Printed Name & Title of Affiant: _____

NOTARIZATION SECTION

Subscribed and sworn before me this _____ day of _____, 20____.

Notary Public of _____

My Commission Expires: _____

BUY AMERICAN NOTICE

In the performance of the work under this contract the contractor and all subcontractors shall use only domestic materials. Builders may bid using non-domestic material but shall specify wherever such non-domestic materials are bid the difference in cost between the domestic and non-domestic materials and shall explain any justification for the use of non-domestic materials such as but not limited to unavailability, inferiority, incompatibility, impracticality, increased cost of domestic materials, etc.

Buy America **Notice**

All Federally Funded Construction Projects

Reference:

The FHWA Buy America statutory provisions are in 23U.S.C.313 and the regulatory provisions are in 23CFR635.410.

Buy America

Q&A's: http://www.fhwa.dot.gov/construction/contracts/buyam_ga.cfm

Applicability:

Applicable to all Federal-aid projects.

Guidance:

Simply stated, the FHWA's Buy America policies require a DOMESTIC manufacturing process for ALL steel or iron products that are permanently incorporated in a Federal-aid highway construction project. Manufacturing begins with the initial melting and mixing, and continues through the coating stage. Any process which modifies the chemical makeup, physical shape or finish is considered a manufacturing process and as such must be performed in the United States. Waivers may be granted, in rare cases that meet specified criteria. Refer to the Q&A's above for more details.

Buy America requirements apply to the entire federal aid project even if some steel or iron products are purchased with non federal funds. All steel/iron must be manufactured in the United States.

Buy America provisions do allow use of a small portion of foreign steel and iron materials (less than one tenth of one percent of the total contract cost [0.1%] or \$2500, whichever is greater). Be vigilant and document. The consequences of exceeding this amount can be severe. Maintain a separate file for "Buy America" to facilitate oversight, certifications and compliance. It's that important.

Buy America requirements apply to all UTILITY RELOCATION WORK (regardless of funding) that is part of a FHWA funded contract and to all federally funded standalone utility work. Standalone, non-FHWA funded, contracts are NOT covered.

Compliance:

The RE needs to receive the Buy America certification at time of delivery--absolutely PRIOR TO incorporating the steel/iron product in the project. Typically, the certification states:

"All manufacturing processes for these steel and iron materials, including the application of coatings, have occurred in the United States."

The certification MUST BE current, dated, signed and be specific to the material and project at hand. Step certification is encouraged when manufacturing occurs at different locations. This involves separate, self-supporting, certifications that are prepared at each location and accompany the product to the job site—a documentation trail confirming ALL manufacturing in the US.

Contract Changes and Time ^{Q19}

Inherent in every project – processing is key

Reference:

Title 23 C.F.R. 635.120 - Changes and extra work
Title 23 C.F.R. 635.121 - Contract time and contract time extensions
2007 NJDOT Standard Specifications for Road and Bridge Construction

Guidance:

Contract changes and progress of work must be monitored and documented daily.

The State's standard specifications shall govern the approval of changes in a contract. Below are some provisions that apply:

- Do not deviate from the requirements of the contract unless and until a field order is issued.
- Reimbursement cannot be made until a change order is approved by the Department.
- Extensions in contract time will only be granted for excusable, compensable delays and only for work defined on the critical path of the project, as defined in an approved project schedule.

Issue a formal "Notice to Proceed" (NTP) and stipulate a Contract Completion Date.

Example NTP: *The NTP date for this project is Friday, June 15, 2012. The duration for this project per section 100.03 of the Supplemental Specifications is sixty (60) calendar days. The date for final completion is Tuesday, August 14, 2012.*

Basic Requirements:

"Time is of the essence as to all time frames stated in the Contract", Section 108.10 NJDOT Standard Specification

Any new or extra work needs to be defined and approved prior to being included in the contract. This approval is done through a change order which requires written justification, a breakdown of costs and quantities, and timely approvals.

Contract line item overruns are not permissible without formal requests and approvals.

Time shall always be evaluated as part of a change order.

Change orders for a time extension only must be fully substantiated in accordance with the contract requirements and specifications. Weather, right-of-way, utilities, and/or rail road work are not normally a legitimate basis for excusable, compensable delays.

Liquidated Damages: If changes in time are not fully justified and documented, liquidated damages may be assessed per the contract documents. Daily documentation of work activities is crucial.

The standard form DC-173A will be used to document the change order.

New or Supplemental Costs:

All new or supplemental costs **must be** negotiated, itemized and justified. All documentation of the negotiations, including the basis of cost, must be on file and included in the change order request.

DBE/ESBE/SBE Program

Project Responsibility from Day One

References:

- FHWA regulatory provisions: 49 CFR 26
- NJDOT's Construction Procedure Handbook for ESBE/DBE & SBE Program Implementation: Section V, Subsection B
- NJDOT DBE & ESBE Programs: <http://www.state.nj.us/transportation/business/civilrights/dbe.shtm>

Applicability:

All federal aid projects with a contract DBE/ESBE requirement.

Guidance:

The DBE Program is a legislatively mandated USDOT program. The mission of NJDOT's Disadvantaged and Small Business Programs is to promote contracting opportunities for small, socially and economically disadvantaged firms who seek to do business with the NJDOT.

DBE contract specifications are legally binding and **must be enforced in the same fashion as any other contract requirement**. Failure to carry out contract provisions may result in loss of Federal funds. The success of these programs is achieved by thoroughly implementing the monitoring and reporting procedures in place AS THE PROJECT PROGRESSES. REs will then be able address any issues early and take effective steps to ensure proper administration of the DBE/ ESBE/SBE Program and avoid any penalties.

Implementation:

Beginning at the commencement of the project, the RE must continuously monitor DBE/ESBE/SBE participation as the project progresses to ensure that that the assigned DBE /ESBE/SBE goal on the contract will be met by the time the project is completed. This is a project responsibility. Maintain a separate file.

1. Check Recommendation To Award memorandum and the Schedule of Participation ESBE/DBE/SBE Form CR-266 (former "Form A") to determine status of subcontractors to monitor for compliance.
2. During the course of the Contract, the RE will monitor true participation by comparing contractor DBE/ ESBE/SBE Goal commitments against each Request for Approval to Sublet Form DC-18. In addition, the RE will cross check the Daily Work Reports with each affected Form DC-18, the Recommendation To Award, and the Utilization of ESBE/DBE/SBE Monthly Report Form CR-267.
3. During construction the RE and staff will use the Daily Work Report to document on-site monitoring of stipulated DBE work items and contractor performing the work in order to insure compliance.
4. The RE will notify the Person in Responsible Charge and the Contractor in writing of any violations and will direct the Contractor to comply with these requirements. Revisions can only be made to the committed DBE/ ESBE/SBE Program when the Contractor submits a revised Form CR-266.
5. Failure of the Contractor to comply will result in the RE notifying the Person in Responsible charge, NJDOT District Office, and DCR/AA by memorandum and presenting pertinent documents for their review and action. The RE must follow-up with all promptly to insure timely resolution.
6. If the DBE/ ESBE/SBE commitment is not fulfilled, documentation supporting adequate good faith effort (GFE) must be promptly submitted by the Contractor with Form CR-268. GFE will be reviewed by DCR/AA based on the guidance set forth in 49 CFR Part 26 Appendix A. .

Pedestrian Facilities and ADA compliance – Curb Ramps

Must Conform To Standards and Contract Plans

References:

All pedestrian facilities constructed or reconstructed must provide safe and easy accessibility **for all users**.

The Americans with Disabilities Act (ADA) of 1990

Section 504 of the Rehabilitation Act of 1973

28 CFR Part 35.151(e)

NJDOT Construction Details 607 and 608

Guidance:

Inspectors need to have immediate on-site access to contract plans.

It is the inspector's responsibility to insure that all sidewalks and ramps are constructed in strict accordance with contract plans. Slope is of critical importance; as are location, alignment, length, width and depth. Check plans. Measure-measure-measure, compare with plans and **DOCUMENT** conformance and quantities.

Immediately elevate questions or 'issues' for discussion and resolution. Document!

It starts with the concrete forms - PRIOR TO the placement of concrete.

NJDOT Standard Specifications, Sections 606 and 607, require RE approval of excavation and forms prior to placing concrete. Nonconformance at this stage means nonconformance with final product.

All measurements, checks, approvals and findings, including pay quantities, must be clearly documented. They become "Source Documents" – a critical item necessary to support payment.

This simple and basic guidance will promote compliance and avoid completed work that does not conform to contract plans and specifications.

Be Vigilant:

The plans should be consistent with established design standards. If you note any design problems or inconsistencies, document and bring them to the attention of the RE/person in charge. Field inspection and documentation must occur for the following:

- The curb ramp type and crossing location are consistent with the plans.
- The curb ramp running slope **does not exceed 8.3%**.
- The curb ramp cross slope and connecting sidewalks **do not exceed 2.0%**.
- The turning areas (landings) are a minimum of 4 foot by 4 foot and cross slopes do not exceed 2% in both directions.
- All street connections, joints, and grade changes must be flush...no lip.
- There are no protrusions or obstacles within the pedestrian accessible route.
- The surface is firm, stable, & nonslip, including during temporary conditions.
- The pedestrian accessible route is free of utilities unless the design allows for exceptions.
- Detectable warning surface with truncated domes have been properly installed, are color contrasting, and aligned in the direction of pedestrian travel.
- No water ponding at the curb ramp or in the pedestrian pathway.
- Accessibility (walkway) has been provided to pedestrian push buttons, including a turning space at the button location.
- Diagonal ramps are discouraged. If provided for in the plans, they must provide a turning space at the back of curb to facilitate travel to the adjacent pedestrian pathway.

Responsible Charge

Every federal-aid project must have a person in responsible charge.

Reference:

23 CFR 635.105 – ‘*Supervising Agency*’: the State Transportation Department (STD) has responsibility for the construction of all Federal-aid projects, whether or not; it or a local public agency (LPA) performs the work. This section stresses that such projects must receive adequate supervision and inspection to insure that they are completed in conformance with approved plans and specifications.

The regulation provides that the STD and LPA must provide a full time employee to be in "responsible charge" of the project. This cannot be the consultant.

Purpose:

To insure that (think *public interest*) every project receives adequate supervision and inspection to insure that it is completed in conformance with contract plans and specs.

Implementation:

Implementation and accountability is mandated through the person in responsible charge. Who is this person?

STD-For projects administered by the STD, the regulation requires that the person in "responsible charge" be a full-time employed state engineer. This requirement applies even when consultants are providing construction engineering services.

LPA-For locally administered projects, the regulation requires that the person in "responsible charge" be a full time employee of the LPA. The regulation is silent about engineering credentials. Thus, the person in "responsible charge" of LPA administered projects need not be an engineer. This requirement applies even when consultants are providing construction engineering services.

Duties:

Regardless of whether the project is administered by the STD or a LPA, the person designated as being in "responsible charge" is expected to be a full time public employee (not a consultant) who is accountable for the project. This person, may share duties, but is expected to be able to perform the following duties and functions:

- Administers inherently governmental project activities, including those dealing with cost, time, adherence to contract requirements, construction quality and scope of Federal-aid projects;
- Maintains familiarity of day to day project operations, including project safety issues;
- Makes or participates in decisions about changed conditions or scope changes that require change orders or supplemental agreements
- Reviews financial processes, transactions and documentation to ensure that safeguards are in place to minimize fraud, waste, and abuse; and
- Directs project staff, agency or consultant, to carry out project administration and contract oversight, including proper documentation.
- Is aware of the qualifications, assignments and on-the-job performance of the agency and consultant staff at all stages of the project.
- Visits and reviews the project on a frequency that is commensurate with the magnitude and complexity of the project
- On the jobsite for the time needed to verify and insure that the project receives adequate supervision and inspection to insure that work is accomplished in conformance with approved plans and specifications.

Source Documents

An Absolute Must Have

Reference:

23 CFR 635.123: Determination and documentation of PAY QUANTITIES.

Applicability:

Applicable to all Federal-aid projects—basis for payment.

Guidance:

What is a “Source Document”? Look at it in reverse: it’s a document prepared at the source--the ‘source’ being the point of delivery or the location of construction activity.

This is essentially the handwritten “receipt” of exactly how many and what was delivered. It is the **single most important document that substantiates quality and quantities and provides the required basis for payment to the contractor.**

The document consists of notes (documentation) of: counts; measurements (length, width, depth, and slope); calculations of area, volume, weights, etc; sketches; a STATEMENT of compliance with contract plans and specs; field changes; comments; and delivery tickets collected/initialed by the inspector at the point of unloading.

Who develops this documentation? The inspector, who is assigned to that project/location to protect the public interest and to insure that the number, size, and characteristics of what is being delivered match the plans/specs, completes this basic and essential documentation. Incorporate ‘established’ quantities into a Quantity Summary Sheet for each work item.

Importance:

Highest level! This source documentation establishes quantities for payment. Without it, the eligibility of pay quantities may come under question. Later, after the fact, verification is very time consuming and often not possible.

Examples:

Item # ____; Sidewalk-Forms: *Checked and measured forms for the sidewalk and ADA ramp at the NE corner of Grand and Market. Specific measurements including depth and slope are shown below (or are shown on the sketches below) along with quantity calculations. Also, noted on plan sheet # 21. Forms were clean, stable and uniform. Base was solid. Expansion joints were in place. All measurements, including depth and slopes, are in conformance with contract plans-a section was added to reach push button. The contractor was given approval to place concrete. (Sect. 606.03.02 DOT Spec)*

*Observed the **placement of concrete** at the NE corner of Grand and Market. Prior approval of forms had been granted. Placement and finishing procedures in accordance with specs. No access water. Curing compound placed 15 minutes after finishing. **Total quantity 24 SY** based on measurements taken. See plan sheet 21 of the contract plans. See calculations.*

Item # ____: **HMA Surface Coarse:** *Inspected HMA placement from Station 3+50 to 9+50. Took numerous measurements of D, W, and Temp as follows. Compaction/finish observed. Equipment and pattern as per spec (describe). Tickets collected at point of unloading. Initialed each w/station. Total tonnage _____. # of tickets _____. Refused one truck (# 254) due to time in transit was substantially over that allowed by spec.*

Item # ____: **Tack Coat;** *Observed test strip and noted several nozzles not functioning. Required repair of distributor to achieve uniform application. Repaired. Checked quantities before and after to affirm actual usage and pay quantity. See notes below.*

IMPORTANT NOTICE

NEW "PAY-TO-PLAY" RESTRICTIONS TO TAKE EFFECT NOVEMBER 15, 2008

Individual Certification of Compliance with Executive Order No. 117 (2008)

I hereby certify as follows:

On or after November 15, 2008, I have not solicited or made any reportable contribution of money or pledge of contribution, including in-kind contributions or company or organization contributions, to the following:

- a) Any candidate committee and/or election fund of the Governor;
- b) A State political party committee;
- c) A legislative leadership committee;
- d) A county political party committee; or
- e) A municipal political party committee

I certify that, to the best of my knowledge and belief, the foregoing statements by me are true. I am aware that if any of the statements are willfully false, I am subject to punishment.

Signed: _____

Print Name: _____ Date: _____

State of New Jersey
Executive Order #117

Governor Jon S. Corzine

WHEREAS, the residents of New Jersey are entitled to a government that is effective, efficient, and free from corruption, favoritism, and waste; and

WHEREAS, in pursuit of those goals, a series of actions have been taken in New Jersey since 2004 – through legislation, executive order, and regulation – to protect the integrity of government contractual decisions and increase the public’s confidence in government by prohibiting the awarding of government contracts to business entities that also are contributors to certain candidates and political parties; and

WHEREAS, among those actions were the issuance of Executive Order No. 134 (2004) and the codification of its provisions into statute in P.L.2005, c.51 (C.19:44A-20.13 et seq.) (“Chapter 51”); and

WHEREAS, since its adoption, Chapter 51 has significantly reduced the influence of contractor contributions in the process of awarding State government contracts and has proven to be an effective method of ensuring that merit and cost-effectiveness drive the government contracting process; and

WHEREAS, this administration is committed to ensuring the highest ethical standards in government contracting and rooting out corruption, favoritism, and waste; and

WHEREAS, experience has shown that additional measures are needed to ensure there is no dilution of the protections provided by Chapter 51 against the improper influence of political contributions on the process of awarding State government contracts and to ensure compliance with the provisions of Chapter 51; and

WHEREAS, many State government contractors, particularly those that provide professional services, are business entities whose form of business organization and ownership structure are such that the political contribution limits in Chapter 51 apply to few if any of the individuals who own or control the entity; and

WHEREAS, the strong public interest in limiting political contributions by businesses that contract with the State requires that the contribution limits in Chapter 51 be applied to such individuals and that those limits otherwise be applied in such a way that the purposes of Chapter 51 will be served regardless of the form of business organization of the State government contractor; and

WHEREAS, because New Jersey’s campaign finance laws permit large, and in some cases unlimited, political contributions to flow between and among various types of political committees and State officeholders, the effectiveness of the restrictions in Chapter 51 can be, and

have been, undermined by the current ability of State government contractors to make large contributions to legislative leadership committees and municipal political party committees; and

WHEREAS, the Constitution of this State requires the Governor to manage the operations of State government effectively and fairly, uphold the law to ensure public order and prosperity, and confront and uproot malfeasance in whatever form it may take; and

WHEREAS, it is the Governor's responsibility to safeguard the integrity of the State government procurement process by ensuring that there is no dilution of the protections provided by Chapter 51 against the improper influence of political contributions on the process of awarding and overseeing the performance of State government contracts and that there be full compliance with the provisions of Chapter 51;

NOW, THEREFORE, I, JON S. CORZINE, Governor of the State of New Jersey, by virtue of the authority vested in me by the Constitution and by the Statutes of this State, do hereby ORDER and DIRECT:

1. For the purposes of this Order:

a. "Business entity" means:

i. a for-profit entity as follows:

- A. in the case of a corporation: the corporation, any officer of the corporation, and any person or business entity that owns or controls 10% or more of the stock of the corporation;
- B. in the case of a general partnership: the partnership and any partner;
- C. in the case of a limited partnership: the limited partnership and any partner;
- D. in the case of a professional corporation: the professional corporation and any shareholder or officer;
- E. in the case of a limited liability company: the limited liability company and any member;
- F. in the case of a limited liability partnership: the limited liability partnership and any partner;
- G. in the case of a sole proprietorship: the proprietor; and
- H. in the case of any other form of entity organized under the laws of this State or any other state or foreign jurisdiction: the entity and any principal, officer, or partner thereof;

ii. any subsidiary directly or indirectly controlled by the business entity;

- iii. any political organization organized under section 527 of the Internal Revenue Code that is directly or indirectly controlled by the business entity, other than a candidate committee, election fund, or political party committee; and
 - iv. with respect to an individual who is included within the definition of business entity, that individual's spouse or civil union partner, and any child residing with the individual, provided, however, that, this Order shall not apply to a contribution made by such spouse, civil union partner, or child to a candidate for whom the contributor is entitled to vote or to a political party committee within whose jurisdiction the contributor resides unless such contribution is in violation of section 9 of P.L.2005, c.51 (C.19:44A-20.13 et seq.) ("Chapter 51").
- b. "Contribution" means a contribution reportable by the recipient under "The New Jersey Campaign Contributions and Expenditures Reporting Act," P.L.1973, c.83 (C.19:44A-1 et seq.) made on or after the effective date of this Order.
2. Any Executive Branch department, agency, authority, or independent State authority charged with implementing and enforcing Chapter 51 shall apply its provisions to a "business entity" as defined in Paragraph 1(a) of this Order in the same manner as those provisions apply to a "business entity" as defined in section 5 of Chapter 51.
 3. Any Executive Branch department, agency, authority, or independent State authority charged with implementing and enforcing Chapter 51 shall apply its provisions to a contribution made to a legislative leadership committee or a municipal political party committee in the same manner as those provisions apply to a contribution to any candidate committee, election fund, or political party committee identified in Chapter 51.
 4. Any Executive Branch department, agency, authority, or independent State authority charged with implementing and enforcing Chapter 51 shall apply its provisions to a contribution made to a candidate committee or election fund of any candidate for or holder of the office of Lieutenant Governor in the same manner as those provisions apply pursuant to Chapter 51 to a contribution to any candidate committee or election fund of any candidate for or holder of the office of Governor.
 5. This Order shall take effect on November 15, 2008 and is intended to have prospective effect only. This Order shall not apply to any contribution made prior to November 15, 2008.

GIVEN, under my hand and seal this 24th day of September, Two Thousand and Eight, and of the Independence of the United States, the Two Hundred and Thirty-Third.

/s/ Jon S. Corzine

Governor

[seal]

Attest:

/s/ Edward J. McBride, Jr.

Chief Counsel to the Governor

SOUTH JERSEY PORT CORPORATION - DISCLOSURE OF INVESTMENT ACTIVITIES IN IRAN FORM

BID SOLICITATION # AND TITLE: _____

VENDOR NAME: _____

Pursuant to N.J.S.A. 52:32-57, et seq. (P.L. 2012, c.25 and P.L. 2021, c.4) any person or entity that submits a bid or proposal or otherwise proposes to enter into or renew a contract must certify that neither the person nor entity, nor any of its parents, subsidiaries, or affiliates, is identified on the New Jersey Department of the Treasury’s Chapter 25 List as a person or entity engaged in investment activities in Iran. The Chapter 25 list is found on the Division’s website at <https://www.state.nj.us/treasury/purchase/pdf/Chapter25List.pdf>. Vendors/Bidders must review this list prior to completing the below certification. If the SJPC finds a person or entity to be in violation of the law, s/he shall take action as may be appropriate and provided by law, rule or contract, including but not limited to, imposing sanctions, seeking compliance, recovering damages, declaring the party in default and seeking debarment or suspension of the party.

CHECK THE APPROPRIATE BOX

I certify, pursuant to N.J.S.A. 52:32-57, et seq. (P.L. 2012, c.25 and P.L. 2021, c.4), that neither the Vendor/Bidder listed above nor any of its parents, subsidiaries, or affiliates is listed on the New Jersey Department of the Treasury’s Chapter 25 List of entities determined to be engaged in prohibited activities in Iran.

OR

I am unable to certify as above because the Vendor/Bidder and/or one or more of its parents, subsidiaries, or affiliates is listed on the New Jersey Department of the Treasury’s Chapter 25 List. I will provide a detailed, accurate and precise description of the activities of the Vendor/Bidder, or one of its parents, subsidiaries or affiliates, has engaged in regarding investment activities in Iran by completing the information requested below.

Entity Engage in Investment Activities _____

Relationship to Vendor/Bidder _____

Description of Activities _____

Duration of Engagement _____

Anticipate Cessation Date _____

Attach additional sheets if necessary _____

CERTIFICATION

I, the undersigned, certify that I am authorized to execute this certification on behalf of the Vendor, that the foregoing information and any attachments hereto, to the best of my knowledge are true and complete. I acknowledge that the South Jersey Port Corporation is relying on the information contained herein, and that the Vendor is under a continuing obligation from the date of this certification through the completion of any contract(s) with the SJPC to notify the SJPC in writing of any changes to the information contained herein; that I am aware that it is a criminal offense to make a false statement or misrepresentation in this certification. If I do so, I may be subject to criminal prosecution under the law, and it will constitute a material breach of my contract(s) with the SJPC, permitting the SJPC to declare any contract(s) resulting from this certification void and unenforceable.

Signature: _____

Date: _____

Print Name: _____

Print Title: _____

Rev. 12.13.2021

PLEASE BE ADVISED

New Jersey Election Law Enforcement Commission Requirements for ALL Bids and Requests for Proposals

All Business entities are advised of their responsibility to file an annual disclosure statement of political contributions with the New Jersey Election Law Enforcement Commission (ELEC) pursuant to N.J.S.A. 19:44A20.27 if they receive contracts in excess of \$50,000.00 from public entities in a calendar year. Business entities are responsible for determining if filing is necessary. Additional information on this requirement is available from ELEC at 888-313-3532 or at www.elec.state.nj.us.

DISCLOSURE OF CONTRIBUTIONS TO NEW JERSEY ELECTION LAW ENFORCEMENT COMMISSION IN ACCORDANCE WITH N.J.S.A. 19:44A-20.27

STATE OF _____

: SS

COUNTY OF _____

I, _____ of the _____ of _____ in the County of _____ and the State of _____ of full age, being duly sworn according to law on my oath depose and say that:

I am _____, a _____
(Name) (Title, Position, etc.)
in the firm of _____ the bidder making the proposal
to _____
(Name of Owner) (Contract No. – Description)

and that I executed the said Proposal with full Authority to do so; that said Bidder acknowledges our responsibility to file an annual disclosure statement of political contributions with the New Jersey Election Law Enforcement Commission (ELEC) pursuant to N.J.S.A. 19:44A-20.27 if in receipt of contracts in excess of \$50,000.00 from public entities in a calendar year. I further acknowledge that business entities are solely responsible for determining if filing is necessary and that all statements contained in said Proposal and in this Affidavit are true and correct, and made with full knowledge that the

(Name of Owner)

relies upon the truth of the statements contained in said Proposal and in the statements contained in this Affidavit in awarding the Contract for the said project.

I further warrant that no person or selling agency has been employed or retained to solicit or secure such contract upon an agreement or understanding for commission, percentage brokerage, or contingent fee, except Bona Fide employees of the Contractor, and as may be permitted by law.

Name: _____
(print)

Subscribed and Sworn to before me this _____ day of _____ 20__.

Notary Public of _____

My Commission Expires: _____

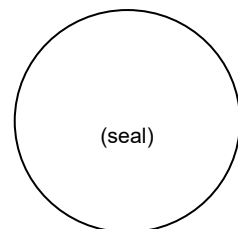

NEW JERSEY’S DIANE B. ALLEN EQUAL PAY ACT ACKNOWLEDGEMENT

Pursuant to the DIANE B. ALLEN EQUAL PAY ACT, N.J.S.A. 34:11-56.14.b., the Contractor shall provide to the Commissioner of the New Jersey Department of Labor and Workforce Development, through certified payroll records required pursuant to N.J.S.A. 34:11-56.25 et seq., information regarding the gender, race, job title, occupational category, and rate of total compensation of every employee of the employer employed in the State in connection with the contract. The Contractor shall provide the Commissioner, throughout the duration of the contract with an update to the information whenever payroll records are required to be submitted pursuant to N.J.S.A. 34:11-56.25 et seq.

Information regarding the Diane B. Allen Equal Pay Act and its requirements may be obtained from the New Jersey Department of Labor and Workforce Development (LWD) web site at: <https://nj.gov/labor/equalpay/equalpay.html>

LWD forms may be obtained from the online web site at: https://nj.gov/labor/forms_pdfs/equalpayact/MW-562withoutfein.pdf

The undersigned is an (individual) (partnership) (corporation) under the Laws of the State of _____ having principal offices at _____.

(Signed)

(Name - Type or Print)

(Company Name)

(Address)

(Telephone Number)

CHAPTER 60
PREVAILING WAGES FOR PUBLIC WORKS

SUBCHAPTER 9. ASSURANCES FOR PAYMENT OF PREVAILING WAGE

12:60-9.1 Certification by bidder with lowest bid by 10 percent or more

(a) When a public body engages in competitive bidding for public work subject to the provisions of the New Jersey Prevailing Wage Act (PWA), the person who makes the lowest bid for the contract by 10 percent or more under the amount of the next lowest bid shall prior to award of the contract certify to the public body on the form found at N.J.A.C. 12:60 Appendix that the prevailing wage rates required by the PWA shall be paid in performing the work under the contract.

(b) If the bidder does not provide the certification required pursuant to (a) above prior to the award of the contract, the public body shall award the contract to the next lowest responsible and responsive bidder.

12:60-9.2 Required contract provisions concerning payment of prevailing wage

(a) Every contract for the performance of public work shall contain the following contract provisions:

1. "Attached hereto and incorporated herein is(are) the Department of Labor and Workforce Development prevailing wage determination(s) for the locality and craft(s) that will be employed in the performance of work under this contract. It is hereby stipulated that each individual who performs work under this contract shall be paid not less than the prevailing wage rate to which that worker is entitled under the New Jersey Prevailing Wage Act, as reflected in the appropriate Department of Labor and Workforce Development prevailing wage determination"; and

2. "In the event it is found that any worker employed by the contractor or any subcontractor covered by this contract has been paid a rate of wages less than the prevailing wage rate required to be paid by this contract, the public body, the lessee to whom the public body is leasing a property or premises or the lessor from whom the public body is leasing or will be leasing a property or premises may terminate the contractor's or subcontractor's right to proceed with the work, or such part of the work as to which there has been a failure to pay required wages, and to prosecute the work to completion or otherwise. The contractor and his sureties shall be liable to the public body, any lessee to whom the public body is leasing a property or premises, or to any lessor from whom the public body is leasing or will be leasing a property or premises for any excess costs occasioned by the termination of the contractor's or subcontractor's right to proceed with the work, or such part of the work as to which there has been a failure to pay required wages."

APPENDIX
54 N.J.R. 1009(a)

In the matter of an award) STATE OF NEW JERSEY
of a)
contract for public work for) DEPARTMENT OF LABOR AND
a)
project described as:) WORKFORCE DEVELOPMENT
) DIVISION OF WAGE &
)
[Enter project description) HOUR COMPLIANCE
here])
)
)
) Certification of Lowest Bidder

LOWEST BIDDER PREVAILING WAGE CERTIFICATION

_____, of full age and under oath, duly provides the following sworn statement:

(1). I am the owner and/or highest-ranking official or officer of a company or firm named _____, which holds a currently valid public works contractor registration pursuant to the New Jersey Public Works Contractor Registration Act, N.J.S.A. 34:11-56.48 et seq., certificate number _____.

(2). I submitted a bid for a contract award in the above identified project and the public body has informed me that I am the lowest bidder by 10 percent or more as compared to the next lowest bid submitted.

(3). The amount of my bid does include paying the prevailing wage rate to all workers who perform work on the project at rates of pay, including both base wage and fringe benefits, set forth in applicable Wage Determinations, (1) for the appropriate locality, (2) for the appropriate work classification (e.g., carpenter, electrician, mason, plumber), and (3) for the appropriate job title (e.g., Apprentice, Journeyman, Forman), published by the New Jersey Department of Labor and Workforce Development (NJDOL) pursuant to the New Jersey Prevailing Wage Act (NJPWA), N.J.S.A. 34:11-56.25 et seq., and corresponding NJDOL rules, N.J.A.C. 12:60.

I certify under penalty of perjury that the foregoing statements made by me are true. I am aware that if any of the foregoing statements made by me are false, I am subject to punishment. See N.J.S.A. 2C:28-1 et seq., specifically, N.J.S.A. 2C:28-3, within the New Jersey Code of Criminal Justice.

Dated: _____ Signature: _____

Title: _____



CONFIDENTIALITY AND COMMITMENT TO DEFEND

STATE OF NEW JERSEY
DEPARTMENT OF THE TREASURY - DIVISION OF PURCHASE AND PROPERTY
33 WEST STATE STREET, P.O. BOX 230 TRENTON, NEW JERSEY 08625-0230

BID SOLICITATION # & TITLE: _____

The Bid Solicitation advises Bidders (hereinafter "Company") that the submitted "Quotes can be released to the public pursuant to N.J.A.C. 17:12-1.2(b) and (c), or under the New Jersey Open Public Records Act (OPRA), N.J.S.A. 47:1A-1.1 et seq., or the common law right to know." In the event that the Division receives a request for documents related to above referenced Bid Solicitation, in accordance with its statutory obligations under the New Jersey Open Public Records Act and/or the common law right to know, it is the Division's intent to fulfill the request for records which may include a copy of the Company's Quote.

If Company objects to the disclosure of any portions of the Quote, the Company must advise the Division and must attach a detailed statement clearly identifying those sections of the Quote that Company claims are exempt from disclosure. In requesting any exemption, Company must identify the specific statutory or other legal justification for each requested exemption and the factual basis that supports said exemption. In addition, if Company requests any exemption to disclosure of the Quote based upon claims of confidential/proprietary information and trade secrets (setting forth the nature of the formula, process, pattern, device or compilation), in accordance with *Ingersoll-Rand Co. v. Ciavatta*, 110 N.J. 609 (1988), Company must also indicate the following with respect to the requested exemption:

- (1) the extent to which the information is known outside the owner's business;
- (2) the extent to which it is known by employees and others involved with your business;
- (3) the extent of the measures taken by your firm to guard the secrecy of the information;
- (4) the value of the information to your firm and your competitors;
- (5) the amount of effort or money expended by your firm in developing the information; and
- (6) the ease or difficulty with which the information could be properly acquired or duplicated by others.

Further, if the Quote includes any copyright notices, within five business days, the Division will be permitted to release a copy of the Quote document(s) unless Company serves the Division with an order from a court of competent jurisdiction precluding such release.

The State reserves the right to make the final determination as to what is and is not subject to public disclosure under OPRA and/or the common law right to know, and will advise the Company accordingly. Please note that the State will not honor any claim of confidential, proprietary, trade secret, and/or copyright material that is not supported by a specific statutory or legal justification provided by the Company. The State will not honor any attempts by the Company to designate the entire Quote as proprietary, confidential and/or to claim copyright protection for its entire Quote.

Accordingly, in order to assist the Division with the fulfillment of potential document requests, please select **one** of the following:

The Company's Quote **does not include** any confidential, proprietary and/or trade secrets; and therefore, the Company does not request any redactions be made prior to the release of the documents.

OR

The Company's Quote **does include** confidential, proprietary and/or trade secrets; and therefore, the Company requests that certain portions of the Quote be redacted prior to the release of the documents.

The requested redactions are set forth in the attached statement which specifically identifies the portions of the Quote by section, page number, paragraph and or line; and identifies the specific statutory or other legal reason for each requested exemption.

In the event of any challenge to the Company's assertion of confidential/proprietary information, the Company shall be solely responsible for defending its designation. Company agrees that it shall defend and cooperate in the defense of an action against the State of New Jersey arising from or related to the non-disclosure, due to the Company's request, of documents submitted to the State of New Jersey, and relating to a Quote submitted by the Company in response to the above referenced Bid Solicitation, which was the subject of a request for government records under the New Jersey Open Public Records Act, N.J.S.A. 47:1A-1 et seq. ("OPRA"), or the common law right to know. The Company further agrees to indemnify and hold harmless the State against any judgments, costs, or attorneys' fees assessed against the State in connection with any action arising from, or related to, the non-disclosure, due to the Company's request, of documents submitted to the State, which are the subject of a request for government records under OPRA.

The Company makes the forgoing agreement with the understanding that the State may immediately disclose any documents withheld without further notice if the Company ceases to cooperate in the defense of an action against the State arising from or related to the above described non-disclosure due to the Company's request, and will disclose such documents withheld if so ordered by a court of competent jurisdiction.

The undersigned certifies that s/he is duly authorized to make this commitment on behalf of the Company.

Company Name

Signature

Date

Print Name and Title



DISCLOSURE OF INVESTIGATIONS AND OTHER ACTIONS INVOLVING THE VENDOR FORM

Q28

STATE OF NEW JERSEY
DEPARTMENT OF THE TREASURY - DIVISION OF PURCHASE AND PROPERTY
33 WEST STATE STREET, P.O. BOX 230 TRENTON, NEW JERSEY 08625-0230

BID SOLICITATION # AND TITLE: _____

VENDOR NAME: _____

PART 1
PLEASE LIST ALL OFFICERS/DIRECTORS OF THE VENDOR BELOW.

Form with fields: NAME, TITLE, ADDRESS, ADDRESS, CITY, STATE, ZIP

Form with fields: NAME, TITLE, ADDRESS, ADDRESS, CITY, STATE, ZIP

Form with fields: NAME, TITLE, ADDRESS, ADDRESS, CITY, STATE, ZIP

Form with fields: NAME, TITLE, ADDRESS, ADDRESS, CITY, STATE, ZIP

*Attach Additional Sheets If Necessary.

PART 2
PLEASE REFER TO THE PERSONS LISTED ABOVE AND/OR THE PERSONS AND/OR ENTITIES LISTED ON THE OWNERSHIP DISCLOSURE FORM WHEN ANSWERING THESE QUESTIONS.

- 1. Has any person or entity listed on this form or its attachments ever been arrested, charged, indicted, or convicted in a criminal or disorderly persons matter by the State of New Jersey...
2. Has any person or entity listed on this form or its attachments ever been suspended, debarred or otherwise declared ineligible...
3. Are there currently any pending criminal matters or debarment proceedings...
4. Has any person or entity listed on this form or its attachments been denied any license, permit or similar authorization...
5. Has any person or entity listed on this form or its attachments been involved as an adverse party to a public sector client...

IF ANY OF THE ANSWERS TO QUESTIONS 1-5 ARE "YES", PLEASE PROVIDE THE REQUESTED INFORMATION IN PART 3.
IF ALL OF THE ANSWERS TO QUESTIONS 1-5 ARE "NO", NO FURTHER ACTION IS NEEDED; PLEASE SIGN AND DATE THE FORM.

PART 3
DESCRIPTION OF THE INVESTIGATION OR LITIGATION, ETC.

If you answered "YES" to any of questions 1 - 5 above, you must provide a detailed description of any investigation or litigation, including, but not limited to, administrative complaints or other administrative proceedings involving public sector clients during the past five (5) years.

Form with fields: PERSON OR ENTITY NAME, CONTACT NAME, PHONE NUMBER, CASE CAPTION, INCEPTION OF THE INVESTIGATION, CURRENT STATUS, SUMMARY OF INVESTIGATION

*Attach Additional Sheets If Necessary.

CERTIFICATION

I, the undersigned, certify that I am authorized to execute this certification on behalf of the Vendor, that the foregoing information and any attachments hereto, to the best of my knowledge are true and complete. I acknowledge that the State of New Jersey is relying on the information contained herein...

Signature _____

Date _____

Print Name and Title _____



MACBRIDE PRINCIPLES FORM

Q29

STATE OF NEW JERSEY
DEPARTMENT OF THE TREASURY - DIVISION OF PURCHASE AND PROPERTY
33 WEST STATE STREET, P.O. BOX 230 TRENTON, NEW JERSEY 08625-0230

BID SOLICITATION # AND TITLE: _____

VENDOR NAME: _____

Pursuant to Public Law 1995, c. 134, a responsible Vendor/Bidder is required to provide a certification in compliance with the MacBride Principles and Northern Ireland Act of 1989. Pursuant to N.J.S.A. 52:34-12.2, Vendor/Bidder must complete the certification below by checking one of the two options listed below and signing where indicated. If a Vendor/Bidder that would otherwise be awarded a purchase, contract or agreement does not complete the certification, then the Director may determine, in accordance with applicable law and rules, that it is in the best interest of the State to award the purchase, contract or agreement to another Vendor/Bidder that has completed the certification and has submitted a bid within five (5) percent of the most advantageous bid. If the Director finds contractors to be in violation of the principles that are the subject of this law, he/she shall take such action as may be appropriate and provided by law, rule or contract, including but not limited to, imposing sanctions, seeking compliance, recovering damages, declaring the party in default and seeking debarment or suspension of the party.

I, the undersigned, on behalf the Vendor/Bidder, certify pursuant to N.J.S.A. 52:34-12.2 that:

CHECK THE APPROPRIATE BOX

The Vendor/Bidder has no business operations in Northern Ireland; or

OR

The Vendor/Bidder will take lawful steps in good faith to conduct any business operations it has in Northern Ireland in accordance with the MacBride principles of nondiscrimination in employment as set forth in section 2 of P.L. 1987, c. 177 (N.J.S.A. 52:18A-89.5) and in conformance with the United Kingdom's Fair Employment (Northern Ireland) Act of 1989, and permit independent monitoring of its compliance with those principles.

CERTIFICATION

I, the undersigned, certify that I am authorized to execute this certification on behalf of the Vendor, that the foregoing information and any attachments hereto, to the best of my knowledge are true and complete. I acknowledge that the State of New Jersey is relying on the information contained herein, and that the Vendor is under a continuing obligation from the date of this certification through the completion of any contract(s) with the State to notify the State in writing of any changes to the information contained herein; that I am aware that it is a criminal offense to make a false statement or misrepresentation in this certification. If I do so, I may be subject to criminal prosecution under the law, and it will constitute a material breach of my contract(s) with the State, permitting the State to declare any contract(s) resulting from this certification void and unenforceable.

Signature

Date

Print Name and Title

GENERAL CONDITIONS
Table of Contents

ARTICLE	Page
GENERAL INFORMATION	6
1. GENERAL	6
2. ABBREVIATIONS	6
3. DEFINITIONS	7
4. RESERVED	15
5. RESERVED	15
BIDDING REQUIREMENTS AND CONDITIONS	15
6. INQUIRIES REGARDING THE PROJECT	15
7. PREQUALIFICATION OF PROSPECTIVE BIDDERS	15
8. DISQUALIFICATION OF PREQUALIFIED PROSPECTIVE BIDDERS	16
9. CONTENTS OF THE PROPOSAL	16
10. INTERPRETATION OF QUANTITIES IN BID FORM	16
11. "IF AND WHERE DIRECTED" ITEMS	17
12. EXAMINATION OF CONTRACT DOCUMENTS AND SITE OF PROJECT	17
13. PREPARATION OF PROPOSAL	19
14. BALANCED BIDS	20
15. DELIVERY OF PROPOSALS	20
16. BID SECURITY	21
17. WITHDRAWAL OF PROPOSALS	21
18. COMBINATION OR CONDITIONAL PROPOSALS	21
19. ACKNOWLEDGEMENT OF REVISIONS	21
20. PUBLIC OPENING OF PROPOSALS	22
21. IRREGULAR PROPOSALS	22
22. DISQUALIFICATION OF BIDDERS	22
23. RESERVED	23
24. RESERVED	23
AWARD AND EXECUTION OF CONTRACT	23
25. CONSIDERATION OF PROPOSALS/BID DISCREPANCIES	23
26. AWARD OF CONTRACT	23
27. CANCELLATION OF AWARD	24
28. RETURN OF PROPOSAL BOND	24
29. EXECUTION AND APPROVAL OF CONTRACT	25
30. PERFORMANCE BOND AND PAYMENT BOND	25
31. FAILURE TO EXECUTE CONTRACT	25
32. RESERVED	25
33. RESERVED	25
SCOPE OF WORK	26
34. INTENT	26
35. CHANGES	26
36. MINOR CHANGES IN THE WORK	27
37. PROCEDURE AND PROTEST	27
38. INCREASED OR DECREASED QUANTITIES	28
39. ELIMINATED ITEMS	29
40. DIFFERING SITE CONDITIONS	30
41. CHANGES IN CHARACTER OF WORK	30

42. EXTRA WORK	31
43. NOTIFICATION OF CHANGES	31
44. RIGHTS IN AND USE OF MATERIALS FOUND ON THE WORK	33
45. MAINTENANCE OF TRAFFIC.....	33
46. VALUE ENGINEERING	34
47. FINAL CLEANUP	37
48. RESERVED	37
49. RESERVED	37
CONTROL OF WORK	37
50. COMMUNICATIONS	37
51. THE OWNER'S PROJECT ADMINISTRATION	37
52. OWNER OF THE ENGINEER	37
53. DUTIES AND RESPONSIBILITIES OF THE ENGINEER.....	38
54. INSPECTORS.....	39
55. INSPECTION BY CONTRACTOR.....	39
56. INSPECTION OF WORK.....	39
57. QUALITY CONTROL & QUALITY ASSURANCE TESTING.....	40
58. SPECIAL INSPECTION, TESTING, OR APPROVAL	40
59. CONFORMITY WITH CONTRACT DOCUMENTS.....	41
60. EXAMINATION OF QUESTIONED WORK.....	41
61. UNNOTICED DEFECTS.....	41
62. REMOVAL OF UNACCEPTABLE AND UNAUTHORIZED WORK.....	42
63. RIGHT TO RETAIN DEFECTIVE WORK	42
64. LATENT DEFECTS	42
65. PROJECT MEETINGS	42
66. INDEPENDENT CONTRACTOR.....	42
67. SUPERINTENDENCE	42
68. RECEPTION OF ENGINEER'S DIRECTIONS.....	43
69. ACCESS TO WORK.....	43
70. AUTOMATICALLY CONTROLLED EQUIPMENT	43
71. LOAD RESTRICTIONS	43
72. MAINTENANCE DURING CONSTRUCTION	44
73. FAILURE TO MAINTAIN ROADWAY	45
74. CONSTRUCTION STAKES, LINES, AND GRADES	45
75. COOPERATION BY CONTRACTOR	46
76. COOPERATION BETWEEN CONTRACTORS.....	46
77. COOPERATION WITH UTILITIES	47
78. SAFETY	50
79. PROTECTION OF WORK AND PROPERTY AND SECURITY.....	51
80. RESPONSIBILITY OF CONTRACTOR TO ACT IN EMERGENCY.....	52
81. PARTIAL ACCEPTANCE	52
82. SUBSTANTIAL COMPLETION DATE	52
83. COMPLETION AND ACCEPTANCE	53
84. RESERVED	54
85. RESERVED	54
CONTRACT DOCUMENTS.....	54
86. PLANS AND SPECIFICATIONS.....	54
87. ADDITIONAL CONTRACT DOCUMENTS	54
88. SUPPLEMENTING DRAWINGS, INSTRUCTIONS, WORKING DRAWINGS AND CATALOG CUTS	54

89. DISCREPANCIES AND OMISSIONS	56
90. VERIFICATION AND WARRANTY	56
91. DOCUMENTS TO BE KEPT ON THE JOBSITE	57
92. OWNERSHIP OF CONTRACT DOCUMENTS	57
93. RESERVED	57
94. RESERVED	57
CONTROL OF MATERIAL	57
95. SOURCE OF SUPPLY AND QUALITY REQUIREMENTS	57
96. LOCAL MATERIAL SOURCES	58
97. SUBMITTALS	58
98. RELEASE OF BITUMINOUS AND CEMENT CONCRETE	58
99. MATERIALS, INSPECTIONS, TESTS, AND SAMPLES	59
100. PERFORMANCE TESTING	60
101. CERTIFICATION OF COMPLIANCE	60
102. PLANT INSPECTION	61
103. CONTRACTORS' AND MANUFACTURERS' COMPLIANCE WITH STATE SAFETY, OSHA, AND OTHER CODE REQUIREMENTS	61
104. STORAGE AND HANDLING OF MATERIALS	62
105. UNACCEPTABLE MATERIALS	62
106. OWNER FURNISHED MATERIAL	62
107. SUBSTITUTES OR "OR EQUAL" ITEMS	62
108. GUARANTEE	64
109. CORRECTION OF DEFECTIVE WORK AFTER CONTRACT COMPLETION	64
110. RESERVED	65
111. RESERVED	65
LEGAL RELATIONS AND RESPONSIBILITY TO PUBLIC	65
112. GOVERNING LAW	65
113. APPLICABLE LAWS	65
114. PERMITS AND LICENSES	65
115. RESTORATION OF SURFACES OPENED BY PERMIT	66
116. FEDERAL AID PARTICIPATION	67
117. ENVIRONMENTAL PROTECTION	67
118. ARCHAEOLOGICAL AND HISTORICAL FINDINGS	69
119. TAXES AND CHARGES	69
120. COMPLIANCE WITH LABOR STANDARDS AND RATE OF WAGE REQUIREMENTS	69
121. ROYALTIES, PATENTED DEVICES, MATERIALS, AND PROCESSES	70
122. SANITARY, HEALTH, AND SAFETY PROVISIONS	70
123. PUBLIC CONVENIENCE AND SAFETY	71
124. RAILWAY HIGHWAY PROVISIONS	71
125. CONSTRUCTION OVER OR ADJACENT TO NAVIGABLE WATERS	72
126. BARRICADES, WARNING SIGNS AND HAZARD MARKINGS	72
127. USE OF EXPLOSIVES	72
128. PROTECTION AND RESTORATION OF PROPERTY MARKERS AND LAND MONUMENTS	73
129. FOREST PROTECTION	73
130. OPENING SECTIONS OF PROJECT TO TRAFFIC	73
131. INDEPENDENT CONTRACTOR	74
132. THIRD PARTY BENEFICIARY CLAUSE	74
133. LIMITATIONS OF LIABILITY	74
134. ASSIGNMENT OF CONTRACT FUNDS AND CLAIMS	74
135. RISK ASSUMED BY THE CONTRACTOR	74
136. DISPUTES	76
137. ARBITRATION	77

138. HEADINGS	77
139. RESERVED	77
140. RESERVED	77
MAINTENANCE BOND, INSURANCE, AND INDEMNIFICATION	77
141. MAINTENANCE BOND	77
142. DEFAULT OF SURETY	77
143. INSURANCE AND LIABILITY	78
PROSECUTION AND PROGRESS OF THE WORK.....	83
144. ASSIGNMENT	83
145. SUBCONTRACTING	83
146. OTHER CONTRACTS	84
147. COMMENCEMENT OF WORK	85
148. PROSECUTION OF THE WORK	85
149. LIMITATION OF OPERATIONS	85
150. CHARACTER OF WORKERS	86
151. CONTRACTOR'S METHODS, TOOLS AND EQUIPMENT	86
152. OWNER'S RIGHT TO CORRECT DEFECTIVE WORK	87
153. WORKING SITE / USE OF PREMISES	87
154. UNUSUAL SITE CONDITIONS	88
155. COMPLAINTS	88
156. TEMPORARY SUSPENSION OF WORK	89
157. SUSPENSION OF WORK	89
158. TERMINATION FOR DEFAULT, DAMAGES FOR DELAY, TIME EXTENSIONS	90
159. CLAIMS FOR ADDITIONAL TIME AND/OR COMPENSATION	91
160. TERMINATION FOR CONVENIENCE	91
161. OWNER'S USE OF PORTIONS OF THE WORK	94
162. TIME OF COMPLETION	95
163. LIQUIDATED DAMAGES OR ACTUAL DAMAGES FOR DELAY	95
164. RESERVED	96
165. RESERVED	96
PROGRESS SCHEDULE	96
166. GENERAL	96
167. PROCEDURES	99
168. CONTENT AND PROJECT SCHEDULE	101
169. SCHEDULE REVIEW MEETINGS	103
170. UPDATING	103
171. SUBMITTALS	104
172. RECOVERY SCHEDULE	105
173. EXTENSION OF TIME	106
174. DRAWINGS	108
175. SUBMISSION LOG	109
176. MEASUREMENT AND PAYMENT	109
177. RESERVED	110
178. RESERVED	110
PAYMENT	110
179. PAYMENT FOR MODIFICATIONS	110
180. PAYMENT FOR CONTRACTOR'S EXPENSES DURING DELAYS	117
181. PARTIAL PAYMENTS	119
182. RELEASE OF LIENS OR CLAIMS	121
183. FINAL PAYMENT	121

184. NO WAIVER OF RIGHTS 122
185. ACCEPTANCE OF FINAL PAYMENT CONSTITUTES RELEASE 122
186. AUDIT: ACCESS TO RECORDS 122
187. RESERVED **Error! Bookmark not defined.**
188. RESERVED **Error! Bookmark not defined.**

GENERAL INFORMATION

1. GENERAL

These GENERAL CONDITIONS contain contractual-legal Articles that establish the requirements and conditions governing responsibility, policy and procedures that apply during the Contract and guarantee period. Any revisions, additions, or deletions to the following Articles that are special to the work under this Contract will be made in the SUPPLEMENTARY CONDITIONS. Additional requirements and conditions that have special significance to the Contract for the work are as set forth elsewhere in these Contract Documents.

2. ABBREVIATIONS

AAN	American Association of Nurserymen
AAR	Association of American Railroads
AASHTO	American Association of State Highway and Transportation Officials
ACI	American Concrete Institute
AGC	Association of General Contractors of America
AI	Asphalt Institute
AIA	American Institute of Architects
AIP	Airport Improvement Program
AISC	American Institute of Steel Construction
AISI	American Iron and Steel Institute
ANG	Air National Guard
ANSI	American National Standards Institute
AOA	Airport Operations Area
API	American Petroleum Institute
ARA	American Railway Association
AREA	American Railway Engineering Association
ARTBA	American Road and Transportation Builders Association
ASCE	American Society of Civil Engineers
ASLA	American Society of Landscape Architects
ASME	American Society of Mechanical Engineers
ASTM	American Society for Testing and Materials
AWG	American Wire Gage
AWPA	American Wood Preservers Association
AWS	American Welding Society
AWWA	American Water Works Association
B&S	Bown & Sharpe Wire Gage
CFR	Code of Federal Regulation
CIAP	Construction Industry Advancement Program of New Jersey
CRSI	Concrete Reinforcing Steel Institute
CTC	Concrete Technology Corporation
EEl	Edison Electrical Institute
EPA	Environmental Protection Agency of the United States Government
FAA	Federal Aviation Administration
FAR	Federal Aviation Regulations
FHWA	Federal Highway Administration
FSS	Federal Specifications and Standards, General Services Administration
ICEA	Insulated Cable Engineers Association
IEEE	Institute of Electrical and Electronic Engineers
IES	Illuminating Engineering Society
IMSA	International Municipal Signal Association
ISO	International Organization for Standardization

ITE	Institute of Transportation Engineers
MIL	Military Specifications
MUTCD	Manual on Uniform Traffic Control Devices (FHWA)
NBFU	National Board of Fire Underwriters
NCSA	National Crushed Stone Association
NEC	National Electric Code
NELA	National Electrical Light Association
NEMA	National Electrical Manufacturers Association
NESC	National Electrical Code
NFPA	National Fire Prevention Association
NIST	National Institute for Standards and Technology
NJAC	New Jersey Administrative Code
NJANG	New Jersey Air National Guard
NJDEP	New Jersey Department of Environmental Protection
NJDOT	New Jersey Department of Transportation
NOAA	National Oceanic and Atmospheric Administration
NOTAM	Notice to Airman
OSHA	Occupational Safety and Health Administration
PCA	Portland Cement Association
PCI	Pre-stressed Concrete Institute
PEI	Porcelain Enamel Institute, Incorporated
SAE	Society of Automotive Engineers
SI	International System of Units
SRL	Skid Resistance Level
SSPC	Steel Structures Painting Council
UL	Underwriter's Laboratories
UNC	Unified National Coarse
USACE	United States Army Corps of Engineers
USCG	United States Coast Guard
USSWG	United States Steel Wire Gage

3. DEFINITIONS

Wherever in the Contract Documents the following terms are used, the intent and meaning shall be interpreted as stated below.

ACCEPTANCE -The term "Acceptance" means the formal written acceptance of the Project by the South Jersey Port Corporation, which has been completed in all respects, including changes, in accordance with the Contract Documents.

ADDENDA (Addenda or Addendum used interchangeably) - The term "Addenda" means the written and/or graphic documents and/or computer disk issued prior to the opening of bids, which clarify, correct, or change the Contract Documents.

ADDITIONAL WORK - Work, of a type already provided by the contract and for which the contract has established a unit price under a Pay Item.

ADVERTISEMENT - The public announcement, as required by law, inviting bids for work to be performed or materials to be furnished.

AIR TEMPERATURE - The measured temperature, in the shade, not in the direct rays of the sun, and away from artificial heat.

ARCHITECT – “Architect” shall mean the Chief Engineer’s duly authorized representative(s), such representative(s) acting within the scope of the particular duties delegated to him or the firm designated in the Contract Documents as Architect for the project, with its associated consultants, or their duly authorized representatives or agents, such firm being the authorized representative of the Owner, acting directly for the Owner. The Architect is referred to throughout the Contract Documents as if singular in number and masculine in gender.

AS APPROVED - The words "as approved," unless otherwise qualified, shall be understood to be followed by the words "by the Engineer."

AS SHOWN, AS INDICATED, AND AS SPECIFIED - The words "as shown," "as indicated" or "as specified" shall be understood to be followed by the words "in the Contract Documents."

OWNER - The term "Owner" means the SOUTH JERSEY PORT CORPORATION of the State of New Jersey, as created by law acting through its Executive Director or his duly authorized representative. Throughout the Contract Documents the Owner is referred to as singular in number and masculine in gender.

OWNER’S REPRESENTATIVE - “Owner’s Representative” shall mean the firms or individuals designated in the Contract Documents as Engineer or Construction Manager for the project, with associated consultants, or their duly authorized representatives or agent, such firms or individuals being the authorized representatives of the Owner, acting directly for the Owner. The Owner’s Representative is referred to throughout the Contract Documents as if singular in number and masculine in gender.

AWARD - The term "Award" means the decision of the Owner to accept the Proposal of the lowest responsible Bidder, subject to the execution and approval of a satisfactory Contract based thereon and bonds to secure the performance thereof, and such conditions as may hereinafter be specified or as may be specified or required by law.

BID FORM - The term "Bid Form" means the approved form furnished by the Owner on which the Owner requires bids to be prepared and submitted for the Work.

BID SECURITY - The term “Bid Security” means the security furnished with a bid to guarantee that the Bidder shall enter into the Contract if awarded the Contract.

BIDDER - The term "Bidder" means an individual, firm, partnership, corporation, or any acceptable combination thereof, acting directly or through a duly authorized representative, legally submitting a bid for the advertised work defined in the Contract Documents.

BRIDGE - A structure, including supports, spanning and providing passage over a waterway, a railroad, a highway, or other obstruction; more than 20 feet long, measured along the center of the roadway or railroad, between faces of abutments. In the case of boxes or arches, the length is measured between the face of the sidewalls and, in the case of multiple boxes, between the inside faces of the outside walls.

BUSINESS ENTITY – The term “Business Entity” means any natural or legal person, business corporation, professional services corporation, limited liability company, partnership, limited partnership, business trust, association of any other legal commercial entity organized under the laws of New Jersey or any other state or foreign jurisdiction. It also includes (i) all principals who own or control more than 10 percent of the profits or assets of a business entity or 10 percent of the stock in the case of a business entity that is a corporation for profit, as appropriate; (ii) any subsidiaries directly or indirectly controlled by the business entity; (iii) any political organization under 26 U.S.C.A. 527 that is directly and indirectly controlled by the business entity, other than a

candidate committee, election fund or political party committee; and (iv) if a business entity is a natural person, that person's spouse or child, residing in the same household.

BY OTHERS - The term "by others" refers to a person, firm, or corporation other than the Contractor or its surety including persons, firms, or corporations in a contractual relationship with the Contractor or its surety, such as a Subcontractor, supplier, fabricator, or consultant at any tier. "By others" shall include the Owner or other public body.

CALENDAR DAY - Each and every day shown on the calendar.

CLAIM - A "claim" is a written statement requesting additional time and/or money for acts or omissions during the performance of the Contract. The Contractor must set forth the facts and circumstances for which the Owner or Engineer is responsible in order to be entitled to additional compensation and/or time.

COMPLETION - The term "Completion" means Completion of the Work. Completion shall occur when:

1. the Work has been satisfactorily completed in all respects in accordance with the Contract Documents;
2. the Project is ready for use by the Owner to the degree required by the terms of the Contract, and;
3. the Contractor has satisfactorily executed and delivered to the Engineer all documents, certificates, and proofs of compliance required by the Contract Documents, it being understood that the satisfactory execution and delivery of said documents, certificates, and proofs of compliance is a requirement of the Contract.

CONTRACT DOCUMENTS - The "Contract Documents" consist of the Bidder's completed Proposal Section, Project Manual, the Plans, all Addenda issued prior to the opening of Bids and all Contract Modifications or Change Orders issued after execution of the Contract. This Contract represents the entire and integrated agreement between the parties hereto and supersedes all prior negotiations, representations, or agreements, either written or oral. The Contract may be amended or modified only by a Contract Modification as defined in Articles "CHANGES," "DIFFERING SITE CONDITIONS" and "SUSPENSION OF WORK" of these GENERAL CONDITIONS. The Contract Documents shall not be construed to create any contractual relationship of any kind between the Engineer and the Contractor.

CONSTRUCTION MANAGER - "Construction Manager" shall mean the firm or individuals designated in the Contract Documents as the construction manager for the project, with associated consultants, or their duly authorized representative or agent, such firm being the authorized representatives of the Owner acting directly for the Owner. The Construction Manager is referred to throughout the Contract Documents as if singular in number and masculine in gender.

CONSTRUCTION OPERATIONS - Construction operations shall include site clearing, demolition, movement of utilities or other facilities, and actual construction of any of the temporary or permanent structures, roadways, or public improvements required by the Contract. The term shall not include mobilization, procurement and storage of materials and plants, providing engineering, Performance Bond and Payment Bond, surveys, working drawings, field offices, or other schedules, certificates, forms, or documents necessary prior to the performance of Work on Pay Items.

CONTRACT - The term "Contract" means the entire and integrated agreement between the parties thereunder and supersedes all prior negotiations, representations, or agreements, either written or oral. The Contract Documents form the Contract between the Owner and the Contractor setting

forth the obligations of the parties thereunder, including, but not limited to, the performance of the Work and the basis of payment.

CONTRACT COMPLETION - The "Contract Completion" is the date the Owner accepts the entire work as being in compliance with the Contract Documents, or formally waives nonconforming work to the extent of the nonconformity, and issues the final payment in accordance with the requirements set forth in Article "FINAL PAYMENT" of these GENERAL CONDITIONS.

CONTRACT MODIFICATIONS - "Contract Modifications" shall mean any written alteration to the specifications, delivery point, rate of delivery, contract period, price, quantity or other contract provision of an existing contract, whether accomplished by unilateral action in accordance with a contract provision, or by mutual action of the parties to the Contract and includes, but is not limited to, changes in the work, differing site conditions, delays in performance, suspensions of work, and acceleration of performance.

CONTRACT TIME - The term "Contract Time" means the number of working days or calendar days including authorized adjustments allowed for Completion. When a specified completion date is shown in the Specifications in lieu of the number of working or calendar days, Completion shall be on or before that date. Specified completion date and calendar day contracts shall be completed on or before the day indicated even when that date is a Saturday, Sunday, or holiday.

CONTRACTOR - The term "Contractor" means the individual, firm, partnership, corporation, or any acceptable combination thereof contracting with the Owner for performance of the prescribed Work. Throughout the Contract Documents, the Contractor is referred to as if singular in number and masculine in gender. The term "Contractor" means the Contractor or the Contractor's authorized representative.

CONTRIBUTION – The term "Contribution" means a contribution reportable as a recipient under "The New Jersey Campaign Contributions and Expenditures Reporting Act." P.L. 1973, c.83 (C.10:44A-1 et seq.), and implementing regulations set forth at N.J.A.C. 19:25-7 and N.J.A.C. 19:25-10.1 et seq. As of January 1, 2005, contributions in excess of \$300.00 during a reporting period are deemed "reportable" under these laws.

CROSS SECTIONS - Graphic representation of the ground elevations of the ground or other improvements taken at various intervals during the contract at right angles to the centerline or base line.

CULVERT - Any enclosed Structure, not classified as a bridge, which provides an opening under the roadway, runway, taxiway, or ground surface for the purpose of conveying storm water runoff.

DAYS - Unless otherwise designated, days as used in the Contract Documents means calendar days.

DEFECTIVE WORK - "Defective Work" is work that (i) is unsatisfactory, faulty, or deficient; (ii) does not conform to the Contract Documents; (iii) does not meet the requirements of any inspection, test, or approval referred to in the Contract Documents; (iv) has been damaged prior to the Engineer's recommendation for final payment; or (v) does not conform to generally accepted standards of workmanship.

DISPUTE - A disagreement between the Owner and the Contractor with regard to the Work or Contract Documents.

DRAWINGS - See "PLANS"

ENGINEER - "Engineer" shall mean the Owner's Director of Engineering or his/her duly authorized representatives, such representatives acting within the scope of the particular duties delegated to him or the firm designated in the Contract Documents as Engineer for the project, with its associated consultants, or their duly authorized representatives or agent, such firm being the authorized representatives of the Owner, acting directly for the Owner. The Engineer is referred to throughout the Contract Documents as if singular in number and masculine in gender.

EQUIPMENT - All machinery and equipment, together with the necessary supplies for upkeep and maintenance, and also tools and apparatus necessary for the proper construction of the Work.

EXECUTION OF CONTRACT - "Execution of Contract," or equivalent words, shall mean the signing of the Contract by the jurisdictional representatives of both the Owner and the Contractor.

EXTRA WORK - The term "Extra Work" means new and unforeseen work found essential to the satisfactory completion of the Project, as determined by the Engineer, and not covered by any of the various Pay Items for which there is a bid price or by combination of such items. In the event portions of such work are determined by the Engineer to be covered by one (1) of the various Pay Items for which there is a bid price or combinations of such items, the remaining portion of such work will be designated as Extra Work. Extra Work also includes work specifically designated as Extra Work in the Contract Documents.

FABRICATOR - A firm, company, or individual supplying fabricated material for the Project.

FIELD ORDER - The term "Field Order" means a written order, signed by the Engineer, requiring performance by the Contractor without negotiation of any sort.

GRADE LINE - The profile of the finished roadway, runway or taxiway surface along the proposed construction centerline or base line.

INSPECTOR - The Engineer's authorized representative assigned to inspect contract performance, methods, and materials related to the Work both on and off the site of the Project.

IN WRITING - Communication between parties delivered or sent, and received, in the form of a written letter, telegram, or mailgram.

JOBSITE - "Jobsite" shall mean the area upon or in which the Contractor's operations are carried on and such other areas adjacent thereto as may be designated as such by the Engineer.

LATENT DEFECT - The term "Latent Defect" means a defect that is present or potential but is not evident or active.

LAW - "Law" shall mean any Federal, State, or local law, statute, ordinance, rule, regulation or code.

LOT - An isolated quantity of specified material from a single source, or a measured amount of specified construction, to be produced by the same process.

MAJOR AND MINOR PAY ITEMS - The term "Major Pay Item" means any Pay Item having an original Contract value equal to or in excess of 10 percent (20 percent for Port Improvement Program projects) of the total amount of the award contract. The original Contract value of a Pay Item equals the per unit price bid for said Pay Item multiplied by the estimated quantity of such item contained in the Proposal Form. All other Pay Items shall be considered "Minor Pay Items."

MANUFACTURER - A firm, company, or individual manufacturing material for the project.

MARINE TERMINAL OPERATIONS AREA – The term “marine terminal operations area” shall mean any area of the marine terminal used or intended to be used for the docking, loading, or unloading of ships. An marine terminal operations area shall include such paved or unpaved areas that are used or intended to be used for the unobstructed movement of ships and cargo handling vehicles in addition to its associated paving, sheds, and warehouses. Only persons with security clearance who are properly credentialed shall have access to the marine terminal operations area.

MATERIALS - Any substances specified for use in the construction of the Project.

MODIFICATION ORDER - "Modification Order" shall mean a written order, which carries out a Contract Modification.

MULTIPLE DEFICIENCY - Deficiency in more than one (1) characteristic within the same lot.

NOTICE - The term "notice" or the requirement to notify, means a written communication delivered in person or by certified or registered mail (receipt required) to the person for whom it is intended. Certified or registered mail shall be addressed to that last known business address of the intended recipient.

NOTICE TO PROCEED - The term "Notice to Proceed" means the written notice to the Contractor to begin Work.

OR EQUAL - The term "or equal" shall be understood to indicate that the "equal" product is the same or better than the product named in the Specifications in the function, performance, reliability, quality, and general configuration in accordance with Article "SUBSTITUTES OR "OR EQUAL" ITEMS" of these GENERAL CONDITIONS.

OWNER - The term “Owner” means the South Jersey Port Corporation of the State of New Jersey, as created by law acting through its Executive Director or his duly authorized representative. Throughout the Contract Documents, the Owner is referred to as singular in number and masculine in gender.

PAY ITEM (CONTRACT ITEM) - The term "Pay Item" means a specifically described item of Work for which the Bidder provides a per-unit or lump-sum price in the Proposal.

PAYMENT BOND - The approved form of security, furnished by the Contractor and the surety, as a guarantee to pay promptly, or cause to be paid promptly, in full, such as may be due for all material furnished, labor supplied or performed, rental or equipment used, and services rendered by public utilities in, or in connection with, the work under contract.

PERFORMANCE BOND - The term "Performance Bond" means the approved form of security, furnished by the Contractor and the surety, as a guarantee on part of the Contractor to execute the work, in accordance with the terms of the specifications and contract.

PLANS - The term "Plans" means the sealed plan, profiles, cross sections, elevations, details, and other working drawings, supplemental drawings, all adjustments made to the plans in Addenda or by Modification Order, or reproductions thereof, signed by the Engineer and accepted by the Owner; and which show the location, character, dimensions, and details of the work to be performed.

PRECONSTRUCTION CONFERENCE - The initial Project meeting conducted by the Engineer, normally held after Award of the Contract and prior to the start of Work. A separate utility

preconstruction conference may be scheduled. The Contractor shall attend preconstruction conferences.

PROFILE - The trace of a vertical plane intersecting the top surface of the proposed improvement surface, usually along the longitudinal centerline. Profile grade means either the elevation or gradient of such trace according to the context. From this, cross-section elevations are established based on the typical section.

PROJECT - The specific section of Port, highway or other public improvement together with all appurtenances and construction to be performed thereon, under the Contract. The Project may include work by others under other contracts.

PROJECT MANUAL - The term project manual shall be synonymous with the term specifications as defined herein.

PROPOSAL - The term "Proposal" means the offer of a Bidder, properly signed and guaranteed, on the prepared form furnished by the Owner to perform the Work at the prices therein.

PROPOSAL FORM - The term "Proposal Form" means the approved form furnished by the Owner on which the Owner requires bids to be prepared and submitted for the Work.

REGISTRATION - The term "Registration" means the process by which any business can have its eligibility for participation in the New Jersey Commerce and Economic Growth Commission's small business programs determined.

RESIDENT ENGINEER - The term "Resident Engineer" means the field representative of the Engineer having direct supervision of the administration of the Contract and all work.

SHALL - Designates an obligation to perform the specified the specified directive, unless otherwise indicated.

SMALL BUSINESS ENTERPRISE - For a **goods and services Contractor**, the term "Small Business Enterprise" shall mean a business certified by the State of New Jersey to qualify as a business which has its principal place of business in the State, is independently owned and operated, has no more than 100 full-time employees, has gross revenues that do not exceed \$12 million.

For a **construction Contractor**, the term "Small Business Enterprise" shall mean a business certified by the State of New Jersey to qualify as a business which has its principal place of business in the State, is independently owned and operated, has no more than 100 full-time employees, has gross revenues that do not exceed either \$1 million or the applicable annual revenue standards set forth in 13 CFR 121.201, whichever is higher.

SPECIFICATIONS - The term "Specifications" means the terms, provisions, and requirements, bound together herein and designated the "Project Manual" and all revisions made to the Specifications in Addenda, or by Modification Order, signed by the Engineer and accepted by the Owner.

Unless a particular issue is designated, all references to the above specifications, standards, or methods shall be understood to refer to the issue in effect (including all amendments) on the date of the NOTICE TO BIDDERS.

STRAIGHTEDGE - An accurate, 10 foot square-edged straightedge used in testing variations in the surface to verify specified tolerances.

SUBCONTRACTOR - An individual, firm, partnership, corporation, or any acceptable combination thereof, to which the Contractor subcontracts part of the Work pursuant to the GENERAL CONDITIONS article entitled SUBCONTRACTING.

SUBGRADE - The surface of the roadbed upon which the first layer of the pavement structure and/or shoulder section is constructed.

SUBSTANTIAL COMPLETION - "Substantial Completion" shall be that degree of completion of the project or a designated portion of the project, sufficient to provide the Owner, at his discretion, the full-time use of the project or designated portion of the project of the purposes for which it was intended and if it is safe and convenient for use by the public.

Substantial Completion of an operating facility or system shall be that degree of completion that will provide a minimum of seven (7) continuous calendar days of successful operation during which all performance and acceptance testing has been successfully demonstrated to the Engineer. All equipment contained in the work, plus all other components necessary to enable the Owner to operate the facility in the manner that was intended, shall be complete on the Substantial completion date at the end of the seven (7) calendar days. Substantial Completion of all or any designated part of the work is not to be construed as the Contract completion. Additional provisions regarding Substantial Completion are set forth in Article "SUBSTANTIAL COMPLETION DATE" and "OWNER'S USE OF PORTIONS OF THE WORK" of these GENERAL CONDITIONS.

SUPERINTENDENT - The Contractor's authorized representative responsible for and in charge of the Work. The Superintendence shall be authorized to receive all communications from the Owner per Article "SUPERINTENDENCE."

SURETY - The corporate body bound with and for the Contractor for the full and complete performance of the Contract and for the payment of all debts and obligations pertaining to the Work.

TIME OF COMPLETION - "Time of Completion" is the duration allotted or completion date in the Contract for the Contractor to complete all or any portion of the Project called for under the Contract in all parts and requirements within the time or times for completion of the Contract set forth in the Information to Bidders.

UNBALANCED BID - The term "Unbalanced Bid" means a materially unbalanced bid where there is a reasonable doubt that award to the Bidder submitting a mathematically unbalanced bid, which is structured on the basis of nominal prices for some work and inflated prices for other work, will result in the lowest ultimate cost to the Owner.

UNBALANCED BID, MATHEMATICALLY - A bid containing lump sum or unit bid items that do not reflect reasonable actual cost plus a reasonable proportionate share of the Bidder's anticipated profit, overhead costs, and other indirect costs. Some examples of a mathematically unbalanced bid are 'front-end loading' and 'covering' (moving money from one item to another).

UTILITY - A publicly, privately, or cooperatively owned agency or agencies operated by one (1) or more persons or corporations for public service. For purposes of the Contract, railroads shall be considered utilities.

WORK - The word "Work" within these Contract Documents shall include all material, labor, utility services, tools, supplies, expendable equipment, and all appliances, machinery, transportation, and appurtenances necessary to perform and complete the Contract; and such additional items not

specifically indicated or described that can be reasonably inferred as belonging to the item described or indicated and as required by the good practice to provide a complete and satisfactory system or structure described in the Contract Documents and the carrying out of all duties and obligations imposed by the Contract Documents on the Contractor. As used herein, "provide" shall be understood to mean "furnish and install, complete in place."

WORKING DAY - Any calendar day, exclusive of:

1. Saturdays, Sundays, and holidays;
2. days on which the Contractor is specifically required by the Contract Documents to suspend construction operations; and
3. days on which the Contractor is prevented by inclement weather or conditions resulting immediately therefrom adverse to the current controlling operation or operations, as determined by the Engineer, from proceeding with regular work for at least 6 hours toward completion of the contract.

Unless work is suspended for causes beyond the Contractor's control, Saturdays, Sundays and holidays on which the Contractor's forces engage in regular work, requiring the presence of an inspector will be considered as working days.

4. RESERVED

5. RESERVED

BIDDING REQUIREMENTS AND CONDITIONS

6. INQUIRIES REGARDING THE PROJECT

Inquiries prior to the receipt of bids regarding any discrepancy, error, or omission, or concerning the intent or meaning of the Plans, Specifications, or other Contract Documents shall be directed to the Owner as provided in the Information to Bidders section. Bidders shall rely only upon written responses to their inquiries. Oral responses will be of no effect.

7. PREQUALIFICATION OF PROSPECTIVE BIDDERS

For Bridge and Highway Projects - proposals will be received only from Bidders who, at the time of Bid, provide with the Proposal and have, as required by statute, submitted under oath, statements relating to their financial ability, adequacy of plant and equipment, organization and prior experience, and other matters, on forms furnished by the Owner; who have been prequalified in the areas so designated by the SJPC in accordance with NJDOT Regulations Covering the Classification of Prospective Bidders issued in accordance with NJSA 27:7-35.1 *et seq.*

All Other Projects - The prime Contractor shall be prequalified by the New Jersey Department of Treasury, Division of Property Management and Construction (DPMC) in the areas so designated by the SJPC, which may include: Construction Manager as Contractor, Design Build, or General Construction

As set forth in the Bid Specifications, the Owner may also require DPMC classification or DOT Pre-qualification for Subcontractors in the following areas: Plumbing, HVAC, Electrical, and Concrete Repairs. Subcontractor DPMC OR DOT classification requirements shall be identified in the Listing of Subcontractors Declaration. General Contractors shall note on said list whether it will be performing the work in any such area that requires Subcontractor DPMC classification or DOT Pre-qualification and whether it is classified to perform such work.

SJPC reserves the right to require Bidders and/or Subcontractors to provide proof of both DOT prequalification and DPMC classification documentations in given disciplines as determined by the scope of the particular project.

8. DISQUALIFICATION OF PREQUALIFIED PROSPECTIVE BIDDERS

The Owner reserves the right to disqualify or refuse to receive a Proposal Form from a prospective Bidder even though prequalified as required by the Article titled "PREQUALIFICATION OF PROSPECTIVE BIDDERS," or reject a Proposal after having received same for any of the following reasons:

1. Lack of competency or lack of adequate machinery, plant, or other equipment.
2. Uncompleted work which in the judgment of the Owner, might hinder or prevent the prompt completion of additional work, if awarded.
3. Failure to pay, or satisfactorily settle, all bills due for labor, equipment, or material on previous Contracts.
4. Failure to comply with any prequalification regulations of the Owner.
5. Default under any previous contract.
6. Unsatisfactory performance on previous or current contracts.
7. Questionable moral integrity as determined by the Attorney General of New Jersey.
8. Failure to reimburse the Owner for monies owed on any previously awarded contracts including those where the prospective Bidder is a party to a joint venture and the joint venture has failed to reimburse the Owner for monies owed.
9. Documented failure to comply with the conditions of permits.

9. CONTENTS OF THE PROPOSAL

Upon request, the Owner will furnish prospective Bidders with a Proposal Form. The Proposal Form states the location and description of the Project, shows the approximate estimate of the various quantities and kinds of Work to be performed, and includes a schedule of Pay Items for which bid prices are invited. The Proposal Form and accompanying Specifications state the number of days or date in which the Project must be completed, the amount of the Bid Security, and the date, time and place of the opening of Proposals.

All papers bound with or attached to the Proposal Form are considered a part thereof and must not be altered and must be submitted with the Proposal. These papers must be submitted with the Proposal Form for official bid. Other Contract Documents are considered a part of the Proposal whether attached or not.

Prospective Bidders are required to pay the Owner the sum stated in the Specifications for each copy of the Proposal Form, Specifications, and each set of Plans. Informational copies of the Proposal Form are available by the Owner for review upon written request to the South Jersey Port Corporation, Purchasing Department, Two Aquarium Drive, Camden, New Jersey 08103.

10. INTERPRETATION OF QUANTITIES IN BID FORM

The quantities appearing in the bid form are approximate only and are prepared for the comparison of bids. Payment will be made only for the actual quantities of Work completed in accordance with the Contract. Such payment will be made at the original unit prices for the quantities of Work accepted by the Engineer. The form quantities of Work may be increased or decreased, or Pay Items may be eliminated in their entirety as hereinafter provided.

11. "IF AND WHERE DIRECTED" ITEMS

The Proposal Form may request bids on one (1) or more Pay Items to be incorporated into the Project "if and where directed" by the Engineer. Such items may not be located on the Plans. The estimated quantities set out in the Proposal Form for such items are presented solely for the purpose of obtaining a representative bid price, but are not intended to indicate the Owner's anticipation as to the quantities of such items which are to be actually incorporated into the Project. Depending on field conditions, such "if and where directed" items may or may not be incorporated into the Project and if incorporated, may be many times the estimated quantity or only a fraction thereof.

Incorporation of such items shall only be made on written directions of the Engineer. In the absence of written directions, no such items shall be incorporated into the Project and if incorporated will not be paid for. The Engineer may order incorporation of such items at any location within the Project and at any time during the Contract Time. Claims for additional compensation shall not be made because of any increase, decrease, or elimination of such items, nor because of an increase or decrease in the amount of Work due to the field conditions encountered in incorporating such items into the Project.

12. EXAMINATION OF CONTRACT DOCUMENTS AND SITE OF PROJECT

The Bidder shall examine carefully the site of the proposed Project and the Contract Documents before submitting a Proposal. The submission of a bid is conclusive evidence that the Bidder has made such examination and is fully aware of the conditions to be encountered in performing the Work and is fully aware of the requirements of the Contract Documents and has considered the following:

- A. Investigation of Subsurface and Surface Conditions - Where the Owner has made investigations of subsurface conditions in areas where Work is to be performed under the Contract, or in other areas, some of which may constitute possible local material sources, such investigations are made only for the purpose of study, estimating, and design. Where such investigations have been made, Bidders may, upon written request, inspect the records of the Owner as to such investigations subject to and upon the conditions set forth herein. Such inspection of records may be made at the South Jersey Port Corporation, Two Aquarium Drive, Camden, NJ 08103, or at such other locations as directed in response to the written request. In the event the Bidder's site examination reveals that the site conditions are inconsistent with the Contract Documents, the Bidder shall immediately notify the Owner.

Boring logs, if borings are taken, are part of the subsurface information made available. Such borings, which are taken solely for design purposes, were obtained with reasonable care and recorded in good faith. The soil and rock descriptions shown are determined by a visual inspection of samples from the various explorations unless otherwise noted. These samples are made available for nondestructive examination. The observed water levels and other water conditions indicated on the boring logs are as recorded at the time of the exploration. These levels and other conditions may vary considerably, with time, according to the prevailing climate, rainfall, and other factors. Boring logs may be inspected at the South Jersey Port Corporation, Two Aquarium Drive, Camden, NJ 08103, or at such other locations as directed in response to the written request.

The records of the Owner's subsurface investigation are not a part of the Contract and are made available for inspection solely for the convenience of the Bidder or Contractor. This investigation, while considered by the Owner to be sufficient for design purposes in both

scope and content, is not necessarily sufficient for construction purposes and is not keyed to the needs of the Bidder and Contractor.

It is expressly understood and agreed that the Owner assumes no responsibility whatsoever in respect to the sufficiency or accuracy of the subsurface investigations, the records thereof, or of the interpretations set forth therein or made by the Owner in its use thereof other than as used to establish a design for the Project's in-situ site conditions. There is no warranty or guarantee, either expressed or implied, that the conditions indicated by such investigations or records thereof are representative of those existing throughout such areas, or any part thereof, or that unlooked-for developments may not occur, or that materials other than, or in proportions different from those indicated, may not be encountered.

The availability or use of information described in this Article is not to be construed in any way as a waiver of the above provisions, and a Bidder is cautioned to make such independent investigation and examination as necessary to satisfy the Bidder as to conditions to be encountered in the performance of the Work and, with respect to possible local material sources, the quality and quantity of material available and the type and extent of processing that may be required in order to produce material conforming to the requirements of the Contract Documents.

Information derived from such inspection of records of investigations or compilation thereof made by the Owner, the Consultant, or assistants, does not relieve the Bidder or Contractor from any risk or from properly fulfilling the terms of the Contract.

Moreover, New Jersey is a small, heavily populated State whose physical geography has received thorough examination. The Bidder is charged with knowledge of the State's physical geography from publications prepared under the auspices of the Federal and State governments, educational institutions, and others. Therefore, the Bidder, in performing his site investigation, should be fully aware of the following publications and such others as may be listed in the Specifications:

1. State of New Jersey Department of Transportation Bulletin 50, Geologic Series, "The Geology of New Jersey" by H. Kummel, out of print, available generally as library reference material.
2. Geologic Maps of New Jersey, available through New Jersey Department of Environmental Protection (NJDEP).
3. Engineering Soils Survey of New Jersey, available through the Bureau of Research, College of Engineering, Rutgers University, New Brunswick, New Jersey 08903.
4. Soil Surveys of Individual Counties prepared by the US Department of Agriculture, Soil Conservation Service, in cooperation with the New Jersey Agricultural Experiment Station and Cook College, Rutgers University, available through local Soil Conservation District Offices.

The Bidder should also conduct such borings, soils tests, and other subsurface investigations and obtain such expert advice on site conditions, both surface and subsurface, as is required for bidding and for the construction of the Project.

- B. When contour maps have been used in the design of the Project and have not been incorporated in the Plans, the Bidders may inspect such maps upon written request, and if available, they may obtain copies for their use.

- C. Right-of-Way Availability - The Bidder shall consider the effect on his work schedule of any delays in right-of-way availability. The submission of a bid shall be considered conclusive evidence that the Bidder has considered such delays and made allowance for them in the progress schedule.
- D. Utilities - The Bidder shall consider the effect on his work schedule of GENERAL CONDITIONS Articles "COOPERATION WITH UTILITIES" and "COOPERATION BETWEEN CONTRACTORS." The Bidder shall make a diligent investigation of all utilities on the job site, including any necessary de-energization of power lines, and contact all utilities inquiring as to their planned operations and existing and proposed facilities prior to bidding.
- E. Other Contractors - The Bidder shall examine the Project site and adjacent areas so as to be fully aware of other Contractors working on or adjacent to the site. The Bidder shall become fully aware of the operations of such Contractors before bidding and how their operations affect his progress. The Bidder should also consider, and allow for in bidding, the right of the Owner at any time to contract for and perform other or additional work on or near the Project, and the conditions and terms of the Contract relative thereto as set forth in GENERAL CONDITIONS Article "COOPERATION BETWEEN CONTRACTORS."
- F. Mass Diagram and Cross-Sections - The swell or shrinkage of excavated material and direction and quantities of haul or overhaul as and if shown on said mass diagram are for the purpose of design only, and in like manner as provided in Subheading A above, concerning furnishing information resulting from subsurface investigations, the Owner assumes no responsibility whatever in the interpretation or exactness of any of the information shown on said mass diagram, and does not, either express or imply, make any guarantee of the same. Similarly, the cross-sections are not intended to be relied upon to accurately indicate the location or quantities of rock and soil. The Bidder should independently make an investigation as to the location, quality, and quantity of rock and soil.
- G. Existing Structures - A list of known existing structures within the Project will be listed in the Contract or on the Plans. If plans for such structures are available, the Bidder may, upon written request to the Owner, review the plans at the South Jersey Port Corporation, Two Aquarium Drive, Camden, NJ 08103, or at such other locations as directed in response to the written request. The Owner assumes no responsibility for the correctness of the Plans. Any information obtained from the existing Plans shall be verified by the Bidder prior to use of such information for bidding for the construction of the Project. In the event the Bidder's site examination reveals that the site conditions are inconsistent with the Contract Documents, the Bidder shall immediately notify the Owner.

13. PREPARATION OF PROPOSAL

The Bidder shall submit a Proposal on the forms furnished by the Owner. The Bidder shall specify a price in figures for each Pay Item. For lump sum items, the price should appear solely in the box provided for the lump sum item under the column designated as "Item Total." For unit price items the per unit price shall appear under the column designated "Unit Price" in the appropriate box, and the product of the respective unit price times the approximate quantity for that item shall appear under the column designated "Item Total." The "Total Amount Bid" is the sum of all figures shown in the column designated "Item Total" and shall appear at the location provided therefor. When the Bidder intends to bid zero (\$0.00) for a Pay Item, a "0" should appear in the "Unit Price" and "Item Total" columns for unit price items or in the "Item Total" column for lump sum items.

When the Proposal contains alternate items, the Bidder shall only provide the unit price and amount for the lowest priced alternate item. When alternate items in the proposal have a lump sum pay quantity, the Bidder shall only provide the amount for the lowest priced alternate item. The alternate item for which a price has been provided shall be constructed. When the proposal contains alternate groups of items, the Bidder shall only provide the unit price and amount for each item within the lowest priced alternate group. The alternate group of items for which a price has been provided shall be constructed.

All figures entered in the "Unit Price" and "Item Total" columns, and the figure entered for the "Total Amount Bid" shall be in ink or typed. Bids will be accepted only if submitted on the Proposal Form supplied by the Owner. In all instances, the Proposal Form shall govern. Bid prices presented on any other form by the Bidder, if different from those submitted on the Proposal Form, shall not govern.

The Proposal Form must be signed in ink by the Bidder. If the Bidder is an individual, the Bidder's name must be shown; by a partnership, the name of each partnership member must be shown; as a joint venture, the name of each member or officer of the firms represented by the joint venture must be shown; by a corporation, the name of the corporation and the authorized officers name must be shown.

14. BALANCED BIDS

Each Pay Item should reflect the actual cost which the Bidder anticipates incurring for the performance of that particular item, together with a proportional share of the Bidder's anticipated profit, overhead, and costs to perform work for which no separate Pay Item is provided. In no event will the Owner consider any claim for additional compensation arising from the bid on an item, or group of items, inaccurately reflecting a disproportionate share of the Bidder's anticipated profit, overhead, and other costs.

15. DELIVERY OF PROPOSALS

Each Proposal should be submitted in a sealed envelope or, if provided, in the special envelope furnished by the Owner. The envelope shall be filled in correctly to clearly indicate it as a Bid Proposal and not to open until date and time of bid opening. When an envelope other than the special one furnished by the Owner is used, it shall be of the same general size and shape and be similarly marked to clearly indicate its contents. The Proposal shall be mailed, or hand carried to the Owner at the address and in care of the official in whose office the bids are to be received. Proposals must be received prior to or at the time and at the place specified in the Advertisement. Proposals will not be accepted after the receipt of bids has been declared closed by the Presiding Officer. Enclosed in the sealed envelope with the Proposal shall be submitted the following documents:

- A. The BID SECURITY as described in GENERAL CONDITIONS Article "BID SECURITY."
- B. The Proposal Section is to be completed and submitted with the Proposal. The Proposal Section contains the following:
 - 1. Bid Document Submission Checklist
 - 2. Bid Guarantee
 - 3. Certificate from a surety company
 - 4. Listing of Subcontractors
 - 5. Bidder's acknowledgement of receipt of any notice(s) or revision(s) or addenda to an advertisement, specifications or bid document(s)
 - 6. Bid Form

7. Federal Affirmative Action Form
8. Ability Questionnaire
9. Debarred List Affidavit
10. Submission of a Non-Collusion Affidavit
11. Prevailing Wage Act Compliance Declaration
12. Business Registration Certification
13. Any other additional submissions identified on the Bid Document Submission Checklist
14. General Contractor DPMC Classification or NJDOT Prequalification form(s) as required.

16. BID SECURITY

The Proposal, when submitted, shall be accompanied by a Bid Security satisfactory to the Owner, on the form furnished by the Owner, for a sum of not less than ten percent (10%) of the TOTAL BID PRICE but not to exceed \$20,000.00. The Bid Security shall be properly filled out, signed, and witnessed, and shall be furnished only by such surety company or companies authorized to do business in the State of New Jersey as are listed in the current US Treasury Department Circular 570 as of the date for receipt of bids for the particular Project. The Proposal Bond shall be accompanied by a copy of the power of attorney executed by the Surety Company or companies. The power of attorney shall set forth the Owner of the attorney-in-fact who has signed the bond on behalf of the surety company to bind the company and shall further certify that such power is in full force and effect as of the date of the bond.

17. WITHDRAWAL OF PROPOSALS

A Bidder may withdraw a Proposal after it has been submitted to the Owner, provided the request for such withdrawal is received by the Owner, in writing or by telegram, before the time set for opening Proposals. Proposals shall not be withdrawn after the time designated for the public opening of such Proposal, except that when Proposals for more than one (1) project are to be opened at the same time, a Bidder, at his option, may submit a written request to withdraw his Proposal for the second or succeeding project. The Bidder shall notify the Owner, in writing, of his intent to exercise this option before the time set for opening of Proposals. In such event, a short interval of time will be allowed between project Proposal openings to allow the Bidder time to submit a written request for withdrawal of bid. Upon presentation of the written request at the proper time, a Bidder's Proposal will be returned unopened.

18. COMBINATION OR CONDITIONAL PROPOSALS

If the Owner so elects, Proposal Forms may be issued for projects in combination and/or separately, so that bids may be submitted either on the combination or on separate units of the combination. The Owner reserves the right to make awards on combination bids or separate bids to the best advantage of the Owner. Combination bids other than those specifically provided for in the Proposal Forms will not be considered. Separate Contracts will be awarded for each individual Project included in the combination. Conditional Proposals will be considered only when provided for in the Specifications.

19. ACKNOWLEDGEMENT OF REVISIONS

When Addenda and other forms of notice giving revisions and interpretations of the Contract Documents are mailed or otherwise transmitted to prospective Bidders, acknowledgement thereof must be made by the Bidder. The acknowledgment shall be sent or hand delivered to the office and/or individual noted on the form and must be received before the Proposal of the Bidder concerned is

opened. If the acknowledgment has not been received prior to the opening of bids, the bid envelope will be returned to the Bidder unopened.

20. PUBLIC OPENING OF PROPOSALS

Proposals will be opened and read publicly at the time and place indicated in the *Notice to Bidders* or such other time and place as may be established by Addendum. Bidders, their authorized agents, and other interested parties are invited to be present.

21. IRREGULAR PROPOSALS

Proposals will be considered irregular and may be rejected for the following reasons:

- A. If the Proposal is on a form other than that furnished by the Owner or if the form is altered or any part thereof is detached or incomplete.
- B. If the Proposal is not properly signed.
- C. If the bid is not typed or not in ink
- D. If there are unauthorized additions, conditional or alternate bids, or irregularities of any kind which may tend to make the Proposal incomplete, indefinite, or ambiguous as to its meaning.
- E. If the Bidder adds any provisions reserving the right to accept or reject an award, or to enter into a contract pursuant to an award. The prohibition does not exclude a reservation limiting the maximum gross amount of awards acceptable to any one (1) Bidder at any one (1) bid letting. However, the Owner will make the selection of which Contract or Contracts are to be awarded to such Bidder within the maximum gross amount reserved.
- F. If the Bidder makes an alteration of the "Unit Prices" or "Amounts" that have been included by the Owner, unless otherwise directed by Addendum received prior to receipt of bids.
- G. Subject to GENERAL CONDITIONS Article "CONSIDERATION OF PROPOSAL," if the Proposal does not contain a unit price for each Pay Item listed or a Total Contract Price. In the case of alternate items or alternate groups of items, the Bidder shall provide prices as stated in GENERAL CONDITIONS Article "PREPARATION OF PROPOSAL" and the Proposal.
- H. If the Proposal is not accompanied by the Proposal Bond as specified in GENERAL CONDITIONS Article "PROPOSAL BOND."
- I. If acknowledgment of letters and other notices to prospective Bidders, giving revisions of or amendments to the Contract Documents, have not been received as prescribed in GENERAL CONDITIONS Article "ACKNOWLEDGEMENT OF REVISIONS."
- J. If the Executive Director deems it advisable to do so in the interest of the Owner.

22. DISQUALIFICATION OF BIDDERS

Any of the following reasons may be considered as being sufficient for the disqualification of a Bidder and the rejection of his Proposal:

- A. More than one (1) Proposal for the same work from an individual, firm, partnership, corporation, or combination thereof, under the same or different names. Reasonable grounds for believing that any individual, firm, partnership, corporation, or combination thereof, is interested in more than one (1) Proposal for the work contemplated may cause the rejection of all Proposals in which such individual, firm, partnership, corporation, or combination thereof, is interested.

- B. Evidence of collusion among Bidders. Participants in such collusion will not be permitted to submit bids for future work of the Owner until reinstatement as a qualified Bidder by the Executive Director.
- C. If any Pay Item bid price is obviously unbalanced. However, non-rejection of a bid on this basis shall not be deemed to be a determination by the Owner that the bid is balanced.
- D. Uncompleted work which, in the judgment of the Owner, might hinder or prevent the prompt completion of additional work, if awarded.
- E. Failure to satisfy the requirements of the Minority Utilization attachments included in the Specifications.

23. RESERVED

24. RESERVED

AWARD AND EXECUTION OF CONTRACT

25. CONSIDERATION OF PROPOSALS / BID DISCREPANCIES

Where applicable, Bidders shall state on such form a unit price (**written in words and numbers**) for each item bid, and such unit prices shall be extended, and extensions added to produce a total bid price. For the purpose of the comparison of bids received, they are re-tabulated by the Owner. The total re-tabulated by the Owner will prevail.

When evaluating bids the following shall apply:

- Discrepancies between words and figures will be resolved in favor of words.
- Discrepancies between unit prices and totals of unit prices will be resolved in favor of the unit prices.
- Discrepancies in the multiplication of units of work and unit prices will be resolved in the favor of the unit prices.
- Discrepancies between the indicated total of multiplied unit prices and units of work and the actual total will be resolved in favor of the actual total.
- Discrepancies between the indicated sum of any column of figures and the correct sum thereof will be resolved in favor of the corrected sum of the column of figures.
- Discrepancy where a unit price is bid for a Pay Item, but no extension is provided; the Owner will provide the extension based on the unit price bid and the estimated quantity for that Pay Item.
- Discrepancy where an extension is provided by the Bidder in the "Item Total" column, but no unit price appears in the "Unit Price" column of the Proposal Form, the Owner will provide the unit price by dividing the "Item Total" figure provided by the Bidder by the estimated quantity.

In the event a corporation not incorporated in the State of New Jersey is the lowest Bidder, it shall be authorized to do business in New Jersey pursuant to NJSA 14A:15 *et seq.*

The Owner may reject any and all Proposals when the Owner determines that it is in the public interest to do so. The Owner reserves the right to waive technicalities or to advertise for new Proposals.

26. AWARD OF CONTRACT

The Award will be made to the lowest responsible Bidder whose Proposal conforms in all respects to the requirements set forth in the Contract Documents. The Owner will award the Contract or

reject all bids 90 calendar days after the bids are received. The Owner may make a Conditional Award pending the approval of the Federal Government, another State governmental body, or private party. Should the Contract not be awarded or conditionally awarded within 90 calendar days, all Bidders shall have the right to withdraw their bids. However, the Owner and the lowest responsible Bidder and/or the second lowest responsible Bidder can agree to extend the time within which the Owner may make an award or conditional award by mutual consent.

For AIP Contracts, unless otherwise specified in this Section, no award shall be made until the FAA has concurred in the Owner's recommendation to make such award and has approved the Owner's proposed contract to the extent that such concurrence and approval are required by 49 CFR Part 18.

At the time of Award or Conditional Award to a Bidder not a resident of the State of New Jersey, such Bidder shall appoint, on the form furnished by the Owner, a proper agent in the State of New Jersey on whom service can be made in event of litigation of any type arising under the Contract or as a result of performance of the Contract. Said agency shall remain in effect during the performance of the Contract and for six (6) years following Acceptance.

The Award or Conditional Award is not binding upon the Owner until the Contract has been executed by the Owner's Executive Director, nor shall any work be performed on account of the proposed Contract until the prospective Contractor has been notified that the Contract has been executed by the Executive Director, and then only as provided in GENERAL CONDITIONS Article "COMMENCEMENT OF WORK."

27. CANCELLATION OF AWARD

The Owner reserves the right to cancel an Award or Conditional Award at any time before the execution of said Contract by all parties without any liability against the Owner.

28. RETURN OF BID SECURITY

All Bid Securities except those of the three (3) lowest Bidders will be returned to Bidders as soon as possible after the award of a contract. The Bid Security of the lowest and next lowest Bidders will be returned when the Contract and Performance Bond and Payment Bond have been executed and delivered in accordance with the provisions of GENERAL CONDITIONS Article "EXECUTION AND APPROVAL OF CONTRACT," or, if not executed, when other disposition of the matter has been made by the Owner. However, when the Award or Conditional Award has been annulled due to failure of the Bidder to whom award was made to execute and deliver the Contract and Performance Bond and Payment Bond, the Bid Security of such Bidder shall become operative as provided in GENERAL CONDITIONS Article "FAILURE TO EXECUTE CONTRACT."

29. EXECUTION AND APPROVAL OF CONTRACT

The Contract shall be signed by the successful Bidder and returned, together with the Performance Bond and Payment Bond, within ten calendar days of the date of receipt of the contract by the successful Bidder from the Owner. If the Contract is not executed by the Owner within 120 calendar days following receipt from the Bidder of the signed Contract and Performance Bond and Payment Bond, the Bidder shall have the right to withdraw his bid without penalty. The Contract is not effective until it has been fully executed.

30. PERFORMANCE BOND AND PAYMENT BOND

Within ten calendar days of the date of Award or Conditional Award, the Bidder to whom the Contract has been awarded shall complete and deliver a Performance Bond and a Payment Bond in accordance with the requirements of the Owner. Each bond shall be the sum of not less than the Total Contract Price and shall be maintained by the Contractor until Acceptance. In the event of the insolvency of the surety or if the Performance Bond and Payment Bond have not been properly authorized or issued by the Surety company, the Contractor shall furnish and maintain, as above provided, other surety satisfactory to the Owner.

All alterations, extensions of Contract Time, extra and additional work, and other changes authorized by the Contract Documents may be made without securing the consent of the surety or sureties of the bonds.

The surety corporation bonds shall be furnished by only those sureties listed in the US Treasury Department Circular 570 and authorized to do business in the State of New Jersey. The bonds shall be accompanied by a certification as to authorization of the attorney-in-fact to commit the surety company and a true and correct statement of the financial condition of said surety company.

31. FAILURE TO EXECUTE CONTRACT

Failure on the part of the Bidder to whom the Contract has been awarded to execute and deliver the Contract as provided in GENERAL CONDITIONS Article "EXECUTION AND APPROVAL OF CONTRACT", and the bonds as provided in Article "PERFORMANCE BOND AND PAYMENT BOND", in the manner and within the time provided, is just cause for annulment of the Award or Conditional Award and for the exclusion of the Bidder from bidding on subsequent projects for such period as the Owner may deem appropriate. If the Award is annulled for the above reasons, the Proposal Bond, as described in GENERAL CONDITIONS Article "PROPOSAL BOND," shall become forfeited and the Owner may proceed to recover under the terms and provisions of the Proposal Bond. Award may then be made to the next lowest responsible Bidder, or the Work may be re-advertised and constructed under contract, or otherwise, as the Owner may decide. The successful Bidder may file with the Owner a written notice, signed by the Bidder or the Bidder's authorized representative, specifying that the Bidder refuses to execute the Contract. The filing of such notice has the same force and effect as the failure of the Bidder to execute the Contract and furnish a Performance Bond and Payment Bond within the time herein before prescribed.

32. RESERVED**33. RESERVED**

SCOPE OF WORK

34. INTENT

The Contract Documents are complementary, and what is called for by one part shall be as binding as if called for by all. The intent of the Contract Documents is to describe a functionally complete and aesthetically acceptable Project to be constructed and completed by the Contractor in every detail in accordance with the Contract Documents. Any Work that may be reasonably inferred from the Contract Documents as being required to produce the intended result shall be supplied whether or not specifically called for. Where the Contract Documents describe portions of the Work in general terms, but not in complete detail, it is understood that only the best construction practice is to prevail and only materials and workmanship of the first quality are to be used. The intent of the Documents is to include all work (except specific items to be furnished by the Owner) necessary for completion of the Contract. Materials or work described in words that indicate the proper execution and a well-known technical or trade designation shall be held to refer to such recognized standards. Only where the Contract Documents specifically describe a portion of the Project as being performed by others is the Work deemed not to constitute construction of the entire Project. It is understood and agreed that the written terms and provisions of the Contract Documents represent the entire and integrated agreement between the parties hereto and supersede all prior negotiations, representations, or agreements, either written or oral.

35. CHANGES

The Owner reserves the right to make such alterations, deviations, additions to, or omissions from the Contract Documents, including the right to increase or decrease the quantity of any Pay Item or portion of the Work or to omit any Pay Item or portion of the Work, and to require Extra Work as needed for the satisfactory completion of the Project. Such increases or decreases, alterations, and omissions do not invalidate the Contract nor release the Surety, and the Contractor agrees to accept the Work as altered, the same as if it had been a part of the original Contract.

Changes which solely involve the increase or decrease in the quantity of Pay Items (not involving unit price adjustments pursuant to GENERAL CONDITIONS Articles "INCREASED OR DECREASED QUANTITIES" and "PAYMENT FOR MODIFICATIONS," the elimination of Pay Items, the adjustment of the estimated quantities in the Proposal as the result of as-built calculations, or minor changes in the Work as provided in GENERAL CONDITIONS Article "MINOR CHANGES IN THE WORK," may be effected by Field Order or Change Order, as determined by the Engineer. All other changes will be included in a Change Order which specifies, in addition to the Work to be done, an adjustment of Contract Time, if any, and the basis of compensation for such Work. A Change Order submitted by the Engineer does not become effective until appropriate signatures have been affixed. Once a certain monetary threshold has been exceeded, Change Orders require Board of Commissioners approval. Once the Board of Commissioners has approved the proposed Change Order, the Governor has a subsequent 30 day veto period.

Upon receipt of a Field Order or Change Order, the Contractor shall proceed with the ordered Work. Where the changes involved require a Change Order, and a Change Order has not yet been issued, the Engineer may direct, by Field Order, that the Contractor proceed with the desired Work, and the Contractor shall comply. In such cases, the Engineer will, as soon as practicable, issue a Change Order for such Work. When the compensation for an item of Work is subject to adjustment under the provisions of GENERAL CONDITIONS Articles "PROCEDURES AND PROTEST," "INCREASED OR DECREASED QUANTITIES," "ELIMINATED ITEMS," "CHANGES IN CHARACTER OF WORK," "EXTRA WORK," "NOTIFICATION OF CHANGES" or "PAYMENT FOR MODIFICATIONS," the Contractor shall, upon request, furnish the Engineer with adequate detailed cost data for such item of Work. If the Contractor requests an adjustment in compensation for an item of Work as provided in GENERAL CONDITIONS Articles "INCREASED OR DECREASED

QUANTITIES” and “PAYMENT FOR MODIFICATIONS,” such cost data shall be submitted with the request.

In addition to Field Orders and Change Orders, the terms and conditions relating to changes may be negotiated with the Contractor. If the Contractor signifies acceptance of such terms and conditions by executing a Supplementary Agreement, and if such Supplementary Agreement is approved by the Owner, the Engineer will issue payment to the Contractor in accordance with the terms and conditions as to compensation and adjustments in the Contract Time therein set forth which shall constitute full compensation and mutually acceptable adjustment of Contract Time for all Work included therein or required thereby. The Contractor agrees that a proposed Supplementary Agreement which is not approved by the Owner and Governor, or which is rejected by the Contractor shall have no effect and that neither may attempt to use it in any litigation which may result from the Contract.

If the Contractor intends to assert a claim for an equitable adjustment under this Article, he must, within seven (7) days after receipt of the Owner’s alterations, deviations, additions to, omissions from the Contract Documents, or directed Extra Work and prior to performing the work, submit to the Owner a written statement setting forth the general nature and monetary extent of such claim.

No claim for additional compensation shall be made because of any such alteration, deviation, addition to, or omission from the Work required by the Contract, by reason of any variation between the approximate quantities in the Bid Form and the quantities of Work as done, by reason of Extra Work, by reason of elimination of Pay Items, or by reason of changes in the character of Work except as allowed in this Section. Attention is directed to GENERAL CONDITIONS Articles “BALANCED BIDS.”

No claim for additional compensation or extension of Contract Time within the scope of this Section will be allowed if asserted after Acceptance. No claim by the Contractor for an equitable adjustment hereunder shall be allowed if asserted after final payment under this Contract.

36. MINOR CHANGES IN THE WORK

The Resident Engineer has the Owner to order minor changes in the Work not involving an adjustment to the unit or lump sum prices, or an adjustment to Pay Items, or an extension of Contract Time, and not inconsistent with the intent of the Contract Documents. Such changes may be effected by Field Order and are binding on the Owner and the Contractor. Additional compensation or extension of Contract Time will not be allowed.

37. PROCEDURE AND PROTEST

A Field Order or Change Order may be issued at any time. Should the Contractor disagree with any terms or conditions set forth in a Field Order or a Change Order, the Contractor shall submit a written protest to the Engineer within seven (7) days after the receipt of such Field Order or Change Order or prior to performing the work. The protest shall state the points of disagreement, and, if possible, the specification references, quantities, and costs involved. The protest shall be a specific, detailed statement of the points of disagreement, and the Engineer reserves the right to reject general protests. Rejected general protests, which are not cured by the submission of a specific, detailed statement within five (5) days of such rejection will not be considered. If a written protest is not submitted, payment will be made as set forth in the Field Order or Change Order and such payment constitutes full compensation for all Work included therein or required thereby and also is conclusive as to any Contract Time adjustments provided for therein or in establishing that no Contract Time adjustment was warranted.

Protests related to Work ordered by Field Order, but as to which a Change Order is required, shall be made within seven (7) days after receipt of the Field Order or prior to performing the work. Subsequent issuance of the Change Order shall not be the basis for a protest except to the extent that the Change Order differs materially from the Field Order.

Where the protest concerning a Field Order or a Change Order relates to compensation, the compensation payable for all Work specified or required by said Field Order or Change Order to which such protest relates, if later deemed appropriate by the Engineer, will be determined as provided in GENERAL CONDITIONS Articles "PAYMENT FOR MODIFICATIONS," "INCREASED OR DECREASED QUANTITIES," "ELIMINATED ITEMS," "CHANGES IN CHARACTER OF WORK," and "EXTRA WORK." The Contractor shall keep full and complete records of the cost of such Work and shall permit the Engineer to have such access thereto consistent with GENERAL CONDITIONS Article "AUDIT: ACCESS TO RECORDS," as may be necessary to assist in the determination of the compensation payable for such Work.

Where the protest concerning a Change Order relates to the adjustment of Contract Time, the time to be allowed, if later deemed appropriate, will be determined as provided in GENERAL CONDITIONS Articles "TERMINATION FOR DEFAULT, DAMAGES FOR DELAY, TIME EXTENSIONS," "CLAIMS FOR ADDITIONAL TIME AND/OR COMPENSATION" and "EXTENSION OF TIME."

38. INCREASED OR DECREASED QUANTITIES

Increases or decreases in the quantity of a Pay Item will be determined by comparing the total actual quantity of such item of Work with the quantity contained in the Proposal. In making such a comparison, quantities which are the subject of Supplementary Agreements or Change Orders for Extra Work will not be considered.

Minor Pay Items are not eligible for any adjustment in unit price regardless of how much the total as-built quantity varies from the quantity contained in the Proposal unless eligible for adjustment pursuant to GENERAL CONDITIONS Article "CHANGES IN THE CHARACTER OF THE WORK".

If the total pay quantity of any Major Pay Item varies from the estimate contained in the Proposal by more than 25 percent, payment will be made in accordance with the following categories:

- A. Increases of More Than 25 Percent
 1. Lump-Sum Items - Should the total actual quantity of or actual component quantity for lump sum Items of any Major Pay Item exceed the estimate contained in the Proposal by more than 25 percent, the Work in excess of 125 percent of such estimate will be paid for by adjusting the unit price, as hereinafter provided. Alternatively, the Contractor and Engineer may request in writing to negotiate a Supplementary Agreement for such adjustment.
 2. Unit Price - Such adjustment of the unit price is to be the difference between the unit price and the actual unit cost, which will be determined as hereinafter provided. If the costs applicable to such item of Work include overhead, such overhead will be deemed to have been recovered by the Contractor by the payments made for the 125 percent of the Contract quantity for such item already paid, and in computing the actual unit cost, such overhead will be excluded. Subject to the above provisions, such actual unit costs will be determined in the same manner as if the Work were to be paid for on a Force Account basis as provided in GENERAL CONDITIONS Article "PAYMENT FOR MODIFICATION."

When the compensation payable for the number of units of an item of Work performed in excess of 125 percent of the Engineer's estimate is less than \$1,500 at the applicable unit price, the Engineer reserves the right to make no adjustment in said price if the Engineer so elects, except that an adjustment may be made if requested in writing by the Contractor.

B. Decreases of More than 25 Percent

1. Lump Sum - Should the total actual quantity or component quantity for lump sum Items of any Major Pay Item be less than 75 percent of the estimate contained in the Proposal Form, an adjustment in compensation pursuant to this Article will not be made unless the Contractor so requests in writing. If the Contractor so requests, the quantity of said item performed will be paid for by adjusting the unit price as hereinafter provided, or at the option of the Engineer, payment for the quantity of the Work of such item performed will be made on the basis of Force Account as provided in GENERAL CONDITIONS Article "PAYMENT FOR MODIFICATION," provided, however, that in no case shall the payment for such Work be less than that which would be made at the unit price bid. Alternately, the Contractor or Engineer may request in request to negotiate a Supplementary Agreement for such adjustment.
2. Unit Price - Such adjustment of the unit price is to be the difference between the unit price and the actual unit cost, which will be determined as hereinafter provided, of the total actual quantity of the item, including overhead. Such actual unit cost will be determined in the same manner as if the Work were to be paid for on a Force Account basis as provided in GENERAL CONDITIONS Article "PAYMENT FOR MODIFICATION."

The payment for the total actual quantity of such item of Work is not to exceed the payment which would be made for the performance of 75 percent of the estimate contained in the Proposal for such item at the original unit price bid or component cost for lump sum items.

39. ELIMINATED ITEMS

Should any Pay Item contained in the Proposal be found unnecessary for the proper completion of the Work, the Engineer may, upon written order to the Contractor, eliminate such item from the Contract. In such case compensation, if any is appropriate, will be made as provided in this Article.

If acceptable material is ordered by the Contractor for the eliminated item prior to the date of notification of such elimination and if orders for such material cannot be canceled, material will be paid for at the actual cost to the Contractor. In such case, the material paid for becomes the property of the Owner, and the actual cost of any further handling will be paid for by the Owner. If the material is returnable to the vendor, and if the Engineer so directs, the material shall be returned, and the Contractor will be paid for the actual cost or charges made by the vendor for returning the material. The actual costs of handling returned material will be paid for by the Owner.

The actual costs or charges will be computed in the same manner as if the Work were to be paid for as provided in GENERAL CONDITIONS Article "PAYMENT FOR MODIFICATIONS." However, no profit will be allowed.

40. DIFFERING SITE CONDITIONS

- A. The Contractor shall immediately, and before such conditions are disturbed, except in the event of an emergency, notify the Owner by written notice of:
1. Subsurface or latent physical conditions at the site differing materially from those indicated in this Contract; or
 2. Unknown physical conditions at the site, of an unusual nature, differing materially from those ordinarily encountered and generally recognized as inherent in the work of the character provided for this Contract.

The Engineer shall promptly investigate the conditions. If he finds that such conditions do materially differ and cause an increase or decrease in the Contractor's cost of, or the time required for, performance of any part of the work under this Contract, whether or not changed as a result of such conditions, an equitable adjustment shall be made and the Contract modified in writing accordingly.

- B. No claim of the Contractor under this Article shall be allowed unless the Contractor has given the notice required in Paragraph A of this Article, except that the Owner may extend the prescribed time.
- C. No claim of the Contractor shall be allowed if filed later than thirty (30) days after the differing site condition has been overcome unless such period is extended by the Owner.
- D. No claim by the Contractor for an equitable adjustment hereunder shall be allowed if asserted after final payment under this Contract.

41. CHANGES IN CHARACTER OF WORK

If the Engineer determines that an ordered change in the Work materially changes the character of the Work of a Pay Item, or a portion thereof, and if the change substantially increases or decreases the actual unit cost of such changed item as compared to the actual or estimated cost of performing the Work of said item in accordance with the Contract Documents originally applicable thereto, in the absence of a Supplementary Agreement or unprotested Change Order specifying the compensation payable, an adjustment in compensation will be made in accordance with the following:

- A. The basis of such adjustment in compensation will be the difference between the actual unit cost to perform the Work of said item or portion thereof involved in the change as originally planned and the actual unit cost of performing the Work of said item or portion thereof involved in the change, as changed. Actual unit costs will be determined in the same manner as if the Work were to be paid for as provided in GENERAL CONDITIONS Article "PAYMENT FOR MODIFICATIONS," or such adjustment is as agreed to in a Supplementary Agreement. Any such adjustment is to apply only to the portion of the Work of said item actually changed in character.
- B. At the option of the Engineer, the Work on said item or portion of item which is changed in character will be paid for as provided in GENERAL CONDITIONS Article "PAYMENT FOR MODIFICATIONS."
- C. If the compensation for an item of Work is adjusted under this Article, the costs recognized in determining such adjustment and quantity involved will be excluded from consideration in making an adjustment for such item of Work under the

provision in GENERAL CONDITIONS Article "INCREASED OR DECREASED QUANTITIES."

Failure of the Engineer to recognize a change in character of the Work at the time a Field Order or Change Order is issued does not relieve the Contractor of the duty and responsibility of filing a written protest within the five (5) day limit as provided in GENERAL CONDITIONS Article "NOTIFICATION OF CHANGES."

An adjustment in compensation will be made if there is an increase or decrease in excess of five percent (5%) in solid waste disposal costs incurred as a result of lawful increases or decreases in the rates, fees, or charges of the solid waste facility to be used or due to an order issued by the NJDEP in conjunction with the Bureau of Public Utilities directing the solid waste to be disposed at a solid waste facility other than the disposal facility previously used. Adjustments in compensation will be made in accordance with the provisions above. Adjustments in compensation will not be made if actual disposal costs have changed by less than five percent (5%) of the fee structure provided in accordance with the requirements of GENERAL CONDITIONS Article "PROSECUTION OF THE WORK."

42. EXTRA WORK

The Owner reserves the right to require Extra Work as needed for the satisfactory completion of the Project. Such Work will be designated as Extra Work when it is determined by the Engineer that such Work is not covered by any of the various items for which there is a bid price or combinations of such items. In the event portions of such Work are determined to be covered by some of the various items for which there is a bid price or combinations of such items, the remaining portion of such Work will be designated as Extra Work. Extra Work also includes Work specifically designated as Extra Work in the Contract Documents.

The Contractor shall do such Extra Work and furnish labor, material, and equipment therefor upon receipt of a Change Order, Field Order, or Supplementary Agreement. In the absence of such, the Contractor shall not perform, nor be entitled to payment for, such Extra Work.

Payment for Extra Work required pursuant to the provisions in this Article will be made as provided in GENERAL CONDITIONS Article "PAYMENT FOR MODIFICATIONS, or as agreed to in a Supplementary Agreement.

If the Contractor and the Engineer cannot agree on a Supplementary Agreement for Extra Work and the Engineer deems it inadvisable to have such Work completed on a Force Account basis as provided in GENERAL CONDITIONS Article "PAYMENT FOR MODIFICATIONS," the Owner may elect to have such Work completed by others, and the Contractor shall not interfere therewith nor have any claim for additional compensation as the result of such election.

43. NOTIFICATION OF CHANGES

The Contractor shall promptly report Owner conduct which the Contractor believes to constitute a change to the Contract. Except for changes identified as such pursuant to GENERAL CONDITIONS Articles "CHANGES" and "MINOR CHANGES IN THE WORK," the Contractor shall promptly notify the Engineer in writing within 14 calendar days from the date that the Contractor identifies any Owner conduct including actions, inactions, and written or oral communications, which the Contractor regards as a change to the Contract terms and conditions. In no event shall the Contractor begin Work nor incur any expenses with relation to the claimed change prior to giving notice. The notice shall state the following on the basis of the most accurate information available to the Contractor:

- A. The date, nature, and circumstances of the conduct regarded as a change.
- B. The name, function, and activity of each Owner individual and official or employee involved in or knowledgeable about such conduct.
- C. The identification of any documents and the substance of any oral communication involved in such conduct.
- D. In the instance of alleged acceleration of scheduled performance or delivery, the basis for the Contractor's claim of accelerations.
- E. In the instance of alleged Extra Work, the basis for the Contractor's claim that the Work is extra.
- F. The particular elements of Contract performance for which the Contractor may seek additional compensation under this Section including:
 - (1) What Pay Items have been or may be affected by the alleged change.
 - (2) What labor or materials or both have been or may be added, deleted, or wasted by the alleged change and equipment idled, added, or required for additional time.
 - (3) To the extent practicable, what delay and disruption in the manner and sequence of performance and effect on continued performance have been or may be caused by the alleged change.
 - (4) What adjustments to Contract price, delivery schedule, and other provisions affected by the alleged change are estimated.

Following submission of the notice, the Contractor shall diligently continue performance of the Contract to the maximum extent possible in accordance with the Contract Documents, unless such notice results in a direction by the Engineer, in which event the Contractor shall continue performance in compliance therewith, provided, however, that if the Contractor regards such direction itself as a change, notice shall be given as provided above. All directions, orders, and similar actions of the Engineer will be reduced to writing and copies thereof furnished to the Contractor. The Resident Engineer will promptly, and in any event within ten days after receipt of notice, respond thereto in writing. In such response, the Resident Engineer will do one of the following:

- A. Confirm that the conduct of which the Contractor gave notice constitutes a change, and when necessary direct the mode of further performance.
- B. Revise or rescind any communication regarded as a change.
- C. Deny that the conduct of which the Contractor gave notice constitutes a change, and when necessary direct the mode of further performance; or
- D. In the event the Contractor's notice information is inadequate to make a decision under Items A, B, or C of this paragraph, advise the Contractor as to what additional information is required, and establish the date by which it should be furnished and the date thereafter by which the Owner will respond.

If the Engineer confirms that Owner conduct effected a change as alleged by the Contractor, and such conduct causes an increase or decrease in the cost of, or the time required for performance of any part of the Work under the Contract, whether changed or not changed by such conduct, an adjustment in compensation will be made in accordance with the provisions of this Section, and the Contract will be modified in writing accordingly. In the case of drawings, designs, or specifications which are defective and for which the Owner is responsible, the adjustment will be made to include the cost and extension of Contract Time for delay reasonably incurred by the Contractor in attempting to comply with such defective drawings, designs, or specifications before the Contractor identified, or reasonably should have identified, such defect. When the cost of property made obsolete or excess as a result of a change confirmed by the Engineer pursuant to this Article is included in the adjustment in compensation, the Engineer has the right to prescribe the manner of disposition of such property. Adjustments will not be made which include increased costs or extensions of Contract Time for delay resulting from the Contractor's failure to provide adequate

notice or to continue performance as provided above. Any adjustments of Contract Time will be made pursuant to GENERAL CONDITIONS Articles "TERMINATION FOR DEFAULT, DAMAGES FOR DELAY, TIME EXTENSIONS," "CLAIMS FOR ADDITIONAL TIME AND/OR COMPENSATION" and "EXTENSION OF TIME."

The failure of the Contractor to give notice pursuant to the provisions of this Article shall constitute a waiver of any and all claims and damages which could have been avoided or mitigated had such timely notice been given. Moreover, no action or inaction of any person shall constitute a waiver of the Owner's absolute right to receive written notice of an alleged claim pursuant to this Article.

44. RIGHTS IN AND USE OF MATERIALS FOUND ON THE WORK

The Contractor, with the approval of the Engineer, may use on the Project such stone, gravel, sand, or other material determined suitable by the Engineer, as may be found in the excavation and will be paid both for the excavation of such materials at the corresponding unit price and for the Pay Item for which the excavated material is used except for the provisions for roadway excavation as provided by the contract. The Contractor shall replace at his own expense with other acceptable material all of that portion of the excavated material which was needed in the embankments, back fills, approaches, or otherwise. Charge for the materials so used will not be made against the Contractor. The Contractor shall not excavate or remove any material from within the Project location which is outside the grading limits, as indicated by the slope and grade lines, without written authorization. The Contractor will not be paid for the excavation so authorized and shall replace the excavated material at no cost to the Owner.

45. MAINTENANCE OF TRAFFIC

When the contract requires the maintenance of vehicular traffic on an existing road, street, or highway during the Contractor's performance of work that is otherwise provided for in the contract, plans, and specifications, the Contractor shall keep such road, street, or highway open to all traffic and shall provide such maintenance as may be required to accommodate traffic. The Contractor shall furnish erect, and maintain barricades, warning signs, flagmen, and other traffic control devices in conformity the requirements of the New Jersey Department of Transportation, unless otherwise specified herein. The Contractor shall also construct and maintain in a safe condition any temporary connections necessary for ingress to and egress from abutting property or intersecting roads, streets or highways.

On marine terminal projects it is the explicit intention of the contract that the safety of all persons, as well as the Contractor's equipment and personnel, is the most important consideration. It is understood and agreed that the Contractor shall provide for the free and unobstructed movement of cargo handling equipment and operators in the Marine Terminal Operations Areas with respect to its own operations and the operations of all his Subcontractors as specified in the Article titled "LIMITATION OF OPERATIONS."

With respect to his/her own operations and the operations of all his/her Subcontractors, the Contractor shall provide marking, lighting, and other acceptable means of identifying: personnel; equipment; vehicles; storage areas; and any work area or condition that may be hazardous to the operation of cargo handling equipment, fire-rescue equipment, or maintenance vehicles at the marine terminal.

The Contractor shall make his/her own estimate of all labor, materials, equipment, and incidentals necessary for providing the maintenance of cargo handling and vehicular traffic as specified in this subsection.

The cost of maintaining the pedestrian and vehicular traffic specified in this subsection shall not be measured or paid for directly, but shall be included in the various contract items.

46. VALUE ENGINEERING

The term proposal as used in this Article is construed to mean a Value Engineering proposal submitted by the Contractor for changing the Plans, Specifications, or other requirements of the Contract. The Value Engineering proposal shall conform to the following:

- A. Purpose and Scope - The intent of Value Engineering is to share with the Contractor any cost savings generated on the Contract as a result of a proposal or proposals offered by the Contractor and approved by the Owner. The purpose is to encourage the use of Contractor's ingenuity and experience in arriving at alternative, lower cost or time-saving construction methods other than those reflected in the Contract Documents, by the sharing of savings resulting therefrom. The proposals contemplated are those that could produce a savings to the Owner without, in the sole judgement of the Engineer, impairing essential functions and characteristics of the Project or a portion of the Work involved. They include but are not limited to safety, service life, stage construction, economy of operation, ease of maintenance, and desired appearance.
- B. Submittal of Initial Proposal - An initial proposal is required for all Value Engineering proposals and shall outline the general technical concepts associated with the proposal and the estimated savings which will result.

The initial proposal will be reviewed by the Owner and, if found to be conceptually acceptable, approval to submit a final proposal will be granted by the Owner. A finding of conceptual acceptability of the initial proposal in no way obligates the Owner to approve the final proposal. The Contractor shall have no claim against the Owner as a result of the rejection of any such final proposal.

- C. Submittal of Final Proposal - Final proposals will be considered only after Owner approval of the initial proposal in accordance with Subheading B above. Final proposals will not be considered if submitted after 50 percent completion of the Work has occurred, based on monthly estimates amounting to more than 50 percent of the total adjusted Contract price, unless the remaining Contract Time is one (1) year or more. As a minimum, the following materials and information shall be submitted with each final proposal plus any additional information requested by the Owner:
 - (1) A statement that the final proposal is submitted as a Value Engineering proposal.
 - (2) A description of the difference between the existing Contract requirements and the proposed change, and the comparative advantages and disadvantages of each, including considerations of safety, service life, economy of operations, ease of maintenance, and desired appearance.
 - (3) Complete plans, specifications, and calculations showing the proposed revisions relative to the original Contract features and requirements. All plans and engineering calculations shall bear the signature of a Professional Engineer licensed to practice in the State of New Jersey.
 - (4) A complete cost analysis indicating the final estimate costs and quantities to be replaced by the proposal, the new costs and quantities generated by the final proposal, and the cost effects of the proposed changes on operational, maintenance, and other considerations.

- (5) A specific date by which a Change Order or Supplementary Agreement adopting the final proposal must be executed so as to obtain the maximum cost reduction during the remainder of the Contract. This date must be selected to allow the Owner ample time, usually a minimum of 60 days, for review and processing a Change Order or Supplementary Agreement. Should the Owner find that insufficient time is available for review and processing, it may reject the final proposal solely on such basis. If the Owner fails to respond to the final proposal by the date specified, the Contractor shall consider the final proposal rejected and shall have no claim against the Owner as a result thereof.
 - (6) A statement as to the effect the final proposal has on the Contract Time.
 - (7) A description of any previous use or testing of the final proposal on another Owner project or elsewhere and the conditions and results therewith. If the final proposal was previously submitted on another Owner project, indicate the date, the project, and the action taken by the Owner.
- D. Conditions - Proposals will be considered only after Award of Contract and only when all of the following conditions are met:
- (1) The Contractor is cautioned not to base any bid prices on the anticipated approval of a proposal and to recognize that such proposal may be rejected. In the event of rejection, the Contractor is required to complete the Contract in accordance with the Plans and Specifications and the prices bid.
 - (2) All proposals, approved or not approved by the Owner for use in the Contract, apply only to the ongoing Contract or Contracts referenced in the proposal. The proposals shall become the property of the Owner and shall contain no restrictions imposed by the Contractor on their use or disclosure. The Owner will have the right to use, duplicate, and disclose in whole or in part any data necessary for the utilization of the proposal. The Owner retains the right to use any accepted proposal or part thereof on any other or subsequent project without any obligation to the Contractor. This provision is not intended to deny rights provided by law with respect to patented materials or processes.
 - (3) If the Owner already has under consideration certain revisions to the Contract which are subsequently incorporated in a proposal, the Owner will reject the Contractor's proposal and may proceed with such revisions without any obligation to the Contractor.
 - (4) The Contractor shall have no claim against the Owner for any costs or delays due to the Owner's rejection of a proposal, including but not limited to development costs, anticipated profits, or increased materials or labor costs resulting from delays in the review of such proposal.
 - (5) The Engineer will determine as to whether a proposal qualifies for consideration and evaluation. The Engineer may reject any proposal that requires excessive time or costs for review, evaluation and/or investigations, or which is not consistent with the Owner's design policies and basic design criteria for the Project.
 - (6) The Engineer may reject all or any portion of Work performed pursuant to an approved proposal if the Engineer determines that unsatisfactory results are being obtained. The Engineer may direct the removal of such rejected Work and require the Contractor to proceed in accordance with the original Contract requirements without reimbursement for any Work performed under the proposal, or for its removal. Where modifications to the proposal are approved in order to adjust to field or other conditions, reimbursement is limited to the total amount payable for the Work at the

Contract prices as if it were constructed in accordance with the original Contract requirements. Such rejection or limitation of reimbursement does not constitute the basis of any claim against the Owner for delay or for any other costs.

- (7) The proposal shall not be experimental in nature but shall have been proven to the Owner's satisfaction under similar or acceptable conditions on another Owner project or at another location acceptable to the Owner.
- (8) Proposals will be considered only if equivalent options are not already provided in the Contract Documents.
- (9) The proposal shall be made based on items of Work scheduled to be done by the Contractor. Anticipated cost savings based on revisions of utility relocations or other similar items to be done by others will not be considered. Proposals which may increase the cost of Work done by others will not be considered.
- (10) The savings generated by the proposal must be of sufficient significance to warrant review and processing.
- (11) If additional information is needed to evaluate proposals, this information must be provided in a timely manner, otherwise the proposal will be rejected. Such additional information could include, where design changes are proposed, results of field investigations and surveys, design computations, and field change sheets.

If the proposal is approved, the Contractor shall submit drawings, in Autodesk compatible CAD files and PDF digital files.

All plans and engineering calculations shall bear the signature of a Professional Engineer licensed to practice in the State of New Jersey. Proposals will not be considered that change the following:

- a. The types, thicknesses, or joint designs of a concrete, a bituminous, or a stabilized surface or base course.
 - b. The thicknesses of the unbound material immediately underlying a concrete, a bituminous, or a stabilized surface or base course.
 - c. The basic design of bridges, defined as the type of superstructure and substructure, span length type and thickness of deck, type of beam and arrangement, geometrics, width, and under clearance.
 - d. The basic design of retaining walls.
 - e. The basic design of overhead sign supports or breakaway sign supports.
 - f. The type of noise barriers.
- E. Payment - If the proposal is accepted, the changes and payment therefor will be authorized by Supplementary Agreement. Payment will be made as follows:
- (1) The changes will be incorporated into the Contract by adjustments in the quantities of Pay Items, agreed upon Extra Work Items or by Force Account, as appropriate, in accordance with the Specifications.
 - (2) The cost of the revised Work as determined from the aforementioned changes will be paid in accordance with GENERAL CONDITIONS Article "MEASUREMENT AND PAYMENT." In addition to such payment, upon Completion, the Owner will pay to the Contractor, under a separate Pay Item, 50 percent of the actual savings as reflected by the difference between the above as-built payment and the cost of the related construction required by the original Contract Documents computed at Contract bid prices. However, the Owner may disregard the Contract bid

prices if such prices do not represent the value of the Work to be performed or to be deleted.

- (3) The Owner's costs for review and processing of the proposal will not be deducted from the savings.
- (4) The Contractor's costs for development, design, and implementation of the proposal are not eligible for reimbursement.
- (5) The Contractor may submit proposals for an approved Subcontractor, provided that reimbursement is made by the Owner to the Contractor and that the terms of the remuneration to the Subcontractor are satisfactorily negotiated and accepted before the proposal is submitted to the Owner. Subcontractors may not submit a proposal except through the Contractor.

47. FINAL CLEANUP

Before final inspection and Completion, borrow and local material sources and all areas occupied by the Contractor in connection with the Work shall be cleaned of all rubbish, excess materials, temporary structures, and equipment, and all parts of the Work shall be left in an acceptable condition. If the Contractor fails to complete final cleanup within the time stated in the Specifications for the completion of the Contract or within such further time as may have been granted in accordance with the provisions of the Contract, the Contractor shall pay the Owner liquidated damages pursuant to GENERAL CONDITIONS Article "LIQUIDATED DAMAGES OR ACTUAL DAMAGES FOR DELAY."

48. RESERVED

49. RESERVED

CONTROL OF WORK

50. COMMUNICATIONS

Unless otherwise directed, all communications with the Owner shall be sent to the Engineer. Where communications are directed to persons other than the Engineer, a clear copy shall be sent to the Engineer.

51. THE OWNER'S PROJECT ADMINISTRATION

Information or services under the Owner's control shall be furnished by the Owner through the Engineer with reasonable promptness so as to avoid delay in the orderly progress of the work. All instructions to the Contractor shall be issued through the Engineer.

52. AUTHORITY OF THE ENGINEER

The Engineer shall be the Owner's representative during the construction period. His authority and responsibility shall be limited to the provisions set forth in these Contract Documents. The Engineer will decide all questions which may arise as to the quality and acceptability of the Work and shall have the Owner to reject defective work and materials whenever such rejection may be necessary to assure execution of the Contract in accordance with the intent of the Contract Documents. The Engineer will further decide all questions, which may arise as to the rate of progress of the Work as related to crews, equipment and work hours, interpretation of the Contract Documents, the acceptable fulfillment of the Contract on the part of the Contractor, and all questions as to compensation. All questions as to the interpretation of the Contract Documents shall be submitted to the Engineer in writing.

The Engineer shall have the authority to interpret project schedule requirements and to establish the necessary priorities for resolving conflicts between Contractors, and to enforce such measures as may be necessary to maintain overall project schedules. It is the intent of this Article that there shall be no delays in the progress of the critical elements of the project work, and the decision of the Engineer as rendered shall be promptly observed. The Engineer has the authority to suspend the Work wholly or in part pursuant to GENERAL CONDITIONS Article "SUSPENSION OF WORK" or "TEMPORARY SUSPENSION OF WORK" and to suspend partial payments under GENERAL CONDITIONS Article "PARTIAL PAYMENTS" due to the failure of the Contractor to correct conditions unsafe for the workers or the general public, for failure to carry out provisions of the Contract, or for failure to carry out orders. The Engineer may also suspend the Work wholly or in part for such periods as deemed necessary due to unsuitable weather, for conditions considered unsuitable for the prosecution of the Work, or for any other condition or reason deemed to be in the public interest.

53. DUTIES AND RESPONSIBILITIES OF THE ENGINEER

The Engineer is responsible for the administration of the Contract. This responsibility includes the authority to reject defective material and to suspend any and all the Work in accordance with GENERAL CONDITIONS Articles "SUSPENSION OF WORK" and "TEMPORARY SUSPENSION OF WORK." The Engineer will make periodic observations at the site of the project to determine the progress, quantity, and quality of the work and to determine, in general, if the work is proceeding in accordance with the intent of the Contract Documents. He shall not be required to make comprehensive or continuous inspections to check quality or quantity of the work. He shall not be responsible for construction means, methods, techniques, or procedures, or for safety precautions and programs in connection with the work. He shall not be responsible for the Contractor's failure to execute the work in accordance with Contract Documents. Observations made by the Engineer shall not relieve the Contractor of his obligation to conduct comprehensive inspections of the work and to furnish materials, to perform acceptable work, and to provide adequate safety precautions in conformance with the intent of the Contract Documents.

The Engineer will not be responsible for the acts or omissions of the Contractor, or any Subcontractor, or of the agents or employees of any Contractor or Subcontractor, or any other persons at the site or otherwise executing any of the work.

All claims by the Contractor arising from interpretation of or performance under the Contract Documents shall, in the first instance, be submitted to the Engineer, who shall issue his determination in writing within a reasonable period of time. If the Contractor considers that a determination made by the Engineer hereunder is not in accord with the meaning and intent of the Contract, the Contractor may, within fifteen (15) days from the receipt of the Engineer's determination, file with the Engineer a written objection to the Engineer's initial determination. The Contractor's written objection shall contain detailed arguments and all documentation necessary to support the objection. The Engineer shall consider and review the Contractor's written objection to the initial determination, with detailed supporting documentation, and render a final determination on the issue within a reasonable period of time. Failure to provide such detailed arguments and documentation shall be considered acceptance of the determination, and the determination shall become final and conclusive. Failure to file a written objection to the final determination, which requests a hearing before the Owner's Executive Director, within fifteen (15) days, shall be considered acceptance of final determination.

The Engineer's initial determination, the filing of the written objection thereto, and the Engineer's determination of such objection shall be a condition precedent to the right to request a hearing before the Owner's Executive Director, as provided for in Article "DISPUTES" of these GENERAL CONDITIONS. Thereafter, unless the Contractor and the Owner amicably resolve the matter, it shall be subject to the provisions of the Article "DISPUTES" of the GENERAL CONDITIONS.

54. INSPECTORS

The Owner may appoint (either directly or through the Engineer) such inspectors as the Owner deems proper, to inspect the materials furnished and the work performed for compliance with the Contract Documents. The Inspectors are authorized to inspect all Work. Such inspection may extend to all or any part of the Work and to the preparation, fabrication, or manufacture of the materials to be used. The Inspector is not authorized to alter or waive the provisions of the Contract. The Inspector is not authorized to issue instructions contrary to the Contract Documents or to act as foreman for the Contractor; however, the Inspector has the Owner to reject Work subject to confirmation with the Engineer. The Contractor shall allow access and furnish all reasonable assistance required by the Engineer or Inspectors for the proper inspection of the work.

55. INSPECTION BY CONTRACTOR

The Contractor shall observe and inspect the quality and accuracy of his own work and work executed by his Subcontractors. Deficiencies found in the work shall be corrected prior to requesting inspection by the Engineer.

Inspection by the Engineer shall not relieve the Contractor from any obligation to perform his work strictly in accordance with the Contract Documents. Defective work performed shall be removed and replaced by the Contractor at his own expense.

56. INSPECTION OF WORK

Each part or detail of the Work is subject to inspection by the Engineer. The Engineer shall be allowed access to all parts of the Work and shall be furnished with such information and assistance by the Contractor as is required to make a complete and detailed inspection. When the Engineer is in or about the site of the Work in the course of his employment, the Engineer is deemed conclusively to be an invitee of the Contractor. If the Contractor is not the Owner of the place where fabrication, preparation, or manufacture is in progress, the Owner thereof shall be deemed to be the agent of the Contractor with respect to the obligation assumed hereunder. The Contractor or his agent shall be responsible for the payment of claims for injuries to the Engineer due to negligence on the part of the said Contractor or his agent.

The Engineer may order any Work done without the Engineer's inspection to be removed and replaced at the Contractor's expense. Payment for the Work will be made and the uncovering, or removing, and the replacing of the covering, or making good of the parts removed, of the uninspected Work will be paid for as Extra Work only if all of the following conditions are met:

1. The Work removed, uncovered, and/or replaced proves to have been acceptable in accordance with the Contract Documents; and
2. The Contractor gave reasonable notice in writing to the Owner that the uninspected work was to be performed; and
3. The Contractor, in performing the uninspected work, did not do so in the face of a directive from the Owner that such work not be performed.

Projects financed in whole or in part with Federal funds are subject to inspection at all times by the Federal agency involved, or such other Federal agencies as the United States requires. Such inspection does not make the Federal Government a party to this Contract. When any unit of government or political subdivision or any railroad is to pay a portion of cost of the Work covered by the Contract, its respective representatives shall have the right to inspect the Work. Such inspection does not make any such unit of government or political subdivision or any such railroad a party to the Contract and shall in no way interfere with the rights of either party hereunder.

The Contractor is responsible for carrying out the provisions of the Contract at all times and for control of the quality of the Work regardless of whether an authorized Inspector is present or not. This obligation to perform the Work in accordance with the Contract Documents is not relieved by the observations of the Engineer in the administration of the Contract, nor by inspections, tests, or approvals by others. Work not meeting the Contract requirements shall be made good, and unsuitable Work may be rejected, notwithstanding that such Work had been previously inspected and approved by the Owner or that payment therefor has been included in an estimate.

57. QUALITY CONTROL & QUALITY ASSURANCE TESTING

Quality control testing: The Contractor shall be responsible for all quality control testing as required and as specified in the technical sections of the Project Manual. All testing shall be performed by an Independent Testing Laboratory hired by the Contractor and approved by the Engineer. The Independent Testing Laboratory shall not be subject to control, restriction, modification or limitation from the Contractor and/or the project sub-Contractors. The Independent Testing Laboratory shall be certified to perform the testing by the appropriate certifying agency where said certification is either a requirement of the technical specifications or is considered industry standard. All cost associated with quality control testing shall be borne by the Contractor, and no separate payment will be made to the Contractor for this testing. The Contractor shall include the cost of quality control testing in either his lump sum bid or in the various items of work to which the quality control testing applies.

Quality assurance testing: The Engineer, in his discretion, may choose to perform quality assurance testing to verify that the construction or components thereof are in accordance with the contract documents. Said quality assurance testing is not obligatory on the part of the Engineer nor does performance of said quality assurance testing in any way obviate the performance of quality control testing on the part of the Contractor. The Contractor shall provide the Engineer, unhindered access to the Project for the performance of said quality assurance testing and shall assist the Engineer when necessary in the retrieval of samples for quality assurance testing of materials.

Should quality assurance testing indicate that the Work or portions of the Work do(es) not meet the specifications, the defective portion of the Work shall be removed and reinstalled correctly without cost to the Owner. Costs associated with quality assurance testing when Work is deemed to be deficient shall be borne by the Contractor. The Owner shall deduct these costs from payments due the Contractor. Otherwise, all costs associated with quality assurance testing shall be borne by the Owner.

58. SPECIAL INSPECTION, TESTING, OR APPROVAL

Whenever the Engineer considers it necessary or advisable to ensure the proper implementation of the Contract Documents, the Engineer has Owner to require special inspection or testing of the Work in addition to that required elsewhere in the Contract Documents, whether or not such Work be then fabricated, installed, or completed. However, neither the Engineer's Owner to act under this Article, nor any decision made by the Engineer either to exercise or not to exercise such Owner, creates a duty or responsibility of the Engineer to the Contractor, any Subcontractor, or any of their agents or employees performing any of the Work.

If after commencement of the Work the Engineer determines that any Work requires special inspection, testing, or approval not provided for elsewhere in the Contract Documents, the Engineer will perform such inspection, testing, or approval using Owner facilities, by contracting with others for such services, or by instructing the Contractor by Field Order to order special inspection, testing, or approval. If such special inspection or testing reveals a failure of the Work to comply with the requirements of the Contract Documents or, with respect to the performance of the Work, with laws,

ordinances, rules, regulations, or orders of any public Owner having jurisdiction, the Contractor shall bear all costs thereof, including the Engineer's additional services made necessary by such failure. If tests reveal no such failure, the Owner will bear such costs, and a Supplementary Agreement will be negotiated.

59. CONFORMITY WITH CONTRACT DOCUMENTS

All Work performed shall be in conformity with the lines, grades, cross-sections, dimensions, and material requirements, including tolerances shown in the Contract Documents. The purpose of tolerances is to accommodate occasional minor variations from the middle portion of the tolerance range that are unavoidable for practical reasons. When a maximum or minimum value is specified, the production and processing of the material and the performance of the Work shall be so controlled that the Work shall not be preponderantly of borderline quality or dimension. Although measurement, sampling, and testing may be considered evidence of conformity, the Engineer will determine whether the Work deviates from the Contract Documents.

In the event the Engineer finds the Work not in conformance with the Contract Documents but that reasonably acceptable Work has been produced, the Engineer will determine if the Work is to be accepted and remain in place. In this event, the Engineer will document the basis of the acceptability of the Work and provide for an appropriate adjustment in the contract price for such Work as deemed necessary. If an appropriate adjustment cannot be negotiated, the Work shall be removed and replaced or otherwise corrected at no cost to the Owner.

In the event the Engineer finds the Work not in conformance with the Contract Documents, including tolerances resulting in an inferior or unsatisfactory product, the Work shall be removed and replaced or otherwise corrected at no cost to the Owner.

Neither the observations of the Engineer in the administration of the Contract, nor inspections, tests, or approvals by persons other than the Contractor relieves the Contractor from his obligation to perform the Work in accordance with the Contract Documents.

EXAMINATION OF QUESTIONED WORK

At the direction of the Engineer, the Contractor, at any time before Acceptance, shall remove or uncover specified portions of the finished Work, which the Engineer had previously inspected. If such work is found to be in accordance with the Contract Documents, the Owner will issue a Modification Order authorizing payment for the cost of examination and replacement. The Contractor shall restore said portions of the Work to the standard required by the Contract Documents. If such work is found to be not in accordance with the Contract Documents, the Contractor shall correct the defective work, and the cost of examination and correction of the defective work shall be borne by the Contractor. If any work should be covered up without approval or consent of the Engineer, it shall, if examination is required by the Engineer, be uncovered at the Contractor's expense.

60. UNNOTICED DEFECTS

Any defective work that may be discovered by the Engineer before Contract Completion, or before final payment has been made, or during the guarantee period, shall be removed and replaced by work which shall conform to the provisions of the Contract Documents. Failure on the part of the Engineer to condemn or reject unacceptable work shall not be construed to imply acceptance of such work.

61. REMOVAL OF UNACCEPTABLE AND UNAUTHORIZED WORK

All Work that does not conform to the requirements of the Contract is unacceptable unless otherwise determined acceptable under the provisions in GENERAL CONDITIONS Article "CONFORMITY WITH CONTRACT DOCUMENTS." Unacceptable Work, whether the result of poor workmanship, use of defective materials, damage through carelessness or any other cause, found to exist prior to Acceptance, shall be removed immediately and replaced in an acceptable manner at no cost to the Owner. Work shall not be done without lines and grades having been given by the Engineer or the Contractor as provided under GENERAL CONDITIONS Article "CONSTRUCTION STAKES, LINES, AND GRADES." Work done contrary to the instructions of the Engineer, Work done beyond the lines shown on the Plans, except as herein specified, or any Extra Work done without Owner is considered as unauthorized and will not be paid for under the provisions of the Contract. Work so done may be ordered removed or replaced at no cost to the Owner. If the Contractor fails to comply promptly with any order of the Engineer made under the provisions of this Article, the Engineer will have Owner to cause unacceptable Work to be removed or replaced by others and to deduct the costs thereof from any monies due or that may become due the Contractor.

62. RIGHT TO RETAIN DEFECTIVE WORK

If any part or portion of the work executed under this Contract shall prove defective, and if the defect in the same shall not be of sufficient magnitude or importance as to make the work dangerous or unsuitable, or if the removal of such work will create conditions which are dangerous or undesirable, the Owner has the right and Owner to retain such work and the Owner may make such deductions in the final payment therefor as may be just and reasonable. Acceptance of such work shall in no way negate the guarantee on such work as set forth in the Article "GUARANTEE" of these GENERAL CONDITIONS.

63. LATENT DEFECTS

The Owner reserves and retains all of his rights and remedies at law against the Contractor and his Surety for the correction of any and all latent defects discovered after the guarantee period.

64. PROJECT MEETINGS

The Engineer will conduct project meetings for the purpose of discussing and resolving matters concerning the various elements of the work. Time and place for these meetings and the names of persons required to be present will be as directed by the Engineer. The Contractor shall comply with these attendance requirements and shall also require, if needed, his Subcontractors to comply.

65. INDEPENDENT CONTRACTOR

The Contractor shall execute all work under this Contract as an independent Contractor and neither he nor his Subcontractors at any time shall be considered as an agent of the Owner or Engineer.

66. SUPERINTENDENCE

The Contractor shall designate in writing before starting Work, a competent, English-speaking Superintendent capable of reading and thoroughly understanding the Contract Documents, and thoroughly experienced in the type of construction being performed. The Contractor shall inform the Engineer in writing of the name, address, and the telephone number (day and night) of such representative and shall submit the representative's resume of qualifications, years of experience, and names of previous projects on which he has worked in a supervisory capacity. The Superintendent shall have the Owner to represent and act for the Contractor. The Contractor shall

not remove or replace his authorized representative without notifying the Engineer. In the event the Contractor's representative ceases to be in his employ, the name and qualifications of an alternate representative shall be submitted to the Engineer. An alternate to the Superintendent, with equal Owner and qualifications, may also be designated. The Superintendent or the alternate shall be present at the site of the Project at all times while Work is actually in progress on the Contract irrespective of the amount of Work subcontracted.

The Superintendent or the alternate shall have full Owner to execute orders or direction from the Engineer, without delay, and to promptly supply such materials, equipment, tools, labor, and incidentals as may be required. When Work is not in progress and during periods when Work is suspended, arrangements acceptable to the Engineer shall be made for any emergency Work, which may be required.

Whenever the Superintendent or the alternate is not present on the site or at the location of any particular part of the Work where it may be desired to give direction, the Engineer may suspend all of the Work or the particular Work in reference until the superintendent or the alternate is present. Such suspension shall not be the basis of any claim against the Owner.

67. RECEPTION OF ENGINEER'S DIRECTIONS

The Superintendent, or other duly authorized representative of the Contractor, shall represent the Contractor in all directions given to him by the Engineer, and such directions, instructions, and other communications given shall be as binding as if given to the Contractor. Directions of major importance will be confirmed in writing, as will all directions, if requested by the Contractor.

68. ACCESS TO WORK

The Contractor shall provide to the Owner, Engineer, other Contractors working on the project, authorized government agents, and their representatives, at all times, safe access to the work wherever it is in preparation or progress. Such persons shall inform the Contractor of their visits and the Contractor shall provide facilities for such access and for such inspection in keeping with his responsibility for construction site control, including maintenance of temporary and permanent access.

69. AUTOMATICALLY CONTROLLED EQUIPMENT

Whenever equipment is required to be operated automatically under the Contract and a breakdown or malfunction of the automatic controls occurs, the equipment may be operated manually or by other methods only for the remainder of the working day on which the breakdown or malfunction occurs, provided this method of operation produces results which otherwise meet the Specifications.

70. LOAD RESTRICTIONS

Within the limits of the Project, the operation of equipment of such weight or so loaded as to cause damage to structures, the roadway, Port facilities, or to any other type of construction will not be permitted. Hauling of materials over the base course or surface course under construction shall be limited as directed. No loads will be permitted on a concrete surface course, base course, or structure before the expiration of the curing period. In no case shall legal load limits be exceeded when equipment is used for hauling to and from the Project site unless permitted in writing by the Director of Motor Vehicles and the South Jersey Port Corporation. The Contractor shall be responsible for all damage done by his hauling equipment.

The Owner will monitor the Contractor's observance of the legal load limits in accordance with the following:

1. For trucks with weigh tickets, a certified weigh ticket shall be furnished with each load.
2. For trucks without weigh tickets that are hauling material for items of 5,000 cubic yards or more, a list of trucks and their motor vehicle classifications shall be furnished prior to the start of work and shall be updated at the start of each construction season thereafter. A certified weigh ticket showing the gross weight shall be furnished with the first load for each truck for each item. The Engineer shall be notified in advance so that the first load can be documented by measurements and photographs.
3. For trucks hauling bituminous concrete from automated batch plants, a list of trucks including the certified tare weights and maximum allowable load for each shall be furnished prior to the start of work. This list shall be kept current and include all trucks to be used throughout the duration of the Project. Failure to provide this information will be cause for rejection of material.
4. For Portland cement concrete delivery trucks, a list of trucks including the certified tare weight and the maximum cubic yard load for each shall be furnished prior to the start of work and shall be updated at the start of each construction season thereafter.

Any truck found to be in excess of the legal load limit may have that load of material rejected for use on the Project. Repeated violations may be cause for suspension of operations until the condition is remedied to the satisfaction of the Engineer. No payment will be made for any material in excess of the legal truck load limit.

71. MAINTENANCE DURING CONSTRUCTION

Except as provided for below, the Contractor shall be responsible for maintenance within the Project limits until Acceptance pursuant to GENERAL CONDITIONS Article "COMPLETION AND ACCEPTANCE." This maintenance shall consist of continuous and effective work prosecuted day by day, with adequate equipment and forces to the end that the roadway or Port facility is kept in satisfactory condition at all times.

In the case of a Contract requiring the placing of a course upon a course or subgrade previously constructed, the Contractor shall maintain the previous course or subgrade during all construction operations.

On any section opened to traffic, whether provided for in the Contract Documents or opened as directed, any damage to the roadway due to the Contractor's operations shall be repaired at no cost to the Owner.

The Contractor shall not be responsible for removal of ice or snow from sections of roadways or Port facility opened to traffic or for damage to the Project caused by the operation of snow plows or other snow removal or de-icing operations carried on by others under the supervision or direction of the Owner or of the various counties and municipalities.

The Contractor shall not be responsible for mowing unless an item for mowing is scheduled in the Bid Form or an item directs the Contractor to perform mowing.

All costs for maintenance during construction shall be included in the various Pay Items scheduled in the BID FORM.

72. FAILURE TO MAINTAIN ROADWAY

If the Contractor at any time fails to comply with the provisions of GENERAL CONDITIONS Article "MAINTENANCE DURING CONSTRUCTION," the Engineer will immediately notify the Contractor of such noncompliance. If the Contractor fails to remedy unsatisfactory maintenance within 24 hours after receipt of such notice, the Engineer may proceed to maintain the Project and deduct the entire cost of this maintenance from any monies due or that may become due the Contractor.

73. CONSTRUCTION STAKES, LINES, AND GRADES

The Owner shall only furnish benchmarks for vertical control and monuments for horizontal control.

The Contractor shall provide all survey services required in connection with the layout for construction of the Project, using the control points and data furnished by the Owner. The Contractor shall furnish all necessary qualified personnel, registered in the State of New Jersey, and adequate equipment to preserve such controls throughout the duration of the Contract and shall lay out all of the lines and grades necessary for the complete construction of the Project. Also, furnish the Engineer with any assistance required for checking lines, grades, and measurements established (other than the Owner established survey points) and necessary for the performance of the work. The Owner does not assume responsibility for the performance of the work as a consequence of this checking.

The Contractor shall make all necessary computations to establish the exact position of all the Work from the control points, which are shown on the Plans or furnished by the Owner. All the Work shall be referenced to baselines which the Contractor shall establish from the control points, re-establish when necessary, and maintain throughout the life of the Contract so as not to delay the Engineer from making necessary preliminary, interim, and final measurements and from checking the Contractor's layout if the Engineer so desires.

The Owner will lay out the work to be done by utility companies using the baselines established by the Contractor. The Engineer will notify the Contractor, in writing, not less than five (5) days in advance of when the baselines shall be established.

The Contractor shall be responsible for the preservation of all control points furnished by the Owner for its use in staking out the Work. If such control points are damaged, lost, displaced, or removed, they shall be reset at no cost to the Owner.

The Contractor shall provide and maintain offset stakes from each main roadway baseline, from each ramp, or turnaround baseline, and from each local road baseline, at each station, and outside the limits of grading and construction.

Each stake shall be identified and marked to show the offset distance from the baseline, and the Contractor shall furnish grade sheets showing the cut or fill to the finished profile lines with reference to the offset stakes. Grade sheets for construction of subbase and underlayer preparation shall also include calculations to establish the typical cross-section from the profile grade stake. The Contractor shall provide adequate and accurate offset lines during such construction that require occupation of the baseline points by construction operations.

The Contractor shall be responsible for maintaining the points it has established. Any error or apparent discrepancies found in the Plans or Specifications shall be called to the Engineer's attention in writing for interpretation prior to proceeding with the Work. The Contractor shall be responsible for the finished Work conforming to the lines and grades called for on the Plans, and the Contractor shall correct all errors caused by his personnel at no cost to the Owner.

Attention is directed to the need for caution in laying out and constructing storm drains or headwalls to ascertain that these items do not encroach on private property where easements have not been obtained.

Prior to the beginning of any construction work which requires accurate elevations, rough grading and clearing not included, the vertical control network shall be verified in the field by the Contractor's survey crew. The Contractor shall be responsible for the verification work. In most cases, some vertical control is provided for the Project as shown on the Plans. This control must be verified in the field using, at a minimum, third-order, Class I, procedural standards and equipment. In addition, supplemental benchmarks may be required to provide a denser network for efficient construction surveys. Any discrepancies or errors shall be brought to the attention of the Engineer for resolution prior to proceeding with the Work. The Contractor shall provide the Owner with the field notes and calculations of the field verification of the vertical control. The Contractor, in addition, shall provide to the Engineer a list of the existing and new benchmark elevations which will be used on the Project.

The Contractor's survey crew shall be responsible to recover, verify, and check the horizontal control shown on the Plans. The Contractor shall be responsible for all the verification work. The field verification shall be performed at the beginning of the Project, as the control line(s) establish(es) a network of control points which are the basis for all subsequent horizontal work on the Project.

The Contractor's survey crew shall use, at a minimum, third-order, Class I, accuracy and procedures to establish and re-establish the horizontal control line. The Project baseline(s) shall be verified and established during the early phases of the Project. This baseline establishes a network of control monuments which are the basis for all subsequent horizontal surveys on the Project. Any discrepancies or errors shall be brought to the attention of the Engineer for resolution prior to proceeding with the Work. The Contractor shall provide the field notes and calculations of the field verification work.

No separate payment will be made for Contractor's Survey. The cost of the construction stakes, lines, and grades shall be absorbed by the Contractor in the prices bid for the various items of work.

74. COOPERATION BY CONTRACTOR

The Contractor shall give the Work the constant attention necessary to facilitate the progress thereof, and shall cooperate with the Engineer, the Owner's Inspectors, and other Contractors in every way possible.

The Contractor shall be solely responsible for all construction means, methods, techniques, and procedures; and he shall provide adequate safety precautions, coordinate all portions of his own work with the work of his Subcontractor, schedule his work to avoid conflict with the Owner's operations, and cooperatively coordinate his work with the work of other prime Contractors performing work for the Owner.

When the Contractor is comprised of two (2) or more persons, firms, partnerships, or corporations functioning on a joint venture basis, said Contractor shall designate in writing, before starting Work, the name of one (1) individual who shall have the Owner to represent and act for the joint venture.

75. COOPERATION BETWEEN CONTRACTORS

The Owner reserves the right at any time to contract for and perform other or additional work on or near the Project site. When separate contracts are let within the limits of the Project, or in areas adjacent thereto, the Contractor shall conduct his Work so as not to interfere with or hinder the

progress or completion of the work being performed by other Contractors. Moreover, the Contractor assumes the positive obligation of cooperating with such other Contractors and coordinating his activities with theirs. If there is a difference of opinion as to the respective rights of the Contractor and others doing work within the limits of or adjacent to the Project, the Engineer will decide as to the respective rights of the various parties involved in order to secure the completion of the Owner's Work in general harmony and in a satisfactory manner. The decision of the Engineer is final and binding and is not cause for claims by the Contractor for additional compensation.

The Contractor shall assume all liability, financial or otherwise, in connection with his Contract, and hereby waives any and all claims against the Owner for additional compensation that may arise because of inconvenience, delay, or loss experienced by it because of the presence and operations of other Contractors working within the limits of or adjacent to the Project.

The Contractor shall arrange his Work and shall place and dispose of the materials being used so as not to interfere with the operation of the other Contractors within the limits of the Project or adjacent thereto. The Contractor shall join his Work with that of the others in an acceptable manner and shall perform it in proper sequence to that of the others.

The Contractor is not responsible for damage to Work performed on the Contract or on other contracts within or adjacent to the site of the Project that may be caused by or on account of the work of other Contractors. The Contractor is responsible for any damage done or caused by his Work or forces to the work performed by other Contractors within or adjacent to the site of the Project, and the Contractor shall repair or make good any such damage in a manner satisfactory to the Engineer and at no cost to the Owner.

The provisions of this Article also apply to utilities and their Contractors working on the Project site or adjacent thereto.

76. COOPERATION WITH UTILITIES

The Contractor shall cooperate with the owner of any public or private utility service, or a utility service of another government agency that may be authorized by the Owner to construct, reconstruct or maintain such utility services or facilities during the progress of the work. In addition, the Contractor shall control his/her operations to prevent the unscheduled interruption of such utility services and facilities.

To the extent that such public or private utility services, or utility services of another governmental agency are known to exist within the limits of the contract work, the approximate locations have been indicated on the plans.

It is understood and agreed that the Owner does not guarantee the accuracy or the completeness of the location information relating to existing utility services, facilities, or structures that may be shown on the plans or encountered in the work. Any inaccuracy or omission in such information shall not relieve the Contractor of his/her responsibility to protect such existing features from damage or unscheduled interruption of service. Any damage shall be immediately repaired on a continuous basis until service is restored.

Within the site of the Project there may be public utility structures, and notwithstanding any other clause or clauses of the Contract, the Contractor shall not proceed with his Work until it has made inquiry at the offices of the Engineer, the utility owners and municipal authorities, or other owners to determine their exact location. The Contractor shall notify, in writing, the utility owners and municipalities or other owners involved of the nature and scope of the Project, and of his operations that may affect their facilities or property. Two (2) copies of such notices shall be sent to the Engineer. The Contractor shall also comply with the State's Underground Facility Protection Act

and notify the State's One Call System and identify itself as the Owner's Contractor and specify the route and section number of the Project before performing Work on the Project. The One Call System can be reached by calling 1-800-272-1000.

The Contractor shall make a written request to the Engineer ten (10) working days in advance of the notice called for in the schedule to notify utility owners to proceed with each utility item. The Contractor's failure to give the ten (10) working days' notice hereinabove provided shall be cause for the Engineer to suspend the Contractor's operations in the general vicinity of a utility service or facility. The Contractor shall guarantee the site availability for utility operations. The Engineer will notify the utility owners to proceed if in the Engineer's opinion the site will be available for a particular item of utility work. In addition to the general written notification hereinbefore provided, it shall be the responsibility of the Contractor to keep such individual owners advised of changes in his/her plan of operations that would affect such owners.

Where the outside limits of an underground utility service have been located and staked on the ground, the Contractor shall be required to use excavation methods acceptable to the Engineer within 3 feet of such outside limits at such points as may be required to ensure protection from damage due to the Contractor's operations.

Utility items constructed or installed by the Contractor for a utility owner must meet the owner's specifications. The owner shall be given the opportunity to inspect the actual material to be installed as well as the installation. The Contractor shall notify the utility owner ten (10) days in advance of the beginning of construction of the utility items.

Electrical installations of the Owner constructed either before or as part of the Contract shall be considered a utility, and all provisions of this Article shall be applicable. The Contractor shall protect, support, and secure all in place utility facilities so as to avoid damage to them and their interruption of service. The Contractor shall satisfactorily maintain the flow in drains and sewers at all times.

The Contractor shall not move utility facilities without the owner's written consent, and the facilities shall be as safe and permanent at Completion as they were before the Contractor's involvement. In the event the Contractor damages a utility facility, the Contractor shall notify the owner immediately and the owner may require the damage to be repaired at the Contractor's expense. The Contractor shall pay for the repair of utility facilities damaged by the Contractor within 30 days of the completed repair or the Owner may retain sufficient monies due or about to be due the Contractor to reimburse the owner for the repair of its facility. The Contractor shall be responsible to repair house services damaged by the Contractor's operation and must have the repair performed by competent mechanics.

The Contractor shall permit the utility owners or their agents access to their facilities at all times and shall cooperate with them in performing their work. The Contractor shall be cognizant that where joint use poles or duct banks are used the time frames for work performed by each user are cumulative.

Should the Contractor, solely for his own convenience, cause the utility company to incur costs not covered by the utility agreement, or delay the utility company, or incur costs without prior written approval of the Resident Engineer, the Contractor shall be responsible for these costs.

The Contractor shall cooperate with the utility owners concerned and shall notify them, through the Engineer, not less than ten (10) days in advance of the time it proposes to perform any Work that may endanger or affect their facilities. The Contractor assumes the obligation of coordinating his activities with those of the utilities.

For the purpose of establishing the exact location of subsurface utilities, the Engineer may direct the excavation of test pits. Failure of the Engineer to direct the digging of test pits does not relieve the Contractor of his responsibilities regarding the protection and preservation of utilities.

It is understood and agreed that the Contractor has considered in his bid all of the permanent and temporary utility facilities in their present or relocated positions as may be shown on Plans, as described in Specifications and as revealed by his site investigation; is aware that utility company service demands, adverse field conditions and emergencies may affect the Owner's ability to comply with the proposed schedules for utility work; and is cognizant of the limited ability of the Owner to control the actions of the utilities, including the actions of railroads, and has made allowances in his bid that no further compensation or extensions of Contract Time will be granted for delays, inconvenience or damage sustained by the Contractor due to any interference from utility facilities or the operation of moving them.

In addition to the foregoing provisions, the following specific provisions relate to railroads only:

- A. Railroad Traffic and Property - Where the Project includes Work across, over, under, or adjacent to railroad tracks or railroad right-of-way, the Contractor shall safeguard the traffic, tracks, and appurtenances, and other property of the railroad which may be affected by his work. The Contractor shall obtain the railroad's approval of the method of construction and timing of the Work. The Contractor shall comply with the regulations of the railroad relating to the Work, shall keep tracks clear of obstructions, and shall provide barricades, warning signs, lights, or other safety devices as required by the railroad. Payment for such safety devices will be made in accordance with Traffic Control Item(s).

All Work done within the railroad right-of-way is subject to the approval of the railroad company in matters affecting operations, railroad property, safety and train operation. The safety and continuity of railroad operation shall be the first priority when working in proximity to the railroad. The Contractor and Subcontractors shall protect and safeguard railroad interest at all times and arrange their work to avoid interruption of train movements and damage to facilities of the railroad. Railroad approval does not release the Contractor from responsibility or liability for any damage which the railroad may suffer, or for which the Contractor may be held liable, by the acts of the Contractor or those of his Subcontractors or employees.

The Contractor shall develop a schedule with the railroad for his work within the railroad right-of-way and submit a copy of the schedule to the Resident Engineer.

The Contractor shall give written notice to the railroad and the Resident Engineer not less than 14 days in advance of when he or his Subcontractors shall start Work within the railroad right-of-way, or other Work which may affect railroad property, in order that necessary arrangements may be promptly made to protect railroad property. In the event the Contractor does not start work on the scheduled date, through no fault of the railroad, and the railroad incurs costs resulting from the Contractor's request for the railroad services, the Owner will reimburse the railroad, and these costs will be deducted from partial or final payments to be made to the Contractor. If the Contractor does not submit to the Resident Engineer a copy of the notice to the railroad and the Contractor performs the Work within the railroad right-of-way for which the railroad incurs costs, the Owner will reimburse the railroad and these costs will be deducted from partial or final payments to be made to the Contractor.

Fouling of railroad facilities track, power lines, and signal systems occur when the railroad parameters for normal operation are jeopardized because of obstructions in close proximity to the facilities. The Contractor shall obtain from the railroad its fouling parameters for the Work site and observe the railroad's regulations concerning fouling. Construction equipment or material shall not be stored or operated within the fouling distance of the railroad facilities without written permission of the operating railroad.

Equipment used on and adjacent to the railroad right-of-way shall be in first class condition so as to fully prevent any failure that might cause delay in the operation of trains or damage to railroad facilities. Contractor equipment is subject to railroad inspection at all times and shall not stand or be put in operation adjacent to the track without first obtaining permission from the railroad.

The railroad company may assign inspectors or engineers during the time the Contractor is engaged in Work on railroad property for the general supervision of construction operations, to ensure adherence to the Contract documents and applicable railroad requirements, and to ensure the use of approved construction methods. The salary and expense of said inspectors or engineers and the cost of any other engineering services furnished by the railroad will be paid directly to the railroad by the Owner in accordance with the Railroad Utility Agreement. The Owner will also reimburse the railroad for Project related costs to be incurred by the railroad as set forth in the Railroad Utility Agreement.

Should the Contractor, solely for its own convenience, cause the railroad to incur costs not covered by the railroad agreement or delay the railroad, or incur costs without prior written approval by the Resident Engineer, the Contractor shall be responsible for these costs. The Owner will reimburse the railroad for the Contractor generated costs and deduct these expenses from partial or final payment due the Contractor.

- B. Railroad Insurance - The applicable insurance provisions are as specified in the Specifications for Railroad Insurance.

77. SAFETY

The Contractor shall be solely and completely responsible for conditions at the jobsite, including safety of all persons (including employees) and property during execution of the work. This requirement shall apply continuously and not be limited to normal working hours. Project safety provisions shall conform to U.S. Department of Labor (OSHA), the New Jersey Occupational Safety and Health Act, and all other applicable laws including those that may be specified in other parts of these Contract Documents and shall in any event comply with the common law standards of due care. Where any of these are in conflict, the more stringent shall apply. The Contractor's failure to thoroughly familiarize himself with these safety provisions shall not relieve him of responsibility.

SAFETY REQUIREMENTS

The Contractor shall adhere to the following safety requirements for all projects.

The Contractor shall take all precautions necessary to insure the safety of the public as well as his own equipment and personnel. The Contractor shall obey all instructions as to routes to be taken by equipment traveling within the Port area and keep all such equipment marked with a three foot (3') checkered orange and white flag. Equipment not actually in operation shall be kept clear of

aircraft movement areas and designated restricted areas. The Engineer must approve all equipment storage locations.

The Contractor will not be permitted to leave any trenches or other excavations open overnight, on weekends, or at other times when the Contractor's workmen are not on the site. If it is absolutely necessary to leave a trench or excavation open when approved by the Engineer, the Contractor shall barricade and cover the opening to the complete satisfaction of the Engineer. The Contractor may be required to use covers over such open excavation, which will withstand the wheel load of the heaviest vehicle using the Port facilities.

The Contractor shall take all necessary precautions to prevent fires adjacent to the work, and he shall prevent the spread of fires to areas outside the limits of the work. He shall provide adequate facilities for extinguishing fires and shall safely dispose of combustible materials off Port property.

Any signs, lights, signals, temporary walkways, traffic control, portable flashing lights, Port breakaway barriers, and other devices which may be required for safe traffic control shall be provided and maintained by the Contractor during the course of the work, subject to the approval of the Engineer.

Air traffic will continue to use existing runways and taxiways of the Port during the work under this Contract is being performed. The Contractor shall at all times conduct his work so as to create no hindrance, hazard, or obstacle to air traffic using such portions of the Port as are not officially closed to air traffic, and must, at all times, conduct the work in conformance with the requirements of the Port Manager. The Contractor is cautioned that he should not have any men or equipment within 280' of either runway centerline when the runway is open for operations. Any inconvenience occurring is assumed to be a subsidiary obligation of the Contractor and the cost shall be absorbed in the unit prices bid for the various items of work.

Port hazard marking shall be furnished, installed and maintained by the Contractor, in accordance with "Safety on Ports During Construction Activities" contained in an Appendix in the Specifications.

The Contractor shall hold harmless the Owner, the Engineer, and their respective agents or representatives from any and all claims for damages, costs, expenses, judgement or decrees resulting from negligence on the part of the Contractor, or his, or their, or its agent or employees in conducting the work as required by this Contract.

The cost of the Port Safety Requirements shall be absorbed by the Contractor in the prices bid for the various items of work.

78. PROTECTION OF WORK AND PROPERTY AND SECURITY

The Contractor shall, at all times, safely guard all property from injury or loss in connection with work performed under this Contract. All passageways, guard fences, lights, and other facilities required for protection by Federal, State or local laws shall be provided and maintained.

The Contractor shall protect his work and materials from damage due to the nature of the work, the elements, adjacent construction operations, or from any cause whatsoever until the completion and acceptance of the work. All loss or damages arising out of the nature of the work to be done under these Contract Documents shall be borne by the Contractor.

79. RESPONSIBILITY OF CONTRACTOR TO ACT IN EMERGENCY

In case of an emergency that threatens loss or injury of property or safety of life, the Contractor shall act, without previous instructions from the Owner or Engineer, as the situation may warrant. The Contractor shall immediately inform the Engineer of the emergency action taken. Any claim for compensation by the Contractor, together with substantiating documents in regard to expense, shall be submitted to the Engineer and the amount of compensation, if any, shall be determined by agreement prior to the issuance of a Modification Order. However, if the emergency is created or aggravated by the Contractor, he shall be liable for the resulting damages. If the Contractor fails to take the necessary action as required by such an emergency, the Owner may assign another Contractor or use his own forces to perform the emergency work.

80. PARTIAL ACCEPTANCE

If at any time during the prosecution of the Project the Contractor completes a unit or portion of the Project, such as a structure, an interchange, or a section of road, or pavement, or runway, or taxiway, the Contractor may request the Engineer to make final inspection of that unit. If the Engineer finds upon inspection that the unit has been satisfactorily completed in compliance with the Contract, the Engineer may accept that unit as being completed, and the Contractor may be relieved of the responsibility of doing further Work on or maintaining that unit or portion of the Project. The Engineer reserves the right to reject the request made by the Contractor, if the Engineer determines that the unit or portion of the Project should not be the subject of a partial acceptance. Such partial acceptance shall in no way void or alter any of the terms of the Contract, including GENERAL CONDITIONS Articles "RISKS ASSUMED BY THE CONTRACTOR", nor shall it be construed as relieving the Contractor of full responsibility for making good defective work or materials found at any time before Acceptance pursuant to GENERAL CONDITIONS Article "COMPLETION AND ACCEPTANCE."

81. SUBSTANTIAL COMPLETION DATE

When the Contractor considers that the work, or a designated portion thereof which is acceptable to the Owner, is substantially complete, the Contractor shall prepare and submit to the Engineer a list of items to be completed or corrected and request an inspection for Substantial Completion. The failure to include any items on such list does not alter the responsibility of the Contractor to complete all work in accordance with the Contractor Documents.

If, however, the inspection discloses that the Work is not substantially completed to the Engineer's satisfaction, the Engineer will give the Contractor the necessary instructions for completion and correction of same, and the Contractor shall immediately comply with and execute such instructions. Upon completion and correction of the Work, the Contractor shall re-notify the Engineer and another inspection will be made.

When the Engineer on the basis of the inspection determines that the work or that designated portion of the work is substantially complete the Engineer; shall state the responsibilities of the Owner and the Contractor for security, maintenance, heat utilities, damage to the work, and insurance; and shall fix the time within which the Contractor shall complete the items listed therein.

Guarantees required by the Contract Documents shall commence on the date of the Substantial Completion of the Work or designated portion thereof, unless otherwise provided in the Certificate of Substantial Completion. The Certificate of Substantial Completion shall be submitted to the Owner and the Contractor for their written acceptance of the responsibilities assigned to them in such Certificate.

The issuance of a Certificate of Substantial Completion for any part of the work shall not relieve the Contractor of his obligation to promptly remedy any omissions and latent or unnoticed defects in the work covered by the Certificate of Substantial Completion.

Upon substantial completion of the work, an amount retained may be paid to the Contractor. When the work has been substantially completed, except for work which cannot be completed because of weather conditions, lack of materials, or other reasons which in the judgment of the Owner are valid reasons for non-completion, the Owner may make additional payments, retaining at all times an amount sufficient to cover the estimated cost of the work still to be completed or, in the alternative, may pay out the entire amount retained and receive from the Contractor guarantees in the form of a bond or other collateral sufficient to ensure completion of the work. The application for payment at substantial completion shall be accompanied by all documentation called for in the Contract Documents and such other data and schedules as the Owner may reasonably require, together with complete and legally effective releases or waivers (satisfactory to the Owner) of all liens arising out of or filed in connection with the work. In lieu thereof and as approved by the Owner, the Contractor shall furnish receipts or releases in full; an affidavit of the Contractor that the releases and receipts, including all labor, services, material and equipment for which a lien could be filed, and that all payrolls, material and equipment bills, and other indebtedness connected with the work for which the Owner or his property might in any way be responsible, have been paid or otherwise satisfied; and consent of the Surety, if any, to this payment.

The Owner shall have the right to restrict the Contractor's use of the occupied portion of the work after the date of Substantial Completion, but the Owner shall allow the Contractor reasonable access to complete or correct items required by the Contract Documents.

82. COMPLETION AND ACCEPTANCE

Upon receipt by the Engineer of written notice from the Contractor that the Work has reached Completion and is ready for final inspection and Acceptance, the Engineer will promptly make such inspection. When such inspection indicates that the Work is to be in compliance with the Contract, the Engineer will promptly issue a Certificate of Completion stating that, to the best of his knowledge, information, and belief, and on the basis of observations and inspections, the Work has been completed in accordance with the terms and conditions of the Contract. If, however, the final inspection discloses that the Work has not reached Completion, the Engineer will give the Contractor the necessary instructions for the correction of deficiencies, and the Contractor shall immediately comply with and execute such instructions. Upon correction of the deficiencies, the Contractor shall re-notify the Engineer, and another inspection will be made. This procedure is to be repeated until a Certificate of Completion is issued.

At the request of the Contractor, the Engineer may issue a Certificate of Completion without receiving all required documents, certificates, or proofs of compliance. The Contractor's request must satisfactorily establish that the Contractor could not reasonably and in good faith provide some of the required documents, certificates, or proofs of compliance at a time contemporaneous with Completion and with the Project being ready for use by the Owner to the degree contemplated by the Contract. In such instances where a Certificate of Completion is issued, the Contractor shall expeditiously attempt to provide the exempted document, certificate, or proofs of compliance. Final payment will not be made, however, until all such documents, certificates, and proofs of compliance have been satisfactorily executed and delivered to the Engineer.

The Certificate of Completion is issued establishing Completion as of the date of the notice or re-notice from the Contractor. If the Executive Director concurs in the Certificate of Completion, the Contractor will be notified of Acceptance and the date thereof.

After Acceptance, the Contractor is relieved of the duty of maintaining and protecting the Work as a whole, and is not required to perform any further Work thereon. In addition, the Contractor is relieved of his responsibility for damage to the Work, which may occur after Acceptance. However, nothing herein shall be construed to limit the provisions of GENERAL CONDITIONS Articles "RISKS ASSUMED BY THE CONTRACTOR," "INSURANCE AND LIABILITY," and "NO WAIVER OF RIGHTS."

83. RESERVED

84. RESERVED

CONTRACT DOCUMENTS

85. PLANS AND SPECIFICATIONS

The Plans consist of general drawings and show such details as are necessary to give a comprehensive idea of the construction contemplated. The Plans show details of all structures, lines, grades, typical cross-sections and/or roadway, runway or taxiway location and design of all structures, and a summary of items appearing on the Proposal Form. The Contractor shall keep one (1) set of Plans available on the Project site at all times. All alterations affecting the requirements and information given on the Plans will be authorized in writing.

Omissions from the Plans or Specifications of details of Work which are manifestly necessary to carry out the intent of the Contract Documents, or which are customarily included, shall not relieve the Contractor from including such omitted details of Work, but they shall be included as if fully and correctly set forth and described.

86. ADDITIONAL CONTRACT DOCUMENTS

The Engineer will furnish to the Contractor on request and free of charge, three (3) copies of the Contract Documents. Additional copies of Contract Documents may be obtained on request by paying the actual cost of supplying the additional Contract Documents.

87. SUPPLEMENTING DRAWINGS, INSTRUCTIONS, WORKING DRAWINGS AND CATALOG CUTS

Upon request, the Engineer may furnish, with reasonable promptness, additional instructions by means of supplementing drawings or otherwise if, in the Engineer's opinion, such are required for the proper execution of the work and are in accordance with the requirements of the Contract Documents. All such instructions will be consistent with the terms and become a part of the Contract Documents. The purpose of these instructions is to provide further explanation of the work. If, in the opinion of the Engineer, additions or deletions to the work are identified in these instructions, such additions or deletions shall be made to the Contract by a Change Order as defined in Article "CHANGES" of these GENERAL CONDITIONS.

The Contractor shall make all working drawings, which may be required in addition to the Contract Drawings or in addition to any other drawings, which the Engineer may issue in supplementing the Contract Drawings.

The specific requirements elsewhere set forth in the Specifications for furnishing working drawings for any particular portion of the Contract shall not limit the obligation of the Contractor to furnish working drawings for any other portion when so required by the Engineer.

In preparing the working drawings, the Contractor may adopt a sheet size of 24 x 36 inches. All sheets thereafter of a similar nature shall be of the same size as the adopted. Each drawing shall have a margin on the top, bottom and right-hand side of one-half inch (.5") and on the left-hand side a margin of one and one-half inch (1.5").

Before using any working drawings, the Contractor shall submit nine (9) blueprints thereof (or more if requested) for the approval of the Engineer. Within fourteen (14) calendar days after receipt of the prints, the Engineer shall approve the same or require corrections or additions to be made thereon. If additions or corrections are required, the Engineer shall return within the fourteen (14) calendar day period three (3) of the nine (9) blueprints submitted and the Contractor shall make the corrections or additions shown thereon to be made. He shall resubmit nine (9) blueprints showing the drawing corrected as required. Each drawing shall be corrected as required until the approval of the Engineer is obtained. After each re-submission, the Engineer shall have a similar period of fourteen (14) calendar days in which to approve corrections.

As soon as approval has been given to any working drawing or shop bill, the Contractor shall within five (5) days send to the Engineer nine (9) prints, except that when the Engineer specifically so directs twelve (12) prints shall be sent. After approval thereof, no change will be permitted thereon unless approved in writing by the Engineer.

Before final payment for the Work is made, the Contractor shall furnish to the Engineer one (1) set of working drawings, all clearly revised, completed and brought up to date showing the permanent construction as actually made. These working drawings shall be either Autodesk CAD digital drawings files or PDF digital files that print to scale.

The Contractor shall prepare and furnish to the Engineer, in duplicate, prints showing in detail all plant and equipment which he intends to use at the construction site.

The Contractor shall furnish catalog cuts where specifically required by the Specifications, and for other items where the Engineer may deem them necessary. Nine (9) copies of catalog cuts shall be submitted for approval and the Engineer shall return five (5) copies to the Contractor within fourteen (14) calendar days indicating appropriate action.

Approval of drawings or catalog cuts which are inconsistent with the requirements of the Contract Drawings and Specifications shall not be deemed to waive or change such requirements or to relieve the Contractor of his obligation to perform such requirements, unless the Engineer shall expressly and specifically state that he is waiving or changing such requirements.

The Contractor shall fill in the dates on which he will furnish such working drawings and catalog cuts in a schedule furnished by the Contractor to the Owner. The completed schedule shall be delivered to the Engineer for his approval within ten (10) days after execution of the Contract.

All drawings, data, and other papers of any type whatsoever, whether in the form of writing, figures or delineations, which are prepared in connection with this Contract and submitted to the Owner shall become the property of the Owner. Except to the extent that rights are reserved to others under valid patents for which the Owner is not given a license under the provisions of the Article entitled "ROYALTIES, PATENTED DEVICES, MATERIALS, AND PROCESSES", the Owner shall have the non-exclusive right to use or permit the use of all such drawings, data and other papers and any ideas or methods represented thereby for any purpose at any time without additional compensation. No such papers shall be deemed to have been given in confidence. Any statement or legend to the contrary in connection with such drawings, data or other papers and in conflict with the provisions of this paragraph shall be void and of no effect.

88. DISCREPANCIES AND OMISSIONS

Should anything which is necessary for a clear understanding of the work be omitted from the Contract Documents, or should it appear that various instructions are in conflict, the Contractor shall secure written instructions from the Engineer before proceeding with the work affected by such omissions or discrepancies.

In resolving inconsistencies among two (2) or more sections for the Contract Documents, precedence shall be given in the following order:

- | | |
|---------|--|
| First | Executed Construction Agreement |
| Second | Proposal Section |
| Third | Plans |
| Fourth | Special Provisions |
| Fifth | General Conditions |
| Sixth | NJDOT Supplemental Specifications |
| Seventh | NJDOT Specifications |
| Eighth | Cited Standards for Materials or Testing |

Figured dimensions on Plans and calculated dimensions shall take precedence over scale dimensions. Detailed Plans in the Contract Documents shall take precedence over general plans.

As the Work progresses, it is anticipated that the Contractor shall frequently apply to the Engineer relative to the interpretation and coordination of the Contract Documents. Such applications shall be in writing. Should it appear that the Work to be done or any of the matters relative thereto are not sufficiently detailed or explained in the Contract Documents, the Contractor shall apply to the Engineer for such further explanations as may be necessary and shall conform to them as part of the Contract.

Both parties realize that in performing the Work, field conditions may require modifications in the Plans and quantities of Work involved. Work under all Pay Items must be carried out to meet these field conditions to the satisfaction of the Engineer and in accordance with its directions and the Contract Documents.

The Contractor shall not take advantage of any apparent error or omission in the Contract Documents. In the event the Contractor discovers any discrepancy, error, or omission in the Plans, Specifications, or other Contract Documents, or if there is any doubt or question as to the intent or meaning of the Plans, Specifications, or other Contract Documents, the Contractor shall immediately notify the Engineer in writing. The Engineer will promptly make, in writing, such corrections and interpretations as deemed necessary.

89. VERIFICATION AND WARRANTY

The Contractor shall thoroughly examine and become familiar with all of the various parts of the Contract Documents and determine the nature and location of the work, the general and local conditions, and all other matters, which can in any way affect the work under this Contract. Failure to make an examination necessary for this determination shall not release the Contractor from the obligations of this Contract. The Contractor warrants that no verbal agreement or conversation with any officer, agent, or employee of the Owner, or Engineer, either before or after the execution of this Contract, has affected or modified any of the terms or obligations herein contained.

90. DOCUMENTS TO BE KEPT ON THE JOBSITE

The Contractor shall keep one (1) copy of the Contract Documents on the jobsite, in good order, available to the Engineer. The Contractor shall maintain on a daily basis at the jobsite, and make available to the Engineer on request, one (1) current record set of the Plans which have been accurately marked up to indicate all approved changes in the completed work that differ from the information shown on the Plans. Upon substantial completion of the work, the Contractor shall give the Engineer one (1) complete set of marked-up record Plans.

91. OWNERSHIP OF CONTRACT DOCUMENTS

The Contract Documents, and copies of parts thereof, furnished by the Engineer are the property of the Owner. They are not to be used on other work and, with the exception of the signed Contract set, are to be returned to him at his request. Any reuse of these materials without authorization by the Engineer will be at the risk of the user and without liability or legal expense to the Engineer or to the Owner. Any such authorization will entitle the Engineer to compensation at rates to be agreed upon by the user and the Engineer.

92. RESERVED**93. RESERVED****CONTROL OF MATERIAL****94. SOURCE OF SUPPLY AND QUALITY REQUIREMENTS**

Unless otherwise stipulated, the Contractor shall provide and pay for all materials, labor, utility services, tools, equipment, and all appliances, machinery, transportation, and appurtenances necessary for the execution and completion of the work and such additional items not specifically indicated or described that can be reasonably inferred as belonging to the item described or indicated and as required by good practice to provide a complete and satisfactory system or structure.

All materials for the Project shall be furnished by the Contractor and shall be new, unless otherwise specifically prescribed in the Contract Documents and both workmanship and materials shall be of good quality, and fit for the particular purpose for which used. The materials shall conform to the requirements of the Contract Documents and shall be from approved sources. Only materials which have been approved by the Engineer shall be used.

Within 12 hours after receiving a shipment of materials, the Engineer shall be notified of the kind, size, quantity, and location thereof.

In any item of construction, the sources, brands, or types of materials shall not be changed without the consent of the Engineer. Request for such changes shall be filed with the Engineer 30 days prior to shipment or 30 days prior to the date needed, whichever is earlier, of such changes as required above. The request shall state the name and address of the owner, the location of the proposed source, the method of shipment, and the intended use of the material.

The foregoing provisions shall apply with regard to requests by Subcontractors for the sources of the materials they propose to use, such requests to be submitted through the Contractor.

The notice provisions of this Article shall not be so construed as to relieve the Contractor of his obligation to ensure that all materials required for the construction of the Project shall be available at the time and place necessary for their incorporation into the Work in order that the completion

date set forth in the Information to Bidders is met. If any doubt exists as to the timely availability of any material, the Engineer shall be immediately informed, in writing, of the potential problem and of the action to be taken to guarantee the availability of such material. Stockpiles of materials whose availability is or may be problematical shall be established at an early date.

95. LOCAL MATERIAL SOURCES

Possible sources of local materials may be designated on the Plans or in the Specifications. The quality of material in such deposits may be acceptable in general, but the Contractor shall determine for itself the amount of equipment and Work required to produce a material meeting the requirements of the Contract Documents. It shall be understood that it is not feasible to ascertain from samples the limits or quantity for an entire deposit, and that variations shall be considered as usual and are to be expected. The Engineer may order procurement of material from any portion of a deposit and may reject portions of the deposit as unacceptable.

The Owner may acquire, and make available to the Contractor, the right to take materials from the sources designated on the Plans or described in the Specifications, together with the right to use such property as may be specified, for plant site, stockpiles, and hauling roads.

If the Contractor desires to use material from sources other than those designated, the Contractor shall acquire the necessary rights to take materials from the sources and shall pay all costs related thereto, including any which may result from an increase in length of haul. All costs of exploring and developing such other sources shall be borne by the Contractor. The use of material from other than designated sources is not permitted until such preliminary samples as may be required by the Engineer have been obtained and tested at the expense of the Contractor. Additional samples may be required of the Contractor for inspection and testing by the Engineer prior to approval of and authorization to use the source.

When material sources are not described in the Specifications or where those designated provide insufficient material, the Contractor shall provide sources of acceptable material. When these sources are provided by the Contractor, the Owner assumes the cost of processing samples to determine the suitability of the material except as in GENERAL CONDITIONS Article "MATERIALS, INSPECTIONS, TESTS, AND SAMPLES".

Unless otherwise permitted, borrow pits and quarries occupied by the Contractor, or his Subcontractor, or suppliers exclusively for the Project shall be so excavated that water does not collect and stand therein. Sites from which material has been removed shall be left in a neat and presentable condition before Completion. Where practicable, all pits and quarry sites shall be located so that they are not visible from the highway.

96. SUBMITTALS

Submittal requirements for shop drawings and other items to be submitted by the Contractor are, if applicable, set forth in GENERAL CONDITIONS Article "SUPPLEMENTING DRAWINGS, INSTRUCTIONS, WORKING DRAWINGS AND CATALOG CUTS" and the Specifications and/or Technical Provision.

97. RELEASE OF BITUMINOUS AND CEMENT CONCRETE

Material will be released from the plant when the Inspector notifies the plant that conditions at the job site are acceptable for incorporation of the material into the work. The Engineer shall be notified at least 24 hours in advance of any anticipated releases.

98. MATERIALS, INSPECTIONS, TESTS, AND SAMPLES

The Contractor shall furnish, without extra charge, the necessary test pieces and samples, including facilities and labor for obtaining the same, as requested by the Engineer. When required, the Contractor shall furnish certificates of tests of materials and equipment made at the point of manufacture by a recognized testing laboratory approved by the Engineer. All materials will be inspected, tested, and approved before incorporation in the Work. Unapproved materials may be used only with written permission of the Engineer. In the absence of such written permission, unapproved materials will not be paid for and shall be removed at no cost to the Owner.

All materials being used are subject to inspection, testing, or rejection at any time prior to Acceptance.

Samples will be taken by a representative of the Contractor in the presence of the Engineer. Results of tests, made with the Contractor's laboratory apparatus and conforming to the requirements specified in the prescribed methods of tests will be furnished to the Engineer. Testing will be performed in accordance with AASHTO or ASTM methods of tests or in accordance with specified New Jersey Department of Transportation test methods.

Nothing in this Article shall be construed to limit the right of the Engineer to order special inspection or tests as provided in GENERAL CONDITIONS Article "SPECIAL INSPECTION, TESTING, OR APPROVAL". If the Specifications, the Engineer's instructions, laws, or any public Owner require any work to be specially tested or approved, the Contractor shall give timely notice of his readiness for testing or inspection. Inspections to be conducted by the Engineer will be promptly made, and where practicable, at the source of supply.

The required number of samples and rate of sampling, or Certifications of Compliance for the various materials are as specified in the respective methods of test or in the Articles applicable to that particular material or Pay Item. Additional samples shall be required whenever, in the opinion of the Engineer, additional tests are required to determine the quality and suitability of materials for their respective uses.

The sampling and field testing of soil aggregates shall conform to the general requirements for sampling and testing specified in the Articles applicable to that particular material/Pay Item or the New Jersey Department of Transportation's Standard Specification Section 901, and with the following requirements, provided, however, that the following requirements shall govern where there is any conflict or inconsistency between them.

The Contractor shall determine initially, by means of proper sampling and laboratory tests that soil aggregate materials from proposed sources conform to the requirements of the Specifications. Written notice of the proposed sources of soil aggregate materials, as well as the results of the sampling and testing, shall be given to the Engineer by the Contractor after the initial determination as specified above, and not less than ten (10) days prior to the time of their intended use. The Engineer may request the Contractor to sample and test materials representative of that portion of the source intended to be used.

Approval by the Engineer of a proposed source of any aggregate materials does not constitute approval of materials delivered to the site of the Work from that source, but shall be deemed as permission to select and use materials from that source only so long as they conform to the Specifications. The Contractor shall progressively determine for itself by proper sampling and laboratory tests, while the sources are in use, that materials selected from approved sources conform to the Specifications. Should the source contain oversize material, the Engineer may require the Contractor to eliminate such oversize material.

The final and governing determination of conformance or nonconformance with the Contract Documents will be made based on sampling and testing of the materials after they have been placed in accordance with the Contract Documents. All materials in place in the Work which do not conform to the Contract Documents shall be removed and replaced with materials which do conform thereto, or their deficiencies shall be corrected. For those materials subject to density testing, conformance shall include compliance with the density requirement. After the initial corrective action has been taken, the Contractor will take an additional sample, and if necessary, one (1) check sample. If the materials still do not conform to the requirements of the Contract Documents after additional corrective action, the Contractor shall supply the Engineer with a gradation of the in-place material showing the size of sample, all calculations, final gradation, name of person performing the test, date, and location of sample taken. Further testing will not be performed by the Contractor until the Contractor certifies that the rejected material has been corrected. After this certification, the Engineer will analyze one (1) additional sample supplied by the Contractor, and if this sample does not meet the Contract Documents, the material shall be removed.

The Contractor shall excavate test pits and provide such facilities as the Engineer may require in order to properly sample the source and shall, if the source is approved, remove any overburden which would contaminate the material intended for use on the Project. If soil aggregate materials are obtained by dredging, the Contractor shall provide safe and adequate water transportation for the Engineer to and from the dredges or other boats and shall cooperate with the Engineer in every reasonable way to expedite inspection and sampling of the materials. The cost of such work, facilities, and transportation, in connection with sampling by the Engineer at the proposed source of soil aggregate materials, and the initial and progressive sampling and testing of materials at their sources, performed by the Contractor, shall be included in the prices bid for the various Pay Items scheduled in the Proposal as well as the sampling and testing of aggregates which meet the Specifications and are used in the Work.

The cost of sampling and testing by the Contractor of soil aggregates which do not conform to the Specifications for gradation and density and the cost of sampling and testing of soil aggregates which do conform to the Specifications but are not used in the Work shall be paid by the Contractor.

99. PERFORMANCE TESTING

Operating equipment and systems shall be performance tested in the presence of the Engineer to demonstrate compliance with the Specifications. Performance testing shall be conducted under the specified design operating conditions or under such simulated operating conditions as recommended or approved by the Engineer. Such testing shall be scheduled with the Engineer at least one (1) week in advance of the planned date of testing. Detailed test requirements are set forth in the Specifications.

100. CERTIFICATION OF COMPLIANCE

Materials or assemblies, as specified, will be accepted on the basis of Certificates of Compliance stating that such materials or assemblies fully comply with the requirements of the Contract. The form of Certificates of Compliance must be approved by the Engineer.

Materials or assemblies, used on the basis of Certificates of Compliance, may be sampled and tested at any time. If found not to be in conformance with the Contract requirements, materials and assemblies will be rejected whether in place or not. The Contractor shall require the manufacturer or supplier to furnish four (4) copies of Certificates of Compliance with each delivery of materials, components, and manufactured items that are acceptable by certification. The Engineer will be provided with three (3) copies and one (1) copy shall be retained by the Contractor.

Certificates of Compliance are to contain the following information:

- A. Project to which the material is consigned.
- B. Name of the Contractor to which the material is supplied.
- C. Kind of material supplied.
- D. Quantity of material represented by the certificate.
- E. Means of identifying the consignment, such as label marking, seal number, etc.
- F. Date and method of shipment.
- G. Statement that the material has been tested and found in conformity with the pertinent Contract requirements stated in the certificate.
- H. Signature of a person having legal Owner to bind the supplier.
- I. Signature attested to by a notary public or other properly authorized person.

Payments will not be made for materials specified to be accepted on the basis of Certificates of Compliance until the Engineer has received the required Certificate of Compliance.

101. PLANT INSPECTION

The Engineer may undertake the inspection of materials at the source. Manufacturing plants may be inspected periodically for compliance with specified manufacturing methods. Material samples may be obtained for laboratory testing for compliance with materials quality requirements. Plant inspection may be the basis for the acceptability of manufactured lots as to quality.

In the event plant inspection is undertaken, the following conditions shall be met:

- A. The Engineer will have the cooperation and assistance of the Contractor and the producer with whom the Contractor contracted for materials.
- B. The Engineer will have full entry at all times to such parts of the plant as may concern the manufacture or production of the materials being furnished.
- C. If required by the Engineer, the Contractor shall arrange for approved office space for the use of the inspector. Such space shall be located conveniently in or near the plant.
- D. Adequate safety measures shall be provided and maintained. It is understood that the Owner reserves the right to retest all materials that have been tested and accepted at the source of supply after the same have been delivered and to reject all materials which, when retested, do not meet the requirements of the Contract Documents.

102. CONTRACTORS' AND MANUFACTURERS' COMPLIANCE WITH STATE SAFETY, OSHA, AND OTHER CODE REQUIREMENTS

The completed Work shall include all necessary permanent safety devices, such as machinery guards and similar ordinary safety items required by laws. Further, any features of the work (including Owner-selected equipment) subject to such safety regulations shall be fabricated, furnished, and installed in compliance with these requirements. The Contract shall include the provisions of this Article in his agreements with Subcontractors, suppliers, and manufacturers of equipment.

In selecting and/or accepting equipment for installation in the project, the Owner and Engineer assume no responsibility for any personal injury, property damage, or any other damages or claims resulting from failure of the equipment to comply with applicable safety codes or requirements, or the safety requirements of a recognized agency, or failure due to manufacturer's faulty design concepts, or defective workmanship and materials. The Contractor shall indemnify and hold the

Owner and Engineer harmless against any and all liability, claims, suits, damages, costs or expenses without limitation arising out of the installation or use of such equipment.

103. STORAGE AND HANDLING OF MATERIALS

Materials shall be stored to ensure the preservation of their quality and fitness. Stored materials, even though approved before storage, may again be inspected prior to their use on the Project. Stored materials shall be located so as to facilitate their prompt inspection. With the approval of the Engineer, portions of the right-of-way may be used for storage purposes and for the placing of the Contractor's plant and equipment, but any additional space must be provided by the Contractor at the Contractor's expense. Materials to be stored on Port property shall not create an obstruction to air navigation nor shall they interfere with the free and unobstructed movement of aircraft. Unless otherwise shown on the plans, the storage of materials and the location of the Contractor's plant and parked equipment or vehicles shall be as directed by the Engineer. No materials shall be stored within 4 yards, plus the extended boom length of the largest crane on site, of overhead high voltage power lines. The high voltage power line is defined as an aerial power line having a voltage differential in excess of 750 volts between any pairs of conductors or between any conductor and ground. The Contractor shall be responsible for any power outage or de-energization associated with the Contractor's activity in the vicinity of the power lines. Private property shall not be used for storage purposes without written permission of the owner or lessee. Copies of such written permission shall be furnished to the Engineer prior to storage. Storage sites shall be restored to their original condition at no cost to the Owner.

Materials shall be handled to ensure the preservation of their quality and fitness. Aggregates shall be transported from the storage site to the Project site in tight vehicles constructed to prevent loss or segregation of materials after loading and measuring in order that there shall be no inconsistencies in the quantities of materials intended for incorporation in the Project as loaded, and the quantities actually received at the place of operations.

104. UNACCEPTABLE MATERIALS

All materials, whether in place or not, which do not conform to the requirements of the Contract Documents shall be considered as unacceptable, and such materials will be rejected and shall be removed immediately from the site of the Work unless otherwise directed. Rejected material, the defects of which have been corrected, shall not be used until approval has been given.

105. OWNER FURNISHED MATERIAL

The Contractor shall furnish all materials required to complete the Work, except those specified to be furnished by the Owner. Material furnished by the Owner will be delivered or made available at the points specified in the Specifications.

The cost of handling and placing the materials after they are delivered or made available shall be considered as included in the Work for the Pay Item in connection with which they are used.

The Contractor is to be responsible for all material delivered to it, and deductions will be made from any monies due or that may become due the Contractor to make good any shortages and deficiencies, from any cause whatsoever, and for any damage which may occur after such delivery, and for any demurrage charges.

106. SUBSTITUTES OR "OR EQUAL" ITEMS

Whenever materials or equipment are specified or described in the Contract Documents by using the name of a proprietary item or the name of a particular supplier, the naming of the item is

intended to establish the type, function, and quality required. Unless the name is followed by words indicating that no substitution is permitted, materials or equipment of other suppliers may be accepted if sufficient information is submitted by the Contractor to allow the Engineer to determine that the material or equipment proposed is equivalent or equal to that named. Requests for review of substitute items of material or equipment will not be accepted from anyone other than the Contractor. If the Contractor wishes to furnish or use a substitute item of material or equipment, the Contractor shall make written application to the Engineer for approval thereof, certifying that the proposed substitute performs adequately the functions and achieves the results called for by the general design, is similar and of equal substance to that specified, and is suited to the same use as that specified. The application shall state that the evaluation and approval of the proposed substitute does not prejudice the Contractor's achievement of Completion on time. It shall also state whether or not approval of the proposed substitute for use in the Work requires a change in any of the Contract Documents (or in the provisions of any other direct Contract with the Owner for Work on the Project) to adapt the design to the proposed substitute, and whether or not incorporation or use of the substitute in connection with the Work is subject to payment of any license fee or royalty. All variations of the proposed substitute from that specified shall be identified in the application, and available maintenance, repair, and replacement service shall be indicated. The application shall also contain an itemized estimate of all costs that result directly or indirectly from approval of such substitute, including costs of redesign, all of which will be considered in evaluating the proposed substitute. The Engineer may require the Contractor to furnish additional data about the proposed substitute.

If a specific means, method, technique, sequence, or procedure of construction is indicated in or required by the Contract Documents, the Contractor may furnish or use a substitute means, method, technique, sequence, or procedure of construction which is acceptable, if the Contractor submits sufficient information to allow the Engineer to determine that the substitute proposed is equivalent to that indicated or required by the Contract Documents. The procedure for review by the Engineer is to be similar to that described in the previous paragraph.

The Engineer is to be allowed a reasonable time within which to evaluate each proposed substitute. The Engineer will be the sole judge of acceptability, and no substitute shall be ordered, installed, or used without either a Construction Order or an approved working drawing. If approval is given, it is on the condition that the Contractor is fully responsible for producing Work in conformity with Contract requirements. If, after trial use of the substituted materials, equipment, means, method, technique, sequence, or procedure of construction, the Engineer determines that the Work produced does not meet Contract requirements, the Contractor shall discontinue the use of the substitute and shall complete the remaining Work with the specified materials, equipment, means, method, technique, sequence, or procedure of construction. The Contractor shall remove the deficient Work and replace it as specified, or take such other corrective action as the Engineer may direct. Changes will not be made in the basis of payment for the Pay Items involved, nor in the Contract Time as a result of authorized substitutes. The Engineer may require the Contractor to furnish at no cost to the Owner a special performance guarantee or other surety with respect to any substitute. The Engineer will document the time required by the Owner in evaluating proposed substitutions and in making changes in the Contract Documents.

If the Engineer shall disallow the requested substitute, for just cause, the Contractor shall abide by the Engineer's decision. The Contractor shall have no claim of economic impact due to his reliance upon the substitute price as a basis for his bid. The Owner makes no guarantee of substitute approval by the Engineer and, therefore, will not entertain a claim for additional compensation due to rejection of any substitution request.

When the Contract Documents permit the use of more than one type of material, equipment, or product, only one type is to be used throughout the Project.

107. GUARANTEE

Unless specifically stated otherwise in the Contract Documents, all work provided under this contract by the Contractor or any of his Subcontractors shall be warranted to the Owner as follows:

All work shall be fit for the particular purpose for which used, and be guaranteed by the Contractor against all defects in workmanship and material for a period of one (1) year following contract completion or, if specifically called for in these Contract Documents and enumerated in the SUPPLEMENTAL CONDITIONS, for a period of one (1) year following the date of Substantial Completion as established by the Engineer for specified items of equipment or other designate parts of the work, as enumerated in each Certificate of Substantial Completion issued by the Engineer.

The Contractor shall make, at his own expense, all repairs and/or replacements necessitated by defects in materials or workmanship in work provided by him or any of his Subcontractors that become evident within the guarantee period.

The Contractor also agrees to hold the Owner and Engineer harmless from liability of any kind arising from damage due to said defects. The Contractor shall make all repairs and replacements promptly upon receipt of written orders for same from the Owner. If within ten (10) days (or such longer period as the Owner may allow) after the Owner has notified the Contractor of a defect, the Contractor has not started to make the necessary corrections, the Owner is hereby authorized to make the corrections or to order the work to be done by a third party, and the cost of the corrections shall be paid by the Contractor.

Repetitive malfunction of equipment shall be cause for equipment replacement and an extension of the guarantee period to a date one (1) year following acceptable replacement.

The Owner's rights under this Article shall be in addition to, and not a limitation of, any other rights and remedies available at law or in equity.

108. CORRECTION OF DEFECTIVE WORK AFTER CONTRACT COMPLETION

The Contractor hereby agrees to make, at his own expense, all repairs and replacements necessitated by defects in materials or workmanship in work provided by him or any of his Subcontractors, equipment manufacturers and suppliers, and pay for any damage to other works resulting from such defects, which become evidence within one (1) year after Contract Completion or within one (1) year after the date of Substantial Completion established by the Engineer for specified items of equipment, or within such longer period of time as may be prescribed by law or by the terms of any applicable special guarantee required by the Contract Documents.

The Contractor also agrees to hold the Owner and the Engineer harmless from liability of any kind arising from damage due to said defects. The Contractor shall make all repairs and replacements in the time specified in Article "OWNER'S RIGHT TO CORRECT DEFECTIVE WORK" of these GENERAL CONDITIONS upon receipt of written order for same from the Owner. If the Contractor fails to make the repairs and replacements promptly, the Owner may do the work and the Contractor and his Surety shall be liable for the cost thereof.

109. RESERVED

110. RESERVED

LEGAL RELATIONS AND RESPONSIBILITY TO PUBLIC

111. GOVERNING LAW

The terms and conditions of this Contract shall be construed and interpreted under, and all respective rights and duties shall be governed by, the laws of the State of New Jersey, to the extent not superseded by federal law. The Contractor's attention is called to the Federal Requirements provisions contained in the "Instructions to Bidders" portion of the bidding requirements comprising a portion of the Contract Documents.

Whenever applicable each provision of these Contract Documents shall be interpreted in such a manner as to be effective and valid under applicable law, but if any provision of these Contract Documents shall be prohibited by or invalid under applicable law, such provision shall be ineffective to the extent of such prohibition or invalidity, without invalidating the remainder of such provision or the remaining provisions of these Contract documents.

112. APPLICABLE LAWS

The Contractor shall keep fully informed of all Federal, State, and local laws, ordinances, and regulations, and all orders and decrees of bodies or tribunals having any jurisdiction or Owner, which in any manner affect those engaged or employed on the Work, or which in any way affect the conduct of the Work. The Contractor shall at all times observe and comply with, and shall cause its agents and employees to observe and comply with, all such laws, ordinances, regulations, orders, and decrees and shall protect and indemnify the Owner, Engineer, and their officers, employees, agent, and representatives against any claim or liability arising from or based on the violation of any such law, ordinance, regulation, order, or decree, whether by the Contractor or the Contractor's agents or employees, Subcontractors of any tier, suppliers, or materialmen. If any discrepancy or inconsistency is discovered between the Contract Documents and any such law, ordinance, regulation, order, or decree, the Contractor shall immediately report the same to the Engineer in writing.

113. PERMITS AND LICENSES

The Contractor shall procure all permits, grants, and licenses, pay all charges, fees, and taxes, and give all notices necessary and incidental to the due and lawful prosecution of the Work except where the Owner has procured such permits, grants, or licenses for temporary or permanent construction. The Contractor shall advise the issuing agency or party of its proposed operations and obtain their cooperation and such supplemental permission as may be necessary. Before submitting his bid, the Contractor should obtain from the Owner all available information on the permits, grants, and licenses the Owner has obtained. Charges incurred by the Contractor for permits, grants, and licenses in connection with the Work shall be paid by the Contractor and shall be included in the prices bid for the various Pay Items scheduled in the Proposal.

Before the Contractor performs dredging or channel excavation within tidal waterways for the procurement of materials, or performs therein other work of his own, when such work is not part of the permanent or temporary Work provided for in the Contract, the Contractor shall advise USACE, USCG, and NJDEP, Division of Marine Services and Division of Water Quality of its intended work. If the waterway is not navigable, the Contractor shall notify the Division of Water Quality only. The Contractor shall procure all necessary permits for such work from the above named agencies

having jurisdiction and interest and shall comply with their rules and regulations in the performance of the above mentioned work.

The Department of the Army, acting through the Corps of Engineers, is charged with the responsibility for the administration of laws for the protection and preservation of navigation and the navigable waters of the United States. Section 10 (33 USC 403) of the River and Harbor Act of 3 March 1899 specified that: "The creation of any obstruction not affirmatively authorized by Congress, to the navigable capacity of any of the waters of the United States is prohibited; and it shall not be lawful to build or commence the building of any wharf, pier, dolphin, boom, weir, breakwater, bulkhead, jetty, or other structures in any port, roadstead, haven, harbor, canal, navigable river, or other water of the United States, outside established harbor lines, or where no harbor lines have been established, except on plans recommended by the Chief of Engineers and authorized by the Secretary of the Army; and it shall not be lawful to excavate or fill, or in any manner to alter or modify the course, location, condition, or capacity of, any port, roadstead, haven, harbor, canal, lake, harbor of refuge, or enclosure within the limits of any breakwater, or of the channel of any navigable water of the United States, unless the work has been recommended by the Chief of Engineers and authorized by the Secretary of the Army prior to beginning the same" (30 Stat 1151; 33 USC 403). Failure to obtain a Department of Army Permit is a violation of Section 10 cited above, and penalties therefor may be adjudged. In addition, the owners of such non-authorized structures are considered legally responsible and liable for damages attributable thereto or occasioned thereby.

A pamphlet describing the procedures for applying for a permit together with a list of applicable waterways may be obtained free of charge from the various district offices of the Corps of Engineers.

Section 21 PL 91-224, The Water Quality Improvement Act 1970, requires a certification in connection with any permit application to conduct any activity, including but not limited to the construction or operation of facilities which may result in any discharge into the navigable waters of the United States. This certification must be made by the State or interstate agency responsible for water quality or by the Secretary of the Interior as the case may be to the effect that there is reasonable assurance that the permitted activity will not violate water quality standards.

Upon receipt of any application for such permit, a public notice is issued to all known interested parties and to the news media to provide an opportunity for individuals and Federal, State, and local governmental agencies to comment on the proposed work being considered. In known controversial cases, a public hearing will be held in order that all views may be presented for consideration. The period normally allowed for receipt of comments is 30 days. If the proposed work is not considered to adversely affect navigation, fish and wildlife, water quality, conservation, aesthetics, recreation, ecology, and other aspects of the public interest, and if no objections are received, the Department of the Army Permit is then issued. If objections to the proposed work are received, an attempt is made to resolve the differences between the objector and the applicant. If this attempt is unsuccessful, the application, objections, and all pertinent information, including the minutes of the public hearing if held, with the District Engineer's recommendations, are forwarded to the office of the Chief of Engineers for an ultimate decision, all of which requires additional time for final action.

Prior to submitting a bid based on utilizing hydraulically procured soil aggregate materials, Bidders shall assure themselves that the NJDEP will issue a permit to dredge such materials.

114. RESTORATION OF SURFACES OPENED BY PERMIT

The right to construct or reconstruct, or maintain any public or private utility service, FAA or NOAA facility or a utility service of another government agency in the highway, street or Port Facility, or to

grant permits for same, at any time, is hereby expressly reserved by the Owner for the public utilities and proper authorities of the municipality in which the Work is done, and the Contractor shall not be entitled to any damages either for the digging up of the street or for any delay occasioned thereby.

When an individual, firm, or corporation is authorized through a duly executed permit from the Owner, the Contractor shall allow parties bearing such permits, and only those parties, to make openings in the highway. When ordered by the Engineer, the Contractor shall make all necessary repairs due to such openings, and such necessary work will be paid for as Extra Work or as specifically provided elsewhere in the Contract Documents.

115. FEDERAL AID PARTICIPATION

For Federally funded contracts, the United States Government has agreed to reimburse the Owner for some portion of the contract costs. Such reimbursement is made from time to time upon the Owner's (sponsor's) request to the granting agency. In consideration of the United States Government's agreement with the Owner, the Owner has included provisions in this contract pursuant to the requirements of the Rules and Regulations of the grant that pertain to the work.

As required by the Act, the contract work is subject to the inspection and approval of duly authorized representatives of the Federal government, and is further subject to those provisions of the rules and regulations that are cited in the contract, plans, or specifications.

No requirement of the Act, the rules and regulations implementing the Act, or this contract shall be construed as making the Federal Government a party to the contract nor will any such requirement interfere, in any way, with the rights of either party to the contract.

116. ENVIRONMENTAL PROTECTION

The Contractor shall comply with all applicable Federal, State, and local laws and regulations, and all conditions of permits controlling pollution of the environment. Necessary precautions shall be taken to prevent pollution of streams, lakes, ponds, wetlands, groundwater, and reservoirs with fuels, oils, bitumens, chemicals, or other harmful materials and to prevent pollution of the atmosphere from particulate and gaseous matter.

All modifications to permits that are proposed by the Contractor shall be submitted to the Owner for approval prior to submitting them to the regulatory agencies having jurisdiction and interest. After receiving the Owner's approval, the Contractor shall obtain all other necessary approvals from the appropriate regulatory agencies. Any time required to obtain the approvals will not warrant extensions of contract time. The Contractor shall perform the Work in compliance with the terms and conditions of all permits procured for the Project. If the Contractor is not in compliance with permit provisions, corrective actions shall be taken immediately. The Engineer may suspend the Work, wholly or in part, in accordance with GENERAL CONDITIONS Article "TEMPORARY SUSPENSION OF WORK," until such time as the Contractor is fully in compliance with all permits. All corrective and remedial work required to bring the Contractor into compliance shall be performed at no cost to the Owner.

The Contractor shall pay all fees and violation charges that arise out of or are alleged to arise out of its noncompliance or the noncompliance of its agents, employees, and Subcontractors with permit requirements. In its sole discretion, the Owner may determine to hold the Contractor responsible for all engineering, inspection, and administration costs (including overhead) incurred as a result of its noncompliance. If it so determines, the Owner will deduct the amount of such costs from the monthly estimate and payment due in accordance with GENERAL CONDITIONS Article "PARTIAL PAYMENTS."

The Contractor shall provide to the Engineer, whenever requested, all documentation pertaining to the noncompliance and related corrective actions taken.

The Contractor shall also comply with the following:

- A. Control of Soil Erosion and Water Pollution - The Contractor shall employ soil erosion and sediment control measures during the life of the Project to control erosion and minimize the sedimentation of rivers, streams, lakes, reservoirs, wetlands, floodplains, bays, and coastal waters in accordance with the current version of the "Standards for Soil Erosion and Sediment Control in New Jersey."

The Contractor is responsible to provide the Engineer with documentation that a soil erosion and sediment control plan has been approved by the appropriate soil conservation district for off-Project borrow pits or storage areas that the Contractor uses or establishes to accomplish the Work of the Project.

- B. Control of Noise and Air Pollution - The Contractor shall employ all possible methods to minimize noise and dust pollution caused by drilling, blasting, excavation, and hauling operations. These shall include, but shall not necessarily be limited to, use of dust collection devices or water injectors on drilling units.

All construction equipment powered by an internal combustion engine shall be equipped with a properly maintained muffler. Air-powered equipment shall be fitted with pneumatic exhaust silencers. Air compressors shall meet EPA noise emission standards.

Stationary equipment powered by an internal combustion engine shall not be operated within 50 yards of noise sensitive sites without portable noise barriers placed between the equipment and the noise sensitive sites. Noise sensitive sites include residential buildings, motels, hotels, schools, churches, hospitals, nursing homes, libraries, and public recreation areas. Portable noise barriers shall be constructed of plywood or tongue and groove boards with a noise absorbent treatment on the interior surface (facing the equipment).

All methods and devices employed to minimize noise and dust pollution are subject to the daily approval of the Engineer.

- C. Historic Places - The Contractor will not be permitted to use as a disposal site or obtain borrow excavation from locations eligible for or listed on the State or National Registers of Historic Places. Copies of the State and National Registers of Historic Places are available from the New Jersey Department of Transportation's Bureau of Environmental Services.
- D. Disposal Sites Beyond Project Limits - Material shall not be disposed of beyond the Project limits until the Engineer has approved the location of the disposal site and received a copy of the soil and sediment control plan certified by the soil conservation district in accordance with NJSA 4:24-39 *et seq.*
- E. Borrow Pits - Material shall not be excavated from a borrow pit beyond the Project's limits until the Engineer has received a copy of the soil and sediment control plan certified by the soil conservation district in accordance with NJSA 4:24-39 *et seq.*

117. ARCHAEOLOGICAL AND HISTORICAL FINDINGS

Unless otherwise specified in this Article, the Contractor is advised that the site of the work is not within any property, district, or site, and does not contain any building, structure, or object listed in the current National Register of Historic Places published by the United States Department of Interior.

When excavating operations encounter prehistoric remains or artifacts of historical or archaeological significance, the operations shall be temporarily discontinued in that area and the Engineer shall immediately be notified. The Engineer will consult archaeological authorities and determine the disposition of the remains or artifacts.

The Contractor agrees to make no claim for additional payment or for an extension of Contract Time because of any delays in the progress or alteration of the prosecution of the Work due to such discontinuance of the work or removal of any such remains or artifacts for the first ten (10) days of such delay. Thereafter and beginning on the eleventh (11th) day, compensation for such delay and an extension of Contract Time will be considered in accordance with the provisions of GENERAL CONDITIONS Article "SUSPENSION OF WORK".

118. TAXES AND CHARGES

The Contractor shall withhold and pay all withholding taxes, whether State or Federal, and pay all Social Security taxes and also all State Unemployment Compensation taxes for his employees, and pay or cause to be withheld, as the case may be, any and all taxes, charges, or fees or sums whatsoever, which are now or may hereafter be required to be paid or withheld under any laws.

Pursuant to L. 1966, c. 30, §9, as amended (C.54:32B-9), the Owner is not subject to the sales and use taxes imposed under New Jersey's Sales and Use Tax Act. A Certificate to this effect can be obtained from the Owner. NJSA 54:32B-9 provides that any sale or service to the State of New Jersey, or any of its agencies, instrumentalities, public authorities, public corporations (including a public corporation created pursuant to agreement or compact with another State), or political subdivisions where the State is the purchaser, user, or consumer, is not subject to the sales and use taxes imposed under the Sales and Use Tax Act. NJSA 54:32B-8 provides that sales of materials, supplies, or services made to Contractors, Subcontractors, or repairmen for exclusive use in erecting structures, or building on, or otherwise improving, altering, or repairing real property of the above listed bodies are exempt from the tax on retail sales imposed by the Sales and Use Tax Act. The sales tax exemption does not apply for equipment used for Contract work or for force account work whether the equipment is to be purchased or rented. The exemption provided under NJSA 54:32B-8 is conditioned on the person seeking such exemption qualifying therefor pursuant to the rules and regulations and upon the forms prescribed by the New Jersey Division of Taxation. The required form, "Contractor's Exemption Purchase Certificate" (Form No. ST-13), can be obtained by writing or calling the New Jersey Division of Taxation, Tax Information Services (TIS), CN 269, Trenton, New Jersey 08625, or any New Jersey Division of Taxation Regional Office.

119. COMPLIANCE WITH LABOR STANDARDS AND RATE OF WAGE REQUIREMENTS

The requirements of the State of New Jersey relative to the payment of prevailing wages and, if this Contract is Federally funded, the Federal requirements for compliance with the wage determination of the U.S. Secretary of Labor, shall apply. In case of discrepancies between the two (2) lists of wage rates, the Contractor shall pay not less than the higher rate for the respective crafts. The minimum prevailing wage rates, current as of the date of assembly of these Documents are available from the State of New Jersey and, if applicable, from the U.S. Secretary of Labor.

There is no guarantee that labor can be obtained at these wages, or that the Federal and State minimum wage rates will remain the same for any specified period. Unless specific agreement is made otherwise, Contractors will not be allowed additional compensation under this Contract for any wage escalation that may become effective.

120. ROYALTIES, PATENTED DEVICES, MATERIALS, AND PROCESSES

The Contractor shall pay all royalty and license fees unless otherwise specified. The Contractor shall indemnify and hold harmless the Owner and the Engineer against any and all liability, claims, royalties, suits, damages, costs or expenses, without limitation arising out of any alleged use of patented or unpatented processes, products, materials or appliances used in the performance of this Contract.

If any design, device, material, or process covered by letters of patent or copyright is used in the Work, the Contractor shall provide for such use by suitable legal agreement with the patentee or owner. The Contractor shall assume all costs arising from the use of patented materials, equipment, devices, or processes used on or incorporated in the Work. The Contractor shall defend, indemnify, and save harmless the Owner, any affected third party, or political subdivision from any and all claims for infringement by reason of the use of any such patented design, device, material, or process, or any trademark or copyright, and shall indemnify the Owner for any costs, expenses, and damages which it may be obliged to pay by reason of an infringement, at any time during the performance of the Work or after Acceptance.

121. SANITARY, HEALTH, AND SAFETY PROVISIONS

The Contractor shall provide and maintain in a neat, sanitary condition such accommodations for the use of its employees and for Owner field offices as may be necessary to comply with the requirements of the State and local health departments, or of other bodies or tribunals having jurisdiction.

The Contractor shall ensure privacy to all employees and Owner personnel assigned to the Project by providing on site separate toilet facilities for male and female employees. These facilities shall be portable toilets and clearly marked MEN and WOMEN. They are in addition to the facilities provided in the field office.

The total number of facilities shall be determined by the chart listed below. A facility is defined as one (1) unit. A facility site is defined as a location that provides at least one (1) facility for each sex. The maximum distance between the location of facility sites and workers shall be no more than half a mile.

All toilet facilities shall be in compliance with OSHA Regulation 1926.51(c) with the exception that the Owner will require that separate toilet facilities be provided for males and females. The sewage disposal method shall not endanger the health of employees and shall be in compliance with all State and Federal regulations.

Toilet facilities shall be cleaned and sanitized a minimum of once per week except from May 15 through September 15 in which these facilities shall be cleaned and sanitized a minimum of twice per week.

Number of Male Employees	Minimum No. of Facilities for Male Use	Number Of Female Employees	Minimum No. of Facilities for Female Use
1 - 15	1	1 - 15	1
16 - 35	2	16 - 35	2
36 - 55	3	36 - 55	3
56 - 80	4	56 - 80	4
81 - 110	5	81 - 110	5
111 - 150	6	111 - 150	6
Over 150	6+(1)	Over 150	6+(1)

(1) - One (1) additional facility for each additional 40 employees or part thereof of each sex.

The Contractor shall observe all rules and regulations of the Federal, State, and local health officials. Attention is directed to Federal, State, and local laws, rules, and regulations concerning construction safety and health standards. The Contractor shall not require any worker to work in surroundings or under conditions that are unsanitary, hazardous, or dangerous to the worker's health or safety.

The Contractor shall admit, without delay and without the presentation of an inspection warrant, any inspector of OSHA or other legally responsible agency involved in safety and health administration upon presentation of proper credentials.

The Contractor shall make available to the Contractor's employees, Subcontractors, the Engineer, and the public, all information pursuant to OSHA 29 CFR Part 1926.59 of The Hazard Communication Standard 29 CFR 1910.1200, and shall also maintain a file on each job site containing all Material Safety Data Sheets (MSDS) for products in use at the Project. These Material Safety Data Sheets shall be made available to the Engineer upon request.

122. PUBLIC CONVENIENCE AND SAFETY

The Contractor shall at all times so conduct the Work as to ensure the least possible obstruction to traffic. The safety and convenience of the general public and the residents along the highway or Port facility and the protection of persons and property shall be provided for by the Contractor in accordance with the contract documents.

Precaution shall be exercised at all times for the protection of persons and property. The safety provisions of applicable laws, OSHA regulations, building and construction codes, and the rules and regulations of the New Jersey Department of Labor shall be observed.

The Contractor shall maintain the free and unobstructed movement of aircraft, pedestrian and vehicular traffic with respect to his own operations and those of his Subcontractors and all suppliers in accordance with the Article titled "MAINTENANCE OF TRAFFIC" and shall limit such operations for the convenience and safety of the traveling public as specified in the Article titled "LIMITATION OF OPERATIONS".

123. RAILWAY HIGHWAY PROVISIONS

If the Contract Documents require that materials be hauled across the tracks of any railway, the Owner will arrange with the railway for any new crossings required or for the use of any existing crossings. If the Contractor elects to use crossings other than those designated, it shall make arrangements for the use of such crossings. Construction work performed on or near railroad right-

of-way shall be performed in accordance with GENERAL CONDITIONS Articles "COOPERATION WITH UTILITIES" and "COOPERATION BETWEEN CONTRACTORS."

124. CONSTRUCTION OVER OR ADJACENT TO NAVIGABLE WATERS

All Work over, on, or adjacent to navigable waters shall be so conducted that free navigation of the waterways is not interfered with, and that the existing navigable depths are not impaired except as allowed by permit issued by USCG or USACE, as applicable.

125. BARRICADES, WARNING SIGNS AND HAZARD MARKINGS

The Contractor shall provide, erect, and maintain all necessary barricades, marking for hazards, suitable and sufficient lights, danger signals, signs, and other traffic control devices in accordance with the New Jersey Department of Transportation Standard Specifications Section 617, and shall take all necessary precautions for the protection of the Work and safety of the public.

On Port projects when the work requires closing an MARINE TERMINAL OPERATIONS area of the Port or portion of such area, the Contractor shall furnish, erect, and maintain temporary markings and associated lighting conforming to the requirements of AC 150/5340-1, Marking of Paved Areas on Ports. The Contractor shall furnish, erect, and maintain markings and associated lighting of open trenches, excavations, temporary stock piles, and his/her parked construction equipment that may be hazardous to the operation of emergency fire-rescue or maintenance vehicles on the Port in reasonable conformance to AC 150/5370-2, Operational Safety on Ports During Construction Activity. The Contractor shall identify each motorized vehicle or piece of construction equipment in reasonable conformance to AC 150/5370-2. The Contractor shall furnish and erect all barricades, warning signs, and markings for hazards prior to commencing work which requires such erection and shall maintain the barricades, warning signs, and markings for hazards until their dismantling is directed by the Engineer. Open-flame type lights shall not be permitted within the MARINE TERMINAL OPERATIONS areas of the Port.

126. USE OF EXPLOSIVES

When the use of explosives is necessary and approved by the Engineer for the prosecution of the Work, the Contractor shall exercise the utmost care not to endanger life or property, including new Work. The Contractor shall be responsible for all damage resulting from the use of explosives. A pre-blasting meeting will be scheduled by the Engineer with the Office of Safety Compliance. The Contractor shall attend the pre-blasting meeting. No blasting will be permitted prior to the pre-blasting meeting.

All Explosives shall be stored safely under lock and key. The storage places shall be marked plainly DANGEROUS EXPLOSIVES. The storing and handling of explosives and highly inflammable materials shall conform to the regulations of the New Jersey Department of Transportation Office of Safety Compliance, Mine Safety and Explosives, New Jersey Department of Labor, and to local regulations relating thereto. Proper means shall be used to avoid blasting damage to public and private property. Flaggers shall be provided, when necessary, who shall warn and keep traffic from the danger area, and all persons within the danger area shall be warned and given time to withdraw.

The Contractor shall notify each property owner and public utility company having structures or facilities in proximity to the site of the work of his/her intention to use explosives. Such notice shall be given sufficiently in advance to enable them to take such steps as they may deem necessary to protect their property from injury.

The use of electrical blasting caps shall not be permitted on or within 1,000 feet of the Port property.

127. PROTECTION AND RESTORATION OF PROPERTY MARKERS AND LAND MONUMENTS

The Contractor shall be responsible for the preservation of all public and private property markers and shall protect carefully from disturbance or damage all land monuments and property markers until the Engineer has referenced their location. Monuments and markers shall not be moved until directed. All Geodetic Control Markers such as monuments, disks, and benchmarks within the Project site shall be carefully protected and shall not be disturbed by construction activity. Where such markers are located within the Project and are in danger of destruction or disturbance, the Contractor shall retain qualified surveying personnel and shall ensure the markers' relocation prior to disturbing the original markers. All survey work shall be in accordance with the Geodetic Mark Preservation Guidebook as prepared by National Geodetic Survey. Copies of the guidebook are available from the Geodetic Control Survey Unit, New Jersey Department of Transportation, CN 600, Trenton, New Jersey 08625.

128. FOREST PROTECTION

In carrying out work within or adjacent to State or National Forests or Parks, the Contractor shall comply with all regulations of the State Fire Warden, State Division of Parks and Forestry, or other Owner having jurisdiction, governing the protection of forests and the carrying out of work within forests, and shall observe all sanitary laws and regulations with respect to the performance of work in forest areas. The Contractor shall keep the areas in an orderly condition, dispose of all refuse, obtain permits for the construction and maintenance of all construction camps, stores, warehouses, residences, latrines, cesspools, septic tanks, and other structures in accordance with the requirements of the Division or such other Owner.

The Contractor shall take all reasonable precautions to prevent forest fires and shall require its employees and Subcontractors, both independently and at the request of Forestry officials, to do all reasonably within their power to prevent and assist in preventing forest fires, and to make every possible effort to notify a Forestry official at the earliest possible moment of the location and extent of any fire seen by them.

129. OPENING SECTIONS OF PROJECT TO TRAFFIC

Opening sections of the Project to traffic prior to Completion may be desirable or may be necessary due to conditions inherent in the Work, changes in the Contractor's work schedule, or conditions or events unforeseen at the time the Project was bid. Such openings shall be made only when so directed by the Engineer. Under no condition shall such openings constitute Acceptance or a part thereof, or a waiver of any provisions of the Contract.

The Contract Documents indicate, insofar as possible, which sections are to be opened prior to Completion. The Contractor shall make no claim for and shall have no right to additional compensation or extension of Contract Time for opening sections of the Project to traffic as indicated in the Contract Documents or resulting from partial acceptance or changes in the Contractor's work schedule, or for reasons that are due to the fault of the Contractor or any other party, including utilities.

Additional compensation or extension of Contract Time for completion of other items of Work on sections of the Project opened to traffic for reasons other than those indicated in the preceding paragraph will be made as provided in GENERAL CONDITIONS Article "PAYMENT FOR MODIFICATIONS" or in a Supplementary Agreement.

If the Contractor is dilatory in completing shoulders, drainage structures, or other features of the Work, the Engineer may so notify the Contractor in writing and establish therein a reasonable period of time in which the Work is to be completed. If the Contractor is dilatory, or fails to make a

reasonable effort toward completion in this period of time, the Engineer may then order all or a portion of the Project opened to traffic. On such sections which are so ordered to be opened, the Contractor shall conduct the remainder of its construction operations so as to cause the least obstruction to traffic, and shall make no claim for and shall have no right to additional compensation or extension of Contract Time.

On sections of the Project opened to traffic whether indicated in the Contract Documents or not, maintenance of the roadway, runway or taxiway shall be in accordance with GENERAL CONDITIONS Article "MAINTENANCE DURING CONSTRUCTION".

130. INDEPENDENT CONTRACTOR

The relationship of the Contractor to the Owner is that of an independent Contractor, and said Contractor, in accordance with his status as an independent Contractor, covenants and agrees that he shall conduct himself consistent with such status, that he shall neither hold himself out as nor claim to be an officer or employee of the Owner by reason hereof. The Contractor shall not, by reason hereof, make any claim, demand, or application to or for any right or privilege applicable to an officer or employee of the Owner, including, but not limited to, workers compensation coverage, unemployment insurance benefits, social security coverage, or retirement membership or credit.

131. THIRD PARTY BENEFICIARY CLAUSE

It is specifically agreed between the parties executing the Contract that no provision of the Contract is intended to make the public or any member thereof a third party beneficiary hereunder, or to authorize anyone not a party to the Contract to maintain a suit for personal injuries or property damage pursuant to the terms or provisions of the Contract.

It is the further intent of the Executive Director and the Contractor in executing the Contract that no individual, firm, corporation, or any combination thereof, that supplies materials, labor, services, or equipment to the Contractor for the performance of the Work becomes thereby a third party beneficiary of the Contract.

132. LIMITATIONS OF LIABILITY

In any event, whether under the provisions of the Contract, as a result of breach of Contract, tort (including negligence), or otherwise, the Owner will not be liable to the Contractor for any special, consequential, incidental, or penal damages including, but not limited to, loss of profit or revenues, loss of rental value for Contractor-owned equipment, damages to associated equipment, cost of capital, or interest of any nature.

133. ASSIGNMENT OF CONTRACT FUNDS AND CLAIMS

The Contractor shall not transfer or assign to any party any contract funds, due or to become due, or claims of any nature he has against the Owner, without the written approval of the Engineer having first been obtained. The Engineer, by sole discretion, considering primarily the interests of the Owner, may grant or deny such approval.

134. RISK ASSUMED BY THE CONTRACTOR

The Contractor assumes the following distinct and several risks, whether they arise from acts or omissions, whether negligent or not, of the Contractor, his Subcontractors, suppliers, materialmen, employees, agents, and all others working for the Contractor on the Project, of the Owner, or of third persons, or from any other cause, and whether such risks are within or beyond the control of the Contractor described in Subheadings A through C below. Excepted from this assumption of

risks are only those risks which arise from solely affirmative acts done by the Owner subsequent to the execution of the Contract with actual and willful intent to cause loss, damage, and injury. The risks are as follows:

- A. Risks of Loss or Damage to the Permanent Construction - Until Acceptance, the Contractor shall bear the risk of loss or damage to the permanent construction, temporary construction, and to materials, whether or not the Contractor has received payment for such construction or materials under GENERAL CONDITIONS Article "PARTIAL PAYMENTS," or "FINAL PAYMENT." The Contractor shall take every precaution against injury or damage to any part of the construction or to materials by the action of the elements or from any other cause, whether arising from the execution or the non-execution of the Work. The Contractor shall promptly repair, replace, and make good any such loss or damage without cost to the Owner. However, the Contractor shall not bear such risk of loss or damage which arises from acts of war or floods, tidal waves, earthquakes, cyclones, tornadoes, hurricanes, or other cataclysmic natural phenomenon unless such loss or damage is covered by insurance.

The Contractor shall, in furtherance of the above paragraph, but not by way of limitation, at the Contractor's expense, provide suitable drainage for the Project and erect such temporary structures where necessary to protect the Work from damage. The risks for failure to take such actions shall be assumed by the Contractor.

In case of suspension of the Work from any cause whatever, the Contractor shall continue to be responsible for the Project as provided above and shall take such precautions as may be necessary to prevent damage to the Project, provide for drainage, and shall erect any necessary temporary structures, signs, or other facilities. During such period of suspension of the Work, the Contractor shall properly and continuously maintain in an acceptable growing condition all living material in newly established plantings, seedings, and soddings furnished under the Contract, and shall take adequate precautions to protect new tree growth and other important vegetative growth against injury. If ordered by the Engineer, the Contractor shall properly store, during such suspension of the Work, materials which have been partially paid for or furnished by the Owner. The Owner will be entitled to the possession of such materials, and the Contractor shall promptly return the same to the Project site when requested. The Contractor shall not dispose of any of the materials so stored except on written authorization. The Contractor shall be responsible for the loss of or damage to such materials.

- B. Risks of Claims on Account of Injury, Loss, or Damage - The Contractor shall bear the risk of claims, just or unjust, by third persons made against the Contractor or the Owner, on account of injuries (including wrongful death), loss, or damage of any kind whatsoever arising or alleged to arise out of or in connection with the performance of the Work. The risk of claims, whether or not actually caused by or resulting from the performance of the Work or out of or in connection with the Contractor's operations or presence at or in the vicinity of the construction site or Owner premises, whether such claims are made and whether such injuries, loss, and damages are sustained, applies at any time both before and after Acceptance.
- C. Risk of Loss to Property of Those Performing the Work - The Contractor shall bear the risk of loss or damage to any property of the Contractor, and of claims made against the Contractor or the Owner for loss or damage to any property of Subcontractors, materialmen, workers, and others performing the Work, and to

lessors. Said risk occurs at any time prior to completion of removal of such property from the construction site or the Owner's premises, or the vicinity thereof.

The Contractor shall indemnify and save harmless the Owner against all claims described in Subheadings B and C above, and for all expense incurred by the Owner in the defense, settlement, or satisfaction thereof including expenses of attorneys. If so directed, the Contractor shall at its own expense defend against such claims, in which event it shall not, without obtaining express advance permission from the Owner, raise any defense involving in any way jurisdiction of the tribunal, immunity of the Owner, governmental nature of the Owner, or the provisions of any statutes respecting suits against the Owner.

The provisions of this Article are also for the benefit of all officers, agents, and employees of the Owner so that they have all the rights which they would have under this Article if they were named at each place above at which the Owner is named, including a direct right of action against the Contractor to enforce the foregoing indemnity except, however, that the Owner may at any time in its sole discretion and without liability on its part cancel the benefit conferred on any of them by this Article, whether or not the occasion for invoking such benefit has already arisen at the time of such cancellation.

Neither Acceptance nor the making of final payment releases the Contractor from his obligations under this Article. Moreover, neither the enumeration in this Article nor the enumeration elsewhere in this Contract of particular risks assumed by the Contractor or of particular claims for which he is responsible shall be deemed:

- A. To limit the effect of the provisions of this Article or of any other provision of the Contract relating to such risks or claims, or
- B. To imply that the Contractor assumes or is responsible for risks or claims only of the type enumerated in this Article or in any Contract, or
- C. To limit the risks which the Contractor would assume or the claims for which the Contractor would be responsible in the absence of such enumerations.

The Contractor expressly understands and agrees that any insurance protection required by the Contract, or otherwise provided by the Contractor, in no way limits the Contractor's responsibility to defend, indemnify, and save harmless the Owner as herein provided. Such insurance requirements are designed to provide greater assurance to the Owner that the Contractor is financially able to discharge his obligations under this Article and as to the risks assumed elsewhere in the Contract, and are not in any way construed as a limitation on the nature and extent of such obligations.

135. DISPUTES

Except for specific provisions otherwise set forth in the Contract Documents, any dispute concerning questions of fact or circumstance arising out of this Contract shall be mutually resolved through good faith mediation between the Contractor and the Owner. No work shall be delayed or postponed pending resolution of any disputes or disagreements, except as the Contractor and the Owner may otherwise agree in writing.

Any dispute arising under or relating to this Contract, which is not disposed by mutual agreement, may be submitted by the Contractor, for a hearing, before the Owner's Executive Director. The Contractor's right to request such a hearing is conditioned upon compliance with the requirements of Article "DUTIES AND RESPONSIBILITIES OF THE ENGINEER," of these GENERAL CONDITIONS. If the Contractor is not satisfied with the decision of the Engineer, the Contractor may, within fifteen (15) days from the receipt of the Engineer's final determination based upon the Contractor's written objection, file a request before the Owner's Executive Director.

The Owner's Executive Director, or his designee, shall hold a hearing of the dispute, and his decision shall be reduced to writing and a copy thereof mailed or otherwise furnished to the Contractor. The decision of the Executive Director or his designee, shall be considered final and conclusive unless, within fifteen (15) days of receipt of a copy of the decision, the Contractor notifies the Owner of his objections to such decision. Failure to file a written objection within the allotted time, shall be considered acceptance of the decision, and the decision shall become final and conclusive.

The request for such a hearing before the Owner's Executive Director, or his designee, the holding of the hearing, and the receipt of the decision shall be a condition precedent to the right to request arbitration or initiate court action.

136. ARBITRATION

If agreed upon in writing by the Contractor and Owner in an unsettled dispute, any controversy arising out of or relating to this Contract, or the breach thereof, may be settled by arbitration in accordance with Construction Industry Arbitration Rules of the American Arbitration Association and judgement upon the award rendered by the arbitrator or arbitrators may be entered in any court having jurisdiction thereof.

The Contractor shall not delay the work because arbitration proceedings are pending, unless he shall have written permission from the Owner to do so. Such delay shall not extend beyond the time when the arbitrators shall have opportunity to determine whether the work shall continue or be suspended pending decision by the arbitrators of such a dispute. Any request for arbitration shall be in writing and shall be delivered to the Engineer and any adverse party either by personal delivery or by registered mail addressed to the last known address of the parties in dispute.

137. HEADINGS

The headings of the various Articles contained herein are inserted for convenience of reference only and shall not constitute a part hereof, nor limit or define the terms and conditions hereof.

138. RESERVED

139. RESERVED

MAINTENANCE BOND, INSURANCE, AND INDEMNIFICATION

140. MAINTENANCE BOND

Upon completion of all required work and prior to final payment the Contractor shall provide a two (2) year Maintenance Bond to the Owner for 100% of the final contract price.

141. DEFAULT OF SURETY

If the Surety on any bond furnished by the Contractor is placed under any Federal or State rehabilitation, liquidation, receivership or bankruptcy proceedings, of any kind, the Owner, at his discretion, shall have the right to require the Contractor to take immediate steps to secure a replacement bond and Surety, both of which shall be acceptable to the Owner, at the sole expense of the Contractor. Failure by the Contractor to provide a replacement bond and Surety as required by the Owner within ten (10) days thereafter shall be cause for the Owner to exercise his rights under Article "SUSPENSION OF WORK" of these GENERAL CONDITIONS or terminate the

Contract for material breach. In addition, no further progress payments under the Contract shall be made by the Owner until the Contractor complies with the provisions of this Article.

142. INSURANCE AND LIABILITY

1. Prior to the commencement of any work or services and until completion / final acceptance of the work as described in the Scope of Services in this Contract, the Contractor will provide and maintain the following minimum levels of insurance at Contractor's own expense. The cost of the required insurance shall be included in the Contractor's bid price and no adjustment shall be made to the contract price on account of such costs unless such approval is provided. The term Contractor shall include "Professional Service Contractors" as well as Subcontractors and Sub-Subcontractors of every tier. Contractor shall furnish Certificates of Insurance evidencing and reflecting the effective date of coverage as outlined below. The Services shall not commence until the Contractor has obtained, at their own expense, all of the insurance as required hereunder and such insurance has been approved by the South Jersey Port Corporation (the "Owner"). Approval of insurance required of the Contractor will be granted only after submission to the Owner of original certificates of insurance signed by the representatives of the insurers or, at the Owner's request, certified copies of the required insurance policies. If found to be non-compliant at any point during the Contract Term, the Owner may purchase the required insurance coverage(s) and the cost will be borne by the Contractor through direct payment/reimbursement to the Owner or the Owner may withhold payment to the Contractor for amounts owed to them. The required insurance shall not contain any exclusions or endorsements which are not acceptable to the Owner. Failure of the Owner to demand such certificate or other evidence of full compliance with these insurance requirements or failure of the Owner to identify a deficiency from evidence that is provided shall not be construed as a waiver of Contractor's obligation to maintain such insurance. With respect to insurance maintained after final payment in compliance with a requirement below, an additional certificate(s) evidencing such coverage shall be provided to the Owner with final application for payment and thereafter upon renewal or replacement of such insurance until the expiration of the time period for which such insurance must be maintained.
2. The Contractor shall require all Subcontractors to maintain during the term of the Contract Insurance of the type and in the minimum amounts as described below and required of the Contractor. Any obligations imposed upon the Contractor as part of this contract shall be so imposed upon any and all Subcontractors as well.
3. All insurance required herein, with the exception of the Professional Liability Insurance, shall be written on an "occurrence" basis and not a "claims-made" basis. For Professional Liability "claims-made" coverage:
 - a. The retroactive date must be on or prior to the start of work under this contract; and
 - b. The Contractor must purchase "tail coverage/an extended reporting period" or maintain coverage for a period of two (2) years subsequent to the completion of their work / final payment.
4. The South Jersey Port Corporation, its commissioners, agents, servants, employees and representatives shall be named as additional insured on the Contractor's liability insurance program (except Workers Compensation and Professional Liability policies) for ongoing operations and completed operations on a primary noncontributory basis. Coverage to include ongoing and completed operations using ISO Endorsements CG 2010 and CG 2037, or their equivalents. Each of the Additional Insured's respective members, employees, agents and representatives shall also be afforded coverage as an Additional Insured. Coverage should be provided for a period of two years subsequent to the completion of work/final payment. The Owner reserves the right to require the Contractor to name other parties as additional insureds as required by the Owner. There shall

be no "Insured versus Insured Exclusion" on any policies; all policies will provide for "cross liability coverage".

5. All insurance policies required hereunder shall be endorsed to provide that the policy is not subject to cancellation, non-renewal, or material reduction in coverage until thirty (30) days prior written notice has been given to the Owner. In the event of cancellation or non-renewal of coverage(s), it is the Contractor's responsibility to replace coverage to comply with the Contract requirements so there is no lapse of coverage for any time period. In the event the insurance carriers will not issue or endorse their policy(s) to comply with the above it is the responsibility of the Contractor to report any notice of cancellation or non-renewal at least thirty (30) days prior to the effective date of this notice.
6. No acceptance and/or approval of any insurance by the Owner shall be construed as relieving or excusing the Contractor or the Contractor's Surety from any liability or obligation imposed upon either or both of them by provisions of this Contract.
7. Any deductibles or self-insured retention's (SIR) of \$10,000 or greater shall be disclosed by the Contractor, and are subject to the Owner's written approval. Any deductible or retention amounts elected by the Contractor or imposed by the Contractor's insurer(s) shall be the sole responsibility of the Contractor. In the event any policy includes an SIR, the Contractor is responsible for payment within the SIR of their policy(ies) and the Additional Insured requirements specified herein shall be offered within the SIR amount(s).
8. All insurance companies shall have an AM Best's rating of at least "A-, Class VIII" or better and be permitted to do business in the State of New Jersey.
9. There shall be no liability upon the Owner, public officials, their employees, their authorized representatives, or agents either personally or as officials of the Owner in carrying out any of the provisions of the Contract nor in exercising any power or Owner granted to them by or within the scope of the Contract, it being understood that in all such matters they act solely as agents and representatives of the Owner.
10. Waiver of Rights of Recovery and Waiver of Rights of Subrogation:
 - a. The Contractor waives all rights of recovery against the Owner and all the additional insureds for loss or damage covered by any of the insurance maintained by the Contractor.
 - b. If any of the policies of insurance required under this contract require an endorsement to provide for the waiver of subrogation, then the named insured of such policies will cause them to be so endorsed.
11. Any type of insurance or any increase in limits of liability not described above which the Contractor requires for its own protection or on account of statute shall be its own responsibility and at its own expense.
12. The amount of insurance provided in the aforementioned insurance coverages, shall not be construed to be a limitation of the liability on the part of the Contractor.
13. Contractor shall promptly notify the Owner and the appropriate insurance company(ies) in writing of any accident(s) as well as any claim, suit or process received by the insured Contractor arising in the course of operations under the Contract. The Contractor shall forward such documents received to his/her insurance company(ies), as soon as practicable, or as required by his/her insurance policy(ies).

REQUIRED COVERAGE: the following may be provided through a combination of primary and excess policies in order to meet the minimum limits set forth below:

B. CONTRACTOR'S LIABILITY INSURANCE REQUIREMENTS:

1. Commercial General Liability insurance for bodily injury, personal injury, and property damage including loss of use, etc. with minimum limits of:
 - \$1,000,000 each occurrence;
 - \$1,000,000 personal and advertising injury;
 - \$2,000,000 general aggregate; and
 - \$2,000,000 products/completed operation aggregate.

This insurance shall include coverage for all of the following

- Coverage is to be provided on ISO CG 00 01 12 07 or an equivalent form ("Occurrence Form") including Premises/Operations, Independent Contractors, Products/Completed Operations, Broad Form Property Damage, Contractual Liability, and Personal Injury and Advertising Injury;
 - General aggregate limit applying on a per project basis;
 - Products/Completed Operations Coverage must be maintained for a period of at least two (2) years after final payment (including coverage for the Additional Insureds as set forth in these Insurance Requirements);
 - No exclusions for development, construction, building conversion, etc. with respect to the project's location and/or where the work is to be completed by the Contractor;
 - Coverage for "Resulting Damage";
 - No sexual abuse or molestation exclusion;
 - No amendment to the definition of an "Insured Contract".
2. Business Auto Liability insurance with a minimum combined single limit of \$1,000,000 per accident and including, but not limited to, coverage for all of the following:
 - Liability arising out of the ownership, maintenance or use of any auto;
 - Auto non-ownership and hired car coverage
 - Contractual Liability Coverage (including Liability for Employee Injury assumed under a Contract as provided in the standard ISO policy form)
 - For Contractors involved in the transportation of hazardous material, include the following endorsements: MCS-90 and ISO-9948
 3. Workers' Compensation insurance with statutory benefits as required by any state or federal law, including standard "other states" coverage; employer's liability insurance with minimum limits of:
 - \$1,000,000 each accident for bodily injury by accident;
 - \$1,000,000 each employee for bodily injury by disease; and
 - \$1,000,000 policy limit for bodily injury by disease.
 1. United States Longshore & Harbor Workers Act Coverage, where applicable.
 2. Includes Sole Proprietorships and Officers of a Corporation who will be performing the work.
 3. Where applicable, if the Contractor is lending or leasing its employees to the Owner for the work under this contract (e.g. crane rental with operator), it is the Contractor's responsibility to provide the Workers Compensation and Employer's Liability coverage and to have their policy endorsed with the proper Alternate Employer Endorsement.

4. Professional Liability (If Designated by Contractor's Scope of Work): Contractors (such as, but not limited to Architects, Engineers, Attorneys, Financial Advisors, Marketing, Physicians and Risk Management Consultants) shall provide liability and/or malpractice insurance with minimum limits of \$3,000,000. The definition of "covered services" shall include the services required in the scope of this contract.

5. Umbrella Liability or Excess Liability insurance with minimum limits of:

\$10,000,000	per occurrence;
\$10,000,000	aggregate for other than products/completed operations and auto liability; and
\$10,000,000	products/completed operations aggregate.

Policy to apply on a Following Form basis of the Commercial General Liability, Commercial Automobile Liability and Employers Liability Coverage.

6. Pollution Liability Insurance (If Designated by Contractor's Scope of Work):

- Covering losses caused by pollution incidents that arise from the operations of the Contractor described under the scope of services of this contract. This is to include all work completed by the Contractor, including testing and / or removal of any and all pollutants.
- Occurrence/Claims Made Limit: \$1,000,000 per project
- Insurance to be maintained for the duration of the work and for a period of two (2) years after completion of work / final payment.
- No Exclusions for Silica, Asbestos, Lead, or Lead Based Paint Testing.
- Include Mold Coverage for full policy limit of liability.
- Shall include coverage for all pollutants as defined under the Resource Conservation and Recovery Act, as amended, 42 U.S.C. Section 6901 et. Seq. ("RCRA") or any related state or city environmental statute or the removal of any petroleum contaminated material.
- All owned and / or 3rd Party disposal facilities must be licensed and maintain pollution liability insurance of not less than \$1,000,000, if applicable.

7. Watercraft Liability (If Designated by Contractor's Scope of Work): If Contractor utilizes any owned, used, leased, hired or borrowed watercraft to complete their work in accordance with this Contract, the coverage shall be maintained.

Minimum Limits of Liability:
\$2,000,000 Per Occurrence
\$2,000,000 Aggregate

8. Aircraft Liability and/or Unmanned Aircraft Systems (UAS, aka Drones) (If Designated by Contractor's Scope of Work): If Contractor utilizes any owned, leased, hired, or borrowed aircraft or UAS, coverage for bodily injury, property damage, personal and advertising injury arising out of the above shall be maintained.

Minimum Limits of Liability:
\$10,000,000 Per Occurrence
\$10,000,000 Aggregate

NOTE: If UAS are covered by the General Liability policy instead of an Aviation Policy, coverage must be provided by CG 24 50 (or its equivalent) for "any aircraft used in the Insured's operations" for "any operations or projects of the Insured".

9. **Crime (If Designated by Contractor's Scope of Work)**
 - Include the Employee Theft and Theft, Disappearance and Destruction coverage parts.
 - The Employee Theft Coverage part shall include the Clients' Property Endorsement (ISO Form CR 04 01, or its equivalent).
 - Minimum Limits of Liability: \$1,000,000 Per Occurrence

10. **Privacy Liability (If Designated by Contractor's Scope of Work)**
 - Contractor shall maintain coverage for third party liability arising out of breach of privacy, inclusive of confidential and proprietary business information, HIPAA violations and other breaches of personally identifiable information and/or protected health information, which may arise from their work with this contract.
 - Minimum Limits of Liability: \$1,000,000 Per Claim / \$1,000,000 Aggregate
 - Privacy Breach Notification and Credit Monitoring: \$250,000 Per Occurrence

11. **Property Coverage (If Designated by Contractor's Scope of Work)**
 - Contractor shall provide coverage for damage to their work, materials to be part of the project (on-site and off-site), and in transit.
 - Valuable Papers coverage is to be included with a minimum \$500,000 Limit.

12. **Owned, Leased, Rented or Borrowed Equipment (If Designated by Contractor's Scope of Work):**
 - Contractor shall maintain Property Coverage for their owned, leased, rented or borrowed equipment, tools, trailers, etc.

INDEMNIFICATION

To the extent that state and/or federal laws limit the terms and conditions of this clause, it shall be deemed so limited to comply with such state and/or federal law. This clause shall survive termination of this contract. The Contractor shall protect, defend, indemnify and hold harmless the Owner, its commissioners, agents, servants, employees, and representatives (the "Indemnified Parties") from and against all liability, (including liability for violation of any law or any common law duty) claims, damages, losses, and expenses including attorneys' fees arising in connection with, out of, or resulting from the performance of the work, provided that any such liability, claim, damage, loss or expense (i) is attributable to bodily injury, sickness, disease, or death, or to any statutory or regulatory rule designed to protect against such conditions, or to injury to or destruction of tangible property (other than the work itself), and including the loss of the use resulting there from, and (ii) is caused by or results from, in whole or in part, any act or omission of the Contractor, or any Subcontractor, or anyone direct or indirectly employed by any of them or anyone for whose acts any of them may be liable, regardless of whether or not it is also caused by or results from any act or omission of any party indemnified hereunder. Such obligation shall not be construed to negate, abridge, or reduce other rights, obligations or indemnity which would otherwise exist as to a party or person described in this Indemnification.

In any and all claims against the Indemnified Parties by an employee of the Contractor, or Subcontractor, or anyone directly or indirectly employed by any of them, or anyone for whose acts any of them may be liable, the indemnification obligation shall not be limited in any way by any limitation on the amount or type of damages, compensation or benefits payable by or for any Contractor, or Subcontractor under Workmen's Compensation Acts, Disability Benefits Acts, or other Employee Benefit Act.

These Indemnification provisions shall survive the termination of this contract.

PROSECUTION AND PROGRESS OF THE WORK

143. ASSIGNMENT

The Contractor shall not assign, transfer, convey or otherwise dispose of this Contract or any of the proceeds thereunder unless written consent of the Owner has been obtained. No right under this Contract or claim for any proceeds due or to become due hereunder shall be asserted against the Owner, or persons acting for the Owner, by reason of any so-called assignment, transfer or conveyance of this Contract or any part thereof unless such assignment, transfer or conveyance has been authorized by the written consent of the Owner. The instrument of assignment, transfer or conveyance shall contain a clause subordinating the claim of the assignee transferee or conveyee to all prior liens for services rendered for materials supplied for the execution of the work.

144. SUBCONTRACTING

The Contractor shall not employ any Subcontractor who was not named by the Contractor as a proposed Subcontractor as specified in the PROPOSAL SECTION, without written approval or authorization of the Owner.

The Contractor agrees that he is as fully responsible to the Owner for the acts and omissions of his Subcontractors or suppliers at any tier and of persons either directly or indirectly employed by them as he is for the acts and omissions of persons directly employed by him.

The Contractor shall include in his agreements with Subcontractors, including suppliers and manufacturers of equipment, the provisions and requirements of these Contract Documents as applicable to their part of the work included under this Contract, together with such provisions as may be required pursuant to applicable laws. Nothing contained in the Contract Documents shall create any contractual relationship between the Owner or the Engineer and any Subcontractor or sub-Subcontractor.

Subject to the provisions of this Article and to the consent of the Executive Director, Work may be subcontracted except that the item of mobilization or any part thereof shall not be subcontracted. It is understood, however, that any consent of the Owner for the subcontracting of any Work of the Contract in no way relieves the Contractor from its full obligations for all Work under the Contract, nor the surety of its obligations under the bond. The Contractor shall at all times give its personal attention to the fulfillment of the Contract and shall keep the Work under control. The Contractor shall be responsible for all work of Subcontractors which work shall conform to the provisions of the Contract Documents. The consent to the subcontracting of any part of the Work shall not be construed as an approval of the said subcontract or of any of its terms, but is to operate only as an approval of the Contractor's request for the making of a subcontract between the Contractor and its chosen Subcontractor.

The Contractor shall perform with his own organization Contract Work amounting to at least 50 percent of the original total contract price except as follows:

- A. If the Contract Documents include Pay Items designated as "Specialty Items," the Contractor may deduct the value of these items from the original total Contract price before computing the amount of work to be performed by his own organization.
- B. The Contractor may deduct from the amount of work to be performed by his own organization the value of all Pay Items subcontracted to certified D/WBE firms indicated on the original DBE Form approved by the Owner.

In no event shall the Contractor perform, with his own organization, work amounting to less than 30 percent of the original total Contract price reduced in accordance with Item A above.

Where an entire item is subcontracted, the value of Work subcontracted will be determined based on the Pay Item Contract price. When part of the quantity of a unit price item is subcontracted, the value of the work subcontracted will be determined by multiplying the Contract unit price by the quantity performed by the Subcontractor. If the Subcontractor performs part of the work of any unit of a unit price item, that entire unit will be considered to be subcontracted and the value of the work subcontracted will be determined by multiplying the Contract unit price by the number of units of the quantity considered to be subcontracted. When a portion of a lump sum item or an item which includes specialty work is subcontracted, the value of Work subcontracted will be determined based on the estimated cost of the Work to be subcontracted as determined from the breakdown of cost submitted by the Contractor. When part of a sign support structure is subcontracted, the provisions for a lump sum item govern.

Application for subcontracting any part of the Work shall be made by the Contractor on forms furnished by the Owner. That form, fully completed in quadruplicate, one (1) original and three (3) copies, shall be furnished to the Engineer. The Contractor shall attach to that form a certified copy of the executed subcontract between the Contractor and the Subcontractor. The copy of the subcontract will be used in the review of the application.

After review of the application, the consent of or rejection by the Owner of the subcontracting will be provided to the Contractor in writing. Prior to the receipt of the written consent from the Owner, Work shall not be performed on the Project under the subcontract.

Subcontracting will not be permitted to firms and individuals suspended or debarred by the State of New Jersey Department of Transportation or included in the Report of Suspensions, Debarments, and Disqualifications of Firms and Individuals as maintained by the New Jersey Department of the Treasury, Division of Building and Construction, Bureau of Contractor Prequalification.

Subcontracting of those electrical items, which require electricians will be permitted only to Subcontractors who are licensed electricians in the State of New Jersey regardless of the value of the subcontract.

The Subcontractor shall look only to the Contractor for the payment of any claims of any nature whatsoever arising out of the subcontract. The Subcontractor agrees, as a condition of the Owner's consent to the making of the subcontract, that the Subcontractor shall make no claims against the Owner or its agents or employees for any Work performed or thing done by reason of the subcontract, or for any other cause that may arise by reason of the relationship created between the Contractor and Subcontractor by the subcontract.

Additionally, the Contractor shall give assurances, prior to the Owner's giving consent, that when minimum wage rates are specified they shall apply to labor performed on all subcontracted Work.

The Owner will not consent to the making of any subcontract unless the proposed Subcontractor furnishes a statement to the effect that the Subcontractor is acquainted with all of the provisions of the Contract.

145. OTHER CONTRACTS

The Owner may let other contracts in connection with the work. The Contractor shall afford other Contractors reasonable opportunity for the introduction and storage of their materials, and shall

cooperate as necessary to provide for the orderly and timely execution of their work, and shall properly connect and coordinate his work with theirs.

If any part of work under this Contract depends on the prior acceptable completion of work under separate contract(s), the Contractor for this Contract shall inspect the existing conditions that are to receive his work and promptly provide a written report to the Engineer describing any defects in such existing conditions that would adversely affect the satisfactory completion of the work under this Contract. The Contractor's failure to so inspect and report shall constitute acceptance of the work under separate contract(s) as being suitable for the proper reception and completion of the work under this Contract, excluding, however, those defects in the work by others that occur after the satisfactory completion of the work specified hereunder:

146. COMMENCEMENT OF WORK

Upon execution of the Contract by the Owner, a fully executed copy together with a Notice to Proceed will be provided to the Contractor. Receipt of the executed Contract and Notice to Proceed shall constitute the Contractor's Owner to enter upon the Project site, provided the Contractor has submitted to the Engineer, and the Engineer has accepted, the insurance certificates required under GENERAL CONDITIONS Article "INSURANCE AND LIABILITY" and a pre-construction conference has been held. Construction operations shall not begin until the Contractor has supplied, and the Engineer has accepted, the progress schedule and other certifications, forms, schedules, and any other information required by the Contract Documents, and until the Contractor has established a field office as required by Contract Documents. The Contractor shall begin the work to be performed under the contract within 14 calendar days of the date set by the Engineer in the written notice to proceed, but in any event, the Contractor shall notify the Engineer at least 24 hours in advance of the time actual construction operations will begin. Failure to begin construction operations within 14 calendar days shall constitute a default for which the Owner may take whatever action that is deemed appropriate under the Contract.

147. PROSECUTION OF THE WORK

It is expressly understood and agreed that the time of beginning, rate of progress, and time of completion of the work are the essence of this Contract and are the responsibility of the Contractor. The Contractor should schedule the work and provide proper resources, labor, equipment and material to complete the project within the Time of Completion. The work shall be executed as required in the Contract Documents.

At or prior to the pre-construction meeting, the Contractor shall furnish the name and location of the solid waste facilities to be used as well as the fee structure of each of the facilities. Failure to provide such information will make the Contractor ineligible for adjusted compensation as provided for in GENERAL CONDITIONS Article "CHANGES IN CHARACTER OR WORK."

148. LIMITATION OF OPERATIONS

The Contractor shall conduct the Work at all times in such a manner and in such sequence that shall ensure the least interference with traffic. The Contractor shall have due regard for the location of detours and for the provisions for handling traffic. The Engineer may require the Contractor to finish a section on which Work is in progress before Work is started on any additional sections if the opening of such section is essential to public convenience.

When the work requires the Contractor to conduct his operations within an MARINE TERMINAL OPERATIONS AREA of the Port, the work shall be coordinated with Port management (through the Engineer) at least 48 hours prior to commencement of such work. The Contractor shall not close an OPERATIONS AREA until so authorized by the Engineer and until the necessary

temporary marking and associated lighting is in place as provided in the Article titled "BARRICADES, WARNING SIGNS, AND HAZARD MARKINGS."

When the contract work requires the Contractor to work within an MARINE TERMINAL OPERATIONS AREA of the Port on an intermittent basis (intermittent opening and closing of the MARINE TERMINAL OPERATIONS AREA), the Contractor shall maintain constant communications as hereinafter specified; immediately obey all instructions to vacate the MARINE TERMINAL OPERATIONS AREA; immediately obey all instructions to resume work in such MARINE TERMINAL OPERATIONS AREA. Failure to maintain the specified communications or to obey instructions shall be cause for suspension of the Contractor's operations in the MARINE TERMINAL OPERATIONS AREA until the satisfactory conditions are provided.

149. CHARACTER OF WORKERS

The Contractor shall at all times employ sufficient labor and equipment for prosecuting the several classes of Work to full completion in the manner and time required by the Contract Documents.

All workers shall competent and have sufficient skill and experience to properly perform the Work assigned to them. Workers engaged in special Work or skilled Work shall have sufficient experience in that Work and in the operation of the equipment required to perform the Work satisfactorily. The Contractor shall provide sufficient competent, skillful employees to complete the work in the allotted time by the Time of Completion.

Any person employed by the Contractor or by any Subcontractor who, in the opinion of the Engineer, does not perform Work in a proper and skillful manner or is intemperate or disorderly shall, at the written request of the Engineer, be promptly removed by the Contractor or Subcontractor employing the person and shall not be again employed in any portion of the Work without approval. Should the Contractor fail to remove such person or persons as required, or fail to furnish suitable and sufficient personnel for the proper prosecution of the Work, the Engineer may suspend the Work by written notice until compliance with such orders.

Except for regularly retired employees, the Contractor and its Subcontractors shall not, without the written consent of the public employer of such person, engage on a full, part-time, or other basis, during the period of the Contract, any of the professional or technical personnel of the South Jersey Port Corporation.

150. CONTRACTOR'S METHODS, TOOLS AND EQUIPMENT

The Contractor's tools and equipment used on the work shall be furnished in sufficient quantity and of a capacity and type that will perform the work specified and in the time allotted by the Time of Completion. All equipment which is proposed to be used on the Work shall be of sufficient size and in such mechanical condition as to meet the requirements of the Work and to produce a satisfactory quality of Work.

Tools and Equipment used on any portion of the Project shall not cause damage to the roadway, adjacent property, or other highways. They shall be maintained and used in a manner that will not create a hazard to persons or property or cause a delay in the progress of the work.

When the methods and equipment to be used by the Contractor in accomplishing the construction are not specified, the Contractor is free to use any methods or equipment that accomplishes the Work. When the use of certain methods and equipment is specified, the specified methods and equipment shall be used unless otherwise authorized in accordance with GENERAL CONDITIONS Article "SUBSTITUTES OR "OR EQUAL" ITEMS."

151. OWNER'S RIGHT TO CORRECT DEFECTIVE WORK

If the Contractor should, in the opinion of the Engineer, neglect to execute the Work properly or should neglect or refuse at his own cost to take up and replace defective work that has been rejected by the Engineer, then the Owner will notify his Surety of the condition. After ten (10) days (or such longer period as the Owner may allow) written notice to the Contractor and the Surety, and without prejudice to any other right which the Owner may have under the contract, the Owner may take over that portion of the work that has been improperly executed and make good the deficiencies and deduct the cost thereof from the payments then or thereafter due the Contractor, and if such payments are not sufficient therefor, charge the cost to the Contractor and his Surety.

152. WORKING SITE / USE OF PREMISES

The Contractor shall confine his equipment, the storage of materials, and the operation of his workers to limits indicated in the Contract Documents or required by law, permits, or directions of the Engineer, and shall not unreasonably encumber the premises with his materials. The Contractor shall not use the decks of any completed bridges, or the areas including slopes under any completed bridges, as working sites or storage areas for materials or equipment. The Contractor shall provide, at his own expense, the necessary rights-of-way and access to the work which may be required outside the limits described above and provide evidence of such access rights to the Owner. Except as otherwise provided, any space that the Contractor may require for plant, equipment, storage, or other purposes in addition to that available at the Project site, shall be procured by the Contractor, and the cost thereof shall be included in the prices bid for the various Pay Items scheduled in the Proposal. In the event of default as set forth in GENERAL CONDITIONS Article "TERMINATION FOR DEFAULT, DAMAGES FOR DELAY, TIME EXTENSIONS," the Owner has the right to take over and occupy such space, or cause it to be occupied, for the purpose of completing the Project, at the Contractor's expense. If the space is leased, the lease shall contain a provision that in event of default by the Contractor the lease may be assigned to the Owner or its nominee at their election. The Contractor agrees in event of said default, that it shall make such assignment.

The Contractor shall use every precaution to prevent injury or damage to all underground structures, such as pipes, wires and conduits; to all paved surfaces and to all turfed areas. He shall be responsible for injury or damage of any character resulting from any act, neglect, misconduct in his manner or method of execution or non-execution of said work, and such responsibility shall not be released until the work shall have been completed and accepted. Whenever any such damage or injury is done, the Contractor shall restore, at his own expense, the above to a condition similar or equal to that existing before such damage or injury is done.

The Contractor shall take particular care when new cables are being placed through existing duct banks, which contain existing cables. Any damage caused to existing cable by or during the operations of the Contractor must be repaired immediately at the sole expense of the Contractor.

The maintenance of Port Operations is of the utmost importance and priority on Port projects. The Contractor shall so schedule and conduct his operations and store his materials and equipment so that no unauthorized interference to normal Port operations will result therefrom.

Grading and stockpiling of materials or other construction operations shall not be conducted in a manner to cause malfunction of or interference with the Port traffic control. The Contractor shall plan and execute his work in such a manner that adequate access will be available for vehicular traffic at all times during the period of construction. No trucking or other heavy equipment will be allowed on the paved runways, and at no time shall the speed exceed the limits of the Port. It is expressly understood that the Owner will not be responsible for any deduction, interpretations,

delays, or conclusions made by the Contractor as to the difficulties, which will be encountered in this regard.

Existing lights shall be maintained in full operation throughout the period of this Contract. Where disconnections of lights are required, such work shall be made at such times and in such manner as approved by Port Management. The Contractor shall conduct his operations as required to maintain full use of existing lighting circuits, utilizing temporary cables and connections if necessary.

The Contractor shall secure the Port Operations Area (AOA) with temporary fencing in accordance with the dimensions and locations shown on the drawings.

The cost of maintaining Port operations shall be absorbed by the Contractor in the prices bid for the various items of work with the exception of items specified in the Schedule of Prices.

153. UNUSUAL SITE CONDITIONS

The Contractor shall promptly, and before such conditions are disturbed, notify the Engineer in writing of previously unknown physical conditions at the site of an unusual nature or differing materially from those ordinarily encountered and generally recognized as inherent in Work of the character provided for in the Contract. The Engineer will promptly investigate the conditions, and if the Engineer determines that such conditions are unusual, that they could not have been discovered by the Contractor through employing the high standard of care required under GENERAL CONDITIONS Article "EXAMINATION OF CONTRACT DOCUMENTS AND SITE OF PROJECT", and that they cause an increase or decrease in the cost of, or the time required for, performance of any part of the Work under the Contract, an adjustment, as appropriate, will be made in the Contract Time pursuant to GENERAL CONDITIONS Articles "CLAIMS FOR ADDITIONAL TIME AND/OR COMPENSATION" and "EXTENSION OF TIME" and in compensation to the Contractor pursuant to GENERAL CONDITIONS Articles "CHANGES", "MINOR CHANGES IN THE WORK", "INCREASED OR DECREASED QUANTITIES", "ELIMINATED ITEMS", "EXTRA WORK", "PAYMENT FOR MODIFICATIONS", and "PAYMENT FOR CONTRACTOR'S EXPENSES DURING DELAY".

Claims arising from unusual site conditions are barred unless the Contractor has given the required notice prior to disturbing such conditions.

154. COMPLAINTS

All complaints received by the Contractor shall be reported to the Engineer no later than the working day following receipt thereof. Such reports shall include the name, address, date, time received, date and time of action complained about, and a brief description of the alleged damages or other circumstances upon which the complaint is predicated. Each complaint shall be assigned a separate number, and all complaints shall be numbered consecutively in order of receipt. In the event more than one complaint is received from the same complainant, each later complaint shall show all previous complainant numbers registered by the same complainant. In addition, a summary report shall be made to the Engineer each month which shall indicate the date, time, and name of the person investigating the complaint and the amount of damages claimed (or estimate thereof), including the amount of settlement, if any. When settlement of a claim is made, the Engineer shall be furnished with a copy of the release of claim by the claimant. The Owner shall be notified immediately, throughout the statutory period of liability, of any formal claims or demands made by attorneys on behalf of claimants; of the serving of any notice, summons, subpoena, or other legal documents incidental to litigation; and for any out-of court settlement or court verdicts resulting from litigation.

155. TEMPORARY SUSPENSION OF WORK

The Engineer has the Owner to suspend the Work wholly or in part, for such period as deemed necessary, due to unsuitable weather, or to such other conditions as are considered unfavorable for the suitable prosecution of the Work, or for such time as deemed necessary due to the failure on the part of the Contractor to carry out orders given, or to perform any provision of the Contract. The Contractor shall promptly comply with the written order of the Engineer to suspend the Work wholly or in part. The suspended Work shall be resumed when conditions are favorable and methods are corrected, as ordered or approved in writing.

In the event that a suspension of Work is ordered as provided above, and should such suspension be ordered by reason of the failure of the Contractor to carry out orders or to perform any provision of the Contract; or by reason of weather conditions being unsuitable for performing any item or items of Work, which Work, in the sole opinion of the Engineer, could have been performed prior to the occurrence of such unsuitable weather conditions had the Contractor diligently prosecuted the Work when weather conditions were suitable; the Contractor, at its expense, shall do all the Work necessary to provide a safe, smooth, and unobstructed passageway through the construction area for use by public traffic during the period of such suspension. In the event that the Contractor fails to perform the Work above specified, the Owner will perform such Work and the cost thereof will be deducted from any monies due or that may become due the Contractor.

If the Engineer orders a suspension of all of the Work or a portion of the Work which is the current controlling operation or operations, due to unsuitable weather or to such other conditions as are considered unfavorable to the suitable prosecution of the Work, the days on which the suspension is in effect are not considered working days on working day contracts. If a portion of Work at the time of such suspension is not a current controlling operation or operations, but subsequently does become the current controlling operation or operations, the determination of working days will be made on the basis of the then current controlling operation or operations. Similarly, on calendar day and specified completion date contracts, extensions of Contract Time will be granted only if the suspension affects the overall completion of the Contract and the other requirements of GENERAL CONDITIONS Article "EXTENSION OF TIME" are satisfied.

If a suspension of Work is ordered by the Engineer due to the failure on the part of the Contractor to carry out orders given or to perform any provision of the Contract, the days on which the suspension order is in effect are to be considered working days if such days are working days within the meaning of the definition set forth in GENERAL CONDITIONS Article titled "DEFINITIONS". On calendar day and specified completion date contracts, extensions of Contract Time will not be granted due to such suspension.

The Contractor shall have no claim for additional compensation as a result of suspension ordered for the reasons set forth in this Article, except as to the costs of providing a smooth and unobstructed passageway consistent with the above provisions.

156. SUSPENSION OF WORK

The Owner may order the Contractor in writing to suspend, delay or interrupt all or any part of the work for such period of time as he may determine to be appropriate for the convenience of the Owner.

If the performance of all or any part of the work is, for any unreasonable period of time, suspended, delayed, or interrupted by an act of the Owner in administration of this Contract or by his failure to act within the times specified in this Contract (or if no time is specified, within a reasonable time), an adjustment shall be made for any increase in the cost of performance of this Contract (excluding profit) necessarily caused by such unreasonable suspension, delay or interruption, and the

Contract modified in writing accordingly. However, no adjustment shall be made under this Article for any suspension, delay or interruption to the extent.

1. that performance would have been so suspended, delayed, or interrupted by any other cause, including the fault or negligence of the Contractor, or
2. for which an equitable adjustment is provided or excluded under any other provision of this Contract.

No claim under this Article shall be allowed:

1. for any costs incurred more than twenty (20) days before the Contractor shall have notified the Owner in writing of the act or failure to act involved (but this requirement shall not apply as to a claim resulting from a suspension order), and
2. unless the claim, in an amount stated, is asserted in writing within sixty (60) days after the termination of such suspension, delay, or interruption, but not later than the date of final payment under this Contract.

157. TERMINATION FOR DEFAULT, DAMAGES FOR DELAY, TIME EXTENSIONS

If the Contractor refuses or fails to prosecute the work, or any separable part of the work, with such diligence as will insure its completion within the time specified in this Contract, or any extension thereof, or fails to complete said work within such time, or in the event of substantial failure to fulfill his obligations under this contract through no fault of the Owner, the Owner may, by written notice to the Contractor, terminate his right to proceed with the work or such part of the work as to which there has been delay. In such event the Owner may take over the work and prosecute the same to completion by contract or otherwise, and may take possession of and use in completing the work such materials, appliances, and plant as may be on the site of the work and necessary therefor. Whether or not the Contractor's right to proceed with the work is terminated, he and his Sureties shall be liable for any damage to the Owner resulting from his refusal or failure to complete the work within the specified time.

If the Contract provides for liquidated damages, and if the Owner terminates the Contractor's right to proceed, the resulting damage will consist of such liquidated damages until the work is completed or accepted.

The Contractor's right to proceed shall not be terminated nor the Contractor charged with resulting damage if:

1. The delay in the completion of the work arises from causes other than normal weather beyond the control and without the fault or negligence of the Contractor, including, but not restricted to, acts of God, acts of the public enemy, acts of the Owner in either its sovereign or contractual capacity, acts of another Contractor in the performance of a contract with the Owner, fires, floods, epidemics, quarantine restrictions, unusually severe weather, or delays of Subcontractors or suppliers at any tier arising from causes other than normal weather beyond the control and without the fault or negligence of both the Contractor and such Subcontractors or suppliers; and
2. The Contractor within ten (10) days from the beginning of any such delay (unless the Owner grants a further period of time before the date of final payment under the Contract), notifies the Owner in writing of the causes of delay. Any claim for a time extension shall be asserted in writing within sixty (60) days after the termination of the delay and include detailed and documented justification as well as a Time Impact Schedule Analysis. The Owner shall

ascertain the facts and the extent of the delay and extend the time for completing the work when, in his judgement, the findings of fact justify such an extension. His findings of fact shall be final and conclusive on the parties, subject only to appeal as Article "DISPUTES" of these GENERAL CONDITIONS provide.

If, after notice of termination of the Contractor's right to proceed under the provisions of this Article, it is determined for any reason that the Contractor was not in default under this Article, or that the delay was excusable under this Article, the rights and obligations of the parties shall be the same as if the Notice of Termination has been issued under Article "TERMINATION FOR CONVENIENCE" of these GENERAL CONDITIONS. The rights and remedies of the Owner provided in this Article are in addition to any other rights and remedies provided by law or under this Contract.

158. CLAIMS FOR ADDITIONAL TIME AND/OR COMPENSATION

When the Contractor deems additional time and/or compensation is or may be due him for work or costs not clearly covered in the Contract Documents, or not ordered by the Owner according to the provisions of Article "CHANGES", of these GENERAL CONDITIONS, the Contractor shall notify the Engineer in writing of his intention to make a claim for such additional time and/or compensation before he begins the work or otherwise incurs costs upon which he intends to base the claim. The Contractor shall clearly state which of the following listed articles of these GENERAL CONDITIONS the claim shall be based upon: Article "SUSPENSION FOR WORK"; Article "TERMINATION FOR DEFAULT, DAMAGES FOR DELAY, TIME EXTENSIONS," Article "TERMINATION FOR CONVENIENCE" Article "CHANGES"; or, Article "DIFFERING SITE CONDITIONS." Failure to comply in all respects to the notice and other filing provisions of these Articles may cause a rejection of the claim.

The Contractor shall also provide the Engineer with written information for keeping strict account of the actual costs of the work upon which the claim is based. Such costs shall be maintained in accordance with GENERAL CONDITIONS Article "PAYMENT FOR MODIFICATIONS" and "AUDIT: ACCESS TO RECORDS." If such notification or information is not provided by the Contractor, then he shall be deemed to have waived his right to claim for additional time and/or compensation. Such notice by the Contractor and the fact the Engineer has kept account of the cost shall not in any way be constructed as proving the validity of the claim. Claims for additional time and/or compensation shall be made in itemized detail based on a proper schedule analysis with the supporting documentation and submitted in writing in accordance with the Article of these GENERAL CONDITIONS under which the claim is being filed. The Engineer will carefully consider the claim and render a decision thereon in accordance with Article "DUTIES AND RESPONSIBILITIES OF THE ENGINEER" of these GENERAL CONDITIONS. If the Owner approves the claim, it will be paid for in accordance with Article "PAYMENT FOR MODIFICATIONS."

Claims for additional time and/or compensation for delays resulting from alterations or changes to the work that have been authorized by Modification Order will not be considered. All costs and time impacts for such altered or changed work shall have been included in the amount of compensation or time extension stipulated in the Modification Order prior to the signing of the Modification Order by the Owner and the Contractor.

159. TERMINATION FOR CONVENIENCE

- A. The Owner may terminate the performance of the work under this Contract in accordance with this Article in whole, or from time to time in part, whenever the Owner shall determine that such termination is in the best interest of the Owner. Any such termination shall be effected by delivery to the Contractor of a Notice of Termination specifying the extent to

which performance of the work under the Contract is terminated, and the date upon which such termination becomes effective.

- B. After receipt of a Notice of Termination and except as otherwise directed by the Owner, the Contractor shall:
1. Stop work under the contract on the date and to the extent specified in the Notice of Termination;
 2. Place no further orders or subcontracts for materials, services, or facilities except as necessary to complete the portion of the work under the Contract which is not terminated;
 3. Terminate all orders and subcontracts to the extent that they relate to the performance of the work terminated by the Notice of Termination;
 4. Assign to the Owner, in the manner, at the times, and to the extent directed by the Owner, all of the right, title, and interest of the Contractor under the orders and subcontracts so terminated. The Owner shall have the right, in his discretion, to settle or pay any or all claims arising out of the termination of such orders and subcontracts;
 5. Settle all outstanding liabilities and claims arising out of such termination of orders and Subcontractors, with the approval or ratification of the Owner to the extent he may require. His approval or ratification shall be final for all the purposes of this Article;
 6. Transfer title to the Owner, and deliver in the manner, at the times, and to the extent, if any, directed by the Owner, (i) the fabricated or unfabricated parts, work in process, completed work, supplies and other material produced as a part of, or acquired in connection with the performance of, the work terminated by the Notice of Termination, and (ii) the completed or partially completed Plans, drawings, information, and other property which, if the Contract had been completed would have been required to be furnished to the Owner.
 7. Use his best efforts to sell, in the manner, at the times to the extent, and at the price or prices that the Owner, directs or authorizes, any property of the types referred to in Paragraph B6 of this Article, but the Contractor (i) shall not be required to extend credit to any purchaser; and (ii) may acquire any such property under the conditions prescribed and at a price or prices approved by the Owner. The proceeds of any such transfer or disposition shall be applied in reduction of any payments to be made by the Owner to the Contractor under this Contract or shall otherwise be credited to the price or cost of the work covered by this Contract or paid in such other manner as the Owner may direct;
 8. Complete performance of such part of the work as shall not have been terminated by the Notice of Termination; and
 9. Take such action as may be necessary, or as the Owner may direct, for the protection and preservation of the property related to this Contract and in which the Owner has or may acquire an interest.
- C. After receipt of a Notice of Termination, the Contractor shall submit to the Owner his termination claim in the form and with the certification the Owner prescribes. Such claim

shall be submitted promptly but in no event later than one (1) year from the effective date of termination, unless one (1) or more extensions in writing are granted by the Owner upon request of the Contractor made in writing within such 1-year period or extension. If the Contractor fails to submit his termination claim within the time allowed, the Owner may determine, on the basis of information available to him, the amount, if any due to the Contractor because of termination. The Owner shall then pay to the Contractor the amount so determined.

- D. Subject to the provisions of Paragraph C, the Contractor and the Owner may agree upon the whole or any part of the amount or amounts to be paid to the Contractor because of the total or partial termination of work under this Article. The amount or amounts may include a reasonable allowance for profit on work done. However, such agreed amount or amounts, exclusive of settlement costs, shall not exceed the total Contract price as reduced by the amount of payment otherwise made and as further reduced by the Contract price of work not terminated. The contract shall be amended accordingly, and the Contractor shall be paid the agreed amount. Nothing in Paragraph E of this Article prescribing the amount to be paid to the Contractor in the event of failure of the Contractor and the Owner to agree upon the whole amount to be paid to the Contractor because of the termination under this Article, shall be deemed to limit, restrict, or otherwise determine or affect the amount or amounts which may be agreed upon to be paid to the Contractor pursuant to this Paragraph D.
- E. If the Contractor and the Owner fail to agree, as Paragraph D provides, on the whole amount to be paid to the Contractor because of the termination of work under this Article, the Owner shall determine, on the basis of information available to him, the amount, if any, due to the Contractor by reason of the termination and shall pay to the Contractor the amounts determined as follows:
1. For all Contract work performed before the effective date of the Notice of Termination, the total (without duplication of any times) of (i) the cost of such work; (ii) the cost of setting and paying claims arising out of the termination of work under subcontracts or orders as Paragraph B5 of this Article provides. This cost is exclusive of the amounts paid or payable on account of supplies of materials delivered or services furnished by the Subcontractor before the effective date of the Notice of Termination. These amounts shall be included in the cost on account of which payment is made under (i) above; and (iii) a sum, as profit on (i), above, that the Owner determines to be fair and reasonable. But, if it appears that the Contractor would have sustained a loss on the entire contract had it been completed, no profit shall be included or allowed under this subdivision (iii) and an appropriate adjustment shall be made reducing the amount of the settlement to reflect the indicated rate of loss; and
 2. The reasonable cost of the preservation and protection of property incurred under Paragraph B9 of this Article, and any other reasonable cost incidental to termination of work under this Contract. The total sum to be paid to the Contractor under Paragraph E1 of this Article shall not exceed the total sum to be paid to the Contractor under Paragraph E1 of this Article shall not exceed the total Contract price as reduced by the amount or payments otherwise made and as further reduced by the Contract price of the work not terminated. Except for the normal spoilage, and except to the extent that the Owner shall have otherwise expressly assumed the risk of loss, there shall be excluded from the amounts payable to the Contractor under Paragraph E1 above, the fair value, as determined by the Owner of property which is destroyed, lost stolen, or damaged, to the extent that it is undeliverable to the Owner, or to a buyer under Paragraph B7 of this Article.

- F. The Contractor shall have the right to dispute under Article "DISPUTES" of these GENERAL CONDITIONS from any determination the Owner makes under Paragraph C or E of this Article. But, if the Contractor has failed to submit his claim within the time provided in Paragraph C of this Article and has failed to request extension of such time, he shall have no such right to appeal. In any case where the Owner has determined the amount due under Paragraph C or Paragraph E of this Article, the Owner shall pay to the Contractor the following: (i) if there is no right of appeal hereunder or if no timely appeal has been taken, the amount so determined by the Owner or (ii) if a Disputes proceeding is initiated, the amount finally determined in such Disputes proceeding.
- G. In arriving at the amount due to the Contractor under this Article, there shall be deducted (i) all unliquidated advance or other payments on account theretofore made to the Contractor, applicable to the terminated portion of this contract, (ii) any claim which the Owner may have against the Contractor in connection with this Contract, and (iii) the agreed price for, or the proceeds of sale of, any materials, supplies or other things kept by the Contractor or sold, under the provisions of this Article, and not otherwise recovered by or credited to the Owner.
- H. If the termination hereunder be partial, before the settlement of the termination portion of this Contract, the Contractor may file with the Owner a request in writing for an equitable adjustment of the price or prices specified in the Contract related to the continued portion of the Contract the portion not terminated by the Notice of Termination). Such equitable adjustment as may be agreed upon shall be made in the price or prices. Nothing contained herein shall limit the right of the Owner and the Contractor for the completion of the continued portion of the Contract when the Contract does not contain an established Contract price for the continued portion.

160. OWNER'S USE OF PORTIONS OF THE WORK

The Owner at anytime may request the Contractor, in writing, to permit the Owner to use any part of the work which the Owner may require and which may be so used without significant interference with construction of the other parts of the work. Within a reasonable time thereafter, the Owner, the Contractor, and the Engineer shall make an inspection of that part of the work to determine its status of completion. If the Engineer does not consider that part of the work to determine its status of completion. If the Engineer does not consider that part of the work to be substantially complete, the Engineer will notify the Owner and the Contractor in writing, giving his reasons therefore. If the Engineer considers that part of the work to be substantially complete, the Engineer will execute and deliver to the Owner and the Contractor a Certificate of Substantial Completion as set forth in Article "SUBSTANTIAL COMPLETION DATE" of these GENERAL CONDITIONS and fixing the date of Substantial Completion as to that part of the work, attaching thereto a tentative list of items to be completed or corrected before final payment. Such tentative list shall not be considered as a complete listing of Contractor's responsibilities for meeting the requirements for final acceptance of the work. The tentative listing of uncompleted items shall include the time within which the Contractor shall complete the items listed therein. The Owner will allow the Contractor reasonable access to complete or correct items on the tentative list.

In lieu of the issuance of a Certificate of Substantial Completion, the Owner may occupy and operate a facility constituting part of the work, whether or not it is substantially complete, if such facility is functionally and separately usable; provided that prior to any such takeover, the Owner and the Contractor have agreed as to the division of responsibilities between the Owner and the Contractor for security, operation, safety, maintenance, correction period, heat, utilities, and insurance with respect to such facility.

Such use shall not be considered as final acceptance of any portion of the work, nor shall such use be considered as cause for an extension of the Contract completion time unless authorized by a Contract Modification by the Owner.

161. TIME OF COMPLETION

The Contractor shall complete all or any portion of the Project called for under the Contract in all parts and requirements within the time or times for completion of the Contract set forth in the Information for Bidders. All time limits stated in the Contract Documents are of the essence of the Contract.

When the Contract Time is on a working day basis, the Engineer will furnish the Contractor a weekly statement showing the number of days charged to the Contract for the preceding week and the number of days specified for Completion. The Contractor is allowed one (1) week in which to file a written protest setting forth in what respect said weekly statement is incorrect. Otherwise, the statement is deemed to have been accepted by the Contractor as correct.

When the Contract Time is on a calendar day basis, it shall consist of the number of calendar days stated in the Contract counting from the date set forth in the Notice to Proceed in accordance with GENERAL CONDITIONS Article "COMMENCEMENT OF WORK," including all Saturdays, Sundays, holidays, and non-work days.

When the Contract Time is a specified completion date, that is the date on which the Contract shall reach Completion.

162. LIQUIDATED DAMAGES OR ACTUAL DAMAGES FOR DELAY

A. GENERAL

Time is of the essence of this contract, and either, but not both, Liquidated Damages or Actual Damages for Delay will be assessed against the Contractor for failure to complete the work within the time(s) specified in these Contract Documents. The type of damages to be assessed for failure to complete the work on time is set forth in the Information for Bidders.

B. LIQUIDATED DAMAGES

Should the Contractor fail to complete the work, or any part thereof, in the time agreed upon in the Contract or within such extra time as may have been allowed for delay by extensions granted as provided in the Contract, the Contractor shall reimburse the Owner for the additional expense and damage for each calendar day, Sundays and legal holidays included, that the Contract remains uncompleted after the Contract completion date. It is agreed that the amount of such additional expense and damage incurred by reason of failure to complete the work is the actual cost to the Owner, which is estimated at a per-diem rate stipulated in the Information for Bidders. The said amounts are hereby agreed upon as liquidated damages for the loss to the Owner on account of expense due to the employment of Engineers, inspectors, and other employees after the expiration of the time of completion, and as applicable, expenses incurred by the Owner as a result of the impact of the Contractor on other Contractors under this project or other contracts, and on account of the value of the operation of the works dependent thereon. It is expressly understood and agreed that this amount is not to be considered in the nature of a penalty, but as liquidated damages, which have accrued against the Contractor. The Owner shall have the right to deduct such damages from any amount due, or that may become due the

Contractor, or the amount of such damages shall be due and collectible from the Contractor or his Surety.

C. ACTUAL DAMAGES FOR DELAY

Failure to meet the Contract Completion Date(s) by the Contractor will subject the Contractor to liability for all damages suffered by the Owner. Damages that might accrue to the Owner include, but are not limited to, the additional costs for project inspection, the Owner's project administration and overhead, the Engineer's project administration and overhead, loss of revenue from the completed facility, delay or impact damages from other Contractors on this Contract or other Contractors on the Contracts resulting from the delay, rental costs incurred by the Owner as a result of delay in completion of this Contract, value and use loss arising from this delay, and all legal costs associated with administration for this General Conditions or with any litigation arising out of this General Conditions. The Owner may, without prejudice to any other remedies that may be available, withhold from any monies due, or which may become due the Contractor, all damages sustained or which may be sustained in accordance with this Article. The rights and remedies of the Owner provided in this Article are in addition to any other remedies provided by law or under this Contract.

163. RESERVED

164. RESERVED

PROGRESS SCHEDULE

165. GENERAL

This work consist of the preparation and maintenance of a project control system using the Critical Path Method (CPM) of scheduling which shall be developed and used by the Contractor to demonstrate Contractor planning for the performance and progress of all activities, in accordance with this specification and contract documents.

By submitting a bid on the project, the Contractor is representing to the Owner that the project can be completed by the Required Completion Date and in accordance with all Project Milestone Dates, and that included in the Contract Price are any and all costs which may be incurred in order to meet all of the requirements of this Contract and to complete the Contract work by the Required Completion Date, and in accordance with all Project Milestone Dates.

At or prior to the pre-construction conference, the Contractor shall furnish, for approval, a progress schedule showing the order in which the Contractor proposes to prosecute the Work; the dates on which the various work stages, operations, and principal items of Work including procurement of materials and plant will begin; the quantity and kinds of equipment and character of the labor force; and the contemplated dates for completing the same. The progress schedule shall clearly outline the intended maintenance of traffic, the locations where temporary and permanent soil erosion and sediment control measures shall be installed, and such other information as required by the Contract documents or as deemed appropriate for the Project. The progress schedule shall give special consideration to sensitive areas such as wetlands, floodplains, waterways, and parklands to ensure that appropriate staging and seasonal constraints are considered in order to maximize the effectiveness of the soil erosion and sediment controls. The progress schedule shall also indicate any time frames when work is restricted in these sensitive areas as outlined in the permits issued by the regulatory agencies.

Construction operations shall not begin until the progress schedule has been approved. Once the progress schedule has been approved, the Contractor shall not deviate from it without first notifying the Engineer in writing. In scheduling and executing the Work, the following shall be considered:

- A. Staging - The Contractor shall schedule the Work using such procedures and staging as may be specified in the Contract Documents. Work designated as part of separate stages may be performed simultaneously where provided by the Contract Documents or where approved.

When the Contract Documents provide for staging or specific procedures, the Contractor may, prior to submitting a progress schedule, present for written approval of the Engineer, a detailed, written alternate staging plan or procedure which incorporates the requirements of the Owner. As a condition of the Engineer's reviewing the alternate staging plan or procedure, the Contractor agrees that it is not entitled to additional Contract Time or compensation arising from possible delays to construction due to the time spent in reviewing the Contractor's staging plan or procedure, regardless of whether the Owner accepts or rejects it. If such staging plan or procedure is approved in writing, the Contractor may then prepare a progress schedule consistent with the approval.

Bituminous paving operations shall be staged to progress up to the bottom of the surface course. The bituminous concrete surface course for the full width of the traveled way, shoulder, and auxiliary lanes shall be paved as a single stage of construction and as the final paving operation.

- B. Prosecution of the Work - The Contractor shall provide sufficient materials, equipment, and labor to guarantee the completion of the Project in accordance with the Contract Documents and within the time set forth under GENERAL CONDITIONS Article "TIME OF COMPLETION" and in the Information for Bidders.

Should the prosecution of the Work be discontinued by the Contractor for any reason, the Contractor shall notify the Engineer, in writing, prior to discontinuing work and at least 24 hours before resuming operations.

The Contractor shall arrange and prosecute the Work so that each successive construction operation at each location shall follow the preceding operation as closely as the requirements of the various types of construction permit.

The Engineer may revise stage construction and maintenance of traffic, if deemed necessary, due to unforeseen circumstances which may arise during construction.

Compensation for additional expense to the Contractor and allowance of additional time for completion of the Work shall be as set forth in a Change Order or Supplementary Agreement or in accordance with GENERAL CONDITIONS Articles "CLAIMS FOR ADDITIONAL TIME AND/OR COMPENSATION," "EXTENSION OF TIME", "PAYMENT FOR MODIFICATIONS", and "EXTENSION OF TIME".

When possible, the construction of subsurface structures adjacent to traffic shall be performed while traffic is being diverted from such areas. If traffic must be maintained in such areas, the Work shall be performed expeditiously in stages, as approved, and with minimum interference with traffic.

Subsurface structure excavation adjacent to traffic shall not remain open overnight unless adequately protected by approved safety devices.

The Contractor shall proceed with the Work of demolition of the various buildings that are identified with a demolition number as they become available for demolition. If any of the buildings that are to be demolished are not available for demolition at the time the Contractor begins Work on the Project, the Contractor shall temporarily defer its Work in the vicinity of the building and complete the Work when the building is available for demolition.

Operations adjacent to traffic shall be confined to only one (1) side of the traffic at any one (1) time unless otherwise specified in the Contract Documents.

Concrete curbs to be constructed adjacent to flexible base and surface courses shall be completed, cured, and backfilled before the flexible base and surface courses are constructed.

Underground structures for traffic signals, except for pressure detector installations, shall be constructed prior to completion of the intersecting road.

- C. Intent, Responsibility, and Time - Scheduling of construction is the responsibility of the Contractor. Therefore, it is the Contractor's responsibility to determine the most feasible order of Work commensurate with the Contractor's abilities and the Contract Documents. The requirement for the progress schedule is included to ensure adequate planning and execution of the Work, to assist the Engineer in appraising the Contractor's compliance with the Contract Documents, and to evaluate progress of the Work. The progress schedule will be used for determining extensions or reductions of Contract Time pursuant to GENERAL CONDITIONS Articles "CLAIMS FOR ADDITIONAL TIME AND/OR COMPENSATION" and "EXTENSION OF TIME".

It is not intended that the Engineer, by approving the progress schedule, agrees that it is reasonable in all respects or that following the progress schedule can result in timely completion of the Project. The progress schedule is not a part of the Contract.

If, in the preparation of the progress schedule, the Contractor projects a completion date that is different than that specified under GENERAL CONDITIONS "TIME OF COMPLETION," the progress schedule in no way voids the date set by the Contract. The date as specified in that Article governs. Where the progress schedule reflects a completion date that is earlier than that specified as the Contract Time, the Engineer may approve the schedule with the Contractor specifically understanding that no claim for additional Contract Time or compensation shall be brought against the Owner as the result of failure to complete the Work by the earlier date shown on the progress schedule.

- D. Acceleration and Default - If, in the opinion of the Engineer, the Contractor falls behind his progress schedule, and cannot complete the Work within the time prescribed under GENERAL CONDITIONS Article "TIME OF COMPLETION", as modified pursuant to GENERAL CONDITIONS Articles "CLAIMS FOR ADDITIONAL TIME AND/OR COMPENSATION", and "EXTENSION OF TIME", the Contractor shall take such steps as may be necessary to improve his progress. The Engineer may require the Contractor to increase the number of shifts, begin overtime operations, work extra days including weekends and holidays, or

supplement his construction plant and to submit for approval such supplementary schedule or schedules, as may be deemed necessary to demonstrate the manner in which the agreed rate of progress shall be regained, all at no cost to the Owner.

Failure of the Contractor to comply with the requirements of the Engineer under this Subheading is grounds for the determination that the Contractor is not prosecuting the Work with such diligence as to ensure Completion within the time specified. Upon such determination, the Engineer may terminate the Contractor's right to proceed with the Work or any separable part thereof in accordance with GENERAL CONDITIONS Article "TERMINATION FOR DEFAULT, DAMAGES FOR DELAY, TIME EXTENSIONS."

The following definitions apply:

- (1) Critical Activities: Activities that control the total duration of a Project, by forming a chain making up the longest sum of durations in a Project. This chain of critical activities forms the critical path of a Project.
- (2) Float: The length of time the start or finish of an activity can be delayed without delaying the Project Milestone Date(s). Float is a shared commodity.
- (3) Milestone Dates: Contractual Milestone Dates as defined in the Information to Bidders section titled "Time of Completion."
- (4) Lag: The delay in number of time units, between an activity and its successor or predecessor. The delay period is from the start or finish of an activity to the start or finish of its successor or predecessor. Lag units can be positive or negative values.

The Contractor shall assign a person, with decision-making Owner, responsible to manage this work. Refer to the Milestone Dates referenced in the Information for Bidders section of the Contract.

166. PROCEDURES

A. "Scheduling Conference"

1. Attend a Scheduling Conference with the Engineer within seven (7) calendar days after the Award. The purpose of the Scheduling Conference is to review this specification.
2. At the conference, submit a list of all Required Completion Dates and Milestone Dates, as specified in this Contract. Be prepared to discuss concepts and the logic to be used in sequencing work activities for development of the Schedule.
3. In addition, designate a representative to serve as the CPM Scheduler and submit that individual's credentials for acceptance by the Engineer, as described in GENERAL CONDITIONS Article entitled PROCEDURES, Paragraph H of this specification.

B. "Preliminary Ninety-Day CPM Schedule"

Within fourteen (14) calendar days after the Notice of Award of the Contract, or fourteen (14) calendar days prior to the Pre-construction Conference (whichever occurs earlier), submit a "Preliminary Ninety-Day CPM Schedule" which itemizes the work and defines the Contractor's plan for the first ninety (90) days of Contract Time. This "Preliminary Ninety-Day CPM Schedule" will provide detail for the first ninety (90) days of the Contract Time, in full accordance with all requirements of this GENERAL CONDITIONS, PROGRESS

SCHEDULE, as well as summary logic for the remainder of the Contract Time. The use of lag lead times in the Preliminary Ninety-Day Schedule and the CPM Schedule is not permitted. All relationships shown are to be Finish to Start relationships. No work on the project will be permitted by the Contractor or any Subcontractors until the Engineer receives, reviews, issues comments and accepts this "Preliminary Ninety-Day CPM Schedule." Maintain and submit monthly a Ninety-Day Look Ahead Schedule until the "CPM Schedule" is accepted by the Engineer. Additionally, no extension of Contract Time will be allowed for any delays associated with the Contractor's preparation and the Engineer's review and acceptance of the "Preliminary Ninety-Day CPM Schedule." Until the "CPM Schedule" for the Contract is accepted, the Ninety-Day Schedule will be the basis for evaluating progress and coordinating the work.

C. "CPM Schedule"

Within fourteen (14) calendar days after Notice to Proceed with the Contract, prepare, complete, and submit to the Engineer for review, a Composite CPM Schedule, incorporating the schedules for all Subcontractors, interfaces with Contractors on adjacent Contracts, utilities, and railroads performing work in full accordance with this Contract. As such, it will comply fully with all Contract Provisions including, but not limited to, the requirements regarding contract time, milestones, coordination and cooperation with utility companies, governmental agencies, maintenance and protection of traffic, erosion and sedimentation control, construction noise restrictions and the requirements specified in Contract Provisions. Current estimate payments will not be released until the schedule is submitted in the format described in this section.

Acceptance of the Schedule does not approve the Contractor's estimate of resources (labor and equipment) or production rates. The Contractor is responsible to perform all work in accordance with the Schedule including all accepted revisions. However, nothing in the Schedule shall supersede the Contract Time requirements including the Required Completion Date, all Project Milestone Dates, and all coordination and cooperation requirements of the Contract.

D. The "CPM Schedule" will conform to the following:

1. The Schedule will be prepared as a Critical Path Method (CPM) schedule utilizing the Precedence Diagramming Method (PDM). The Schedule shall be at level of detail to be useful to field forces and to assure adequate planning, execution, monitoring, and recording of the progress of the work. Activity durations shall be limited to a maximum duration of fifteen (15) working days, as measured in accordance with the calendar applicable to that activity.
2. The Schedule shall be developed and used by the Contractor to: (a) schedule all work activities, (b) provide necessary and required coordination and cooperation logic between Contractors and utilities, (c) show all interdependent work activities, (d) phase construction, (e) stage construction, (f) provide traffic restrictions, (g) provide resource needs, (h) indicate time estimates for transmittal reviews for Contractor designs, shop drawings and other submissions, (is) provide all other controlling and subsequent operations. In addition to construction activities, the Contractor should include on the Schedule as a minimum, the procurement, fabrication and delivery of critical or special materials and equipment, and indicate restraints or relationships, means, method, sequences, and construction logic that may be required by the work, and that may be required by the Engineer. The Contractor's CPM Schedule shall integrate and meet the Milestone Dates as provided in the Contract.

3. The Engineer will be utilizing the most current version of Project Planner by Primavera for Windows or Primavera Suretrak. The Contractor may use one (1) of the following current Windows based versions of the approved scheduling software listed below, when approved by the Engineer. All data shall be submitted on disk(s) that are compatible with the Engineer's system and those disks will be provided to the Engineer by the Contractor.

Approved Scheduling software includes:

Project Planner by Primavera
Suretrak by Primavera
Aldegraf Scheduling System by Aldegraf System, Inc.

Alternative software scheduling may be utilized if approved by the Engineer. Also, the Contractor is to provide training to the Engineer as recommended by the manufacturer for approved alternate software packages, if applicable.

- E. Adjust Contract Time only in accordance with the requirements of Contract, GENERAL CONDITIONS and the Article entitled EXTENSION OF TIME of this Element.
- F. Progress Reports will be required bi-weekly. They shall be subject to comments from the Engineer.
- G. Requirements for initial submittal, review, and updating the CPM Schedule are included in GENERAL CONDITIONS Article of this Element entitled SUBMITTALS. Use the CPM Schedule for planning, organizing, and directing the Contractor's work and for reporting progress.
- H. Designate an individual (or Subconsultant), to be available to the Engineer on an as-needed basis during the duration of the project, as the CPM Scheduler. Submit the CPM Scheduler's experience and credentials to the Engineer for review and acceptance prior to proceeding with any scheduling work under this Contract. Prior experience with resource-loaded CPM scheduling, knowledge of the specific scheduling software being used, and knowledge and experience shall be to administer the elements of this Project Schedule specification section. The Owner reserves the right to rescind such acceptance at any time during the Contract and to require the Contractor to provide a qualified replacement. The delegation of the CPM Scheduler's duties is not permitted, however, the Contractor may engage the services of qualified consultant to advise and provide staff assistance to the Construction Coordinator, if approved by the Owner.
- I. Comply with all requirements of the Contract regarding coordination, cooperation, contract, and schedule.

167. CONTENT AND PROJECT SCHEDULE

- A. The CPM Schedule shall consist of a pure logic CPM network diagram, activity sorts, printed reports, and digital data on disks, all of which will include the Required Completion Date and Milestone Dates. This shall include, but is not limited to, activities describing all work, the sequence of work, and all requirements of coordination and cooperation between Contractors, Subcontractors, Contractors on adjacent Contracts, Owner's work, utilities, governmental agencies, and other parties involved with the Work.

- B. Diagrams shall show the order and interdependence of activities and the sequences in which the Work is to be accomplished. The basic concept of the network analysis diagram shall be followed to show how the start or finish of a given activity is dependent on other activities. Predecessor and successor activity restraints must be documented and provided in all reports to the Owner. The use of leads and lags in the Schedule and Contractor imposed constraint dates are prohibited.
- C. The CPM Schedule shall be prepared in such a manner that the Contractor's Work sequence shall be optimized between early start and late start dates.
- D. Detailed network activities shall include, in addition to construction activities, the submittal of samples, product data, shop drawings, fabrication, procurement and delivery of critical materials and equipment, and the manufacture, installation, and testing of special materials and equipment. Allow sufficient time for review, resubmittal, and/or resubmittal reviews, as required. Allow additional time for review by entities other than the Owner and its design consultants. Allow fourteen (14) calendar days for the review by the Engineer. Obtain concurrence of the Engineer for the duration in the Schedule for submission review activities by other entities. Owner activities, which affect progress, and milestone dates for completion of parts of the work, shall also be shown in accordance with Contract requirements.
- E. The CPM Schedule Logic Diagram shall be based on areas of work and should show a continuous flow of activities from left to right. The CPM Schedule Diagram shall be sufficiently detailed to accurately depict the work. Activity numbers, activity descriptions, and activity duration in working days shall be shown on the diagram for each activity. The CPM Schedule (both logic diagrams and activity sorts and reports) should be coded by area, pay item, stage, responsibility, type of activity, and other relevant features through the use of activity codes. The following information shall be furnished for each activity:
1. Activity number
 2. Activity description
 3. Estimated duration of activity, in working days
 4. Preceding and succeeding activity numbers

In conjunction with the CPM Schedule Diagram, provide the following information for each activity in the CPM Schedule:

1. Remaining duration of activity, in working days
2. Earliest start date, by calendar date
3. Earliest finish date, by calendar date
4. Actual start date, by calendar date
5. Actual finish date, by calendar date
6. Latest start date, by calendar date
7. Latest finish date, by calendar date
8. Total float
9. Estimated man-hours and shifts by classification
10. Estimated major equipment usage
11. Estimated cost
12. Estimated quantities of work

Be responsible for assuring that Subcontractor work and Contractor work is included in the network diagram, that work sequences are logical, and that the diagram shows a coordinated plan of work between the Contractor and Subcontractors and between Subcontractors.

Contractor imposed dates in the construction schedule do not bind the Owner. Only the Required Completion Date, and Milestone Completion Dates, and any contractually specified sequences shall be binding on the Owner in accordance with the Contract documents.

Consider, and make appropriate schedule and operational allowances, for weather conditions and the influence of high or low ambient temperatures on the completion of all Contract Work within the allotted Contract Time. The Owner assumes no responsibility for the impact of weather on the Contractor's Schedule.

Provide workday calendars, which address the specified and working requirements, which affect the project. Examples of calendars include a normal five (5) day week, weekend only work, holiday restrictions, traffic restrictions, shift requirements, duration of shifts, and seasonal restrictions.

Provide and document the correlation between each schedule activity and its corresponding pay item(s).

Clearly identify in the CPM Schedule network-diagram the activities illustrating accomplishment within the time for completion set forth in the Contract. Should the Schedule indicate an earlier completion than the time for completion set forth in the Contract, the difference between such an Early Completion Date and the Required Completion Date or any Milestone Date shall be defined as float. Show the float for the various activities on the computer-product printout. Define any float developed between an early completion point (i.e., prior to the contractual completion) and the contractual completion date as part of the project float. Float is the measure of an activity's ability to have its performance extended without affecting the critical path. Float is a commodity available to the Contractor and the Owner.

168. SCHEDULE REVIEW MEETINGS

Attend all Schedule Review Meetings on dates and times specified by the Engineer. Attendees at Schedule Review Meeting must include the CPM Scheduler, and, if requested by the Engineer, the Project Manager, Superintendent, and/or representatives from active, key Subcontractors. Schedule Review Meetings will be held bi-weekly. The attendees of the meeting shall review actual progress, planned progress for the next period, Change Order and any schedule changes since the previous update(s). Attendance is mandatory. Updated Progress Reports must be submitted to the Engineer for review in accordance with GENERAL CONDITIONS Article "SUBMITTALS."

Submit an updated disk and Progress Report three (3) days prior to every bi-weekly Progress Meeting. In the update for the Contractor, provide revised information based on progress to date. The data date will be equal to one (1) week prior to the Progress Meeting date. This information will be updated by the Contractor as described in GENERAL CONDITIONS Article titled UPDATING.

Incorporate all comments discussed at the Schedule Review Meeting into the next scheduled Progress Report submission.

169. UPDATING

The information described in GENERAL CONDITIONS paragraph E of the Article titled CONTENT AND PROJECT SCHEDULE shall be updated as follows. The activity percent complete and remaining duration are to be updated independently of each other.

Updates and Progress Reports shall be submitted bi-weekly. The Update shall provide revised information based on progress to date and logic changes incurred since the previous update. Bi-weekly updated Progress Reports shall show the activities completed during the reporting period. The Reports shall state the percentage of each activity the Contractor completed as of the reporting date, and the progress along each critical path in terms of days ahead or behind the latest allowable dates. The Report shall include a narrative description which includes, but is not limited to, a description of work activities completed, activities completed during this period, activities that are behind schedule, anticipated problems, delaying factors, their impact, and a description of corrective construction actions taken or contemplated. Changed work as a result of Change Orders shall be addressed in bi-weekly Progress Reports in full accordance with the Contract requirements. Change Orders shall be incorporated into the Schedule.

The Schedule will not be revised as long as the Contractor actually performs the work in the order and sequence shown on the Schedule. If the Contractor changes the order of his operations on the Project so that the Schedule no longer indicates reasonable logic for completing the Contract, the Contractor shall submit Schedule revisions to the Engineer for review, comment and acceptance. Comply with all comments issued by the Engineer as a result of such review without additional cost to Owner. Such a revision shall comply with all Contract Time requirements.

If the Owner revises the work and affects the sequence of operations or duration of time on work activities, the Schedule shall be revised promptly by the Contractor in accordance with the contract documents by adding, deleting or revising activities and/or changing restraints on the Schedule to indicate the Contractor's current plans for completing the work as revised. Submit such changes for the Engineer's review, comment and acceptance, as described above in this Article of the GENERAL CONDITIONS.

Immediately notify the Engineer if a problem arises requiring direction to the Contractor by the Engineer. Identify in writing all changes in activity durations or planned work sequences that impact the Required Completion Date or any Milestone Date and are caused by differing site conditions, changes in quantities, or alterations of the construction drawings. The Contractor shall completely identify the problem and describe "Who, What, When, Where, Why and How" the problem impacts the Schedule. The Engineer will verify the problem in accordance with the Contract and provide direction to the Contractor. Submit a schedule report to the Engineer, outlining the effect that changes, or work directed by the Engineer might have on the Schedule, within seven (7) calendar days after receiving the change or direction. In cases where a Change Order is required, the Contractor shall revise the Schedule to accommodate the proposed change, the preparation of cost or credit estimates, issuance of the Change Order, negotiations, review and approval of samples, drawings, procurement of materials and the performance or deletion of work. Submit proposed Schedule revisions to the engineer for review, comment and acceptance.

Provide a Two (2) Week Look Ahead Schedule Bar Chart produced from the Schedule software on a weekly basis.

170. SUBMITTALS

Submit the Preliminary Ninety-Day CPM Schedule in accordance with the times stated in Article of the GENERAL CONDITIONS entitled PROCEDURES. Provide all information specified in the CONTENT AND PROJECT SCHEDULE of the GENERAL CONDITIONS for the detailed ninety-day portion of the Schedule. The Engineer will review and, if necessary, offer comments. Comply with the Engineer's comments. Update the Preliminary Ninety-Day CPM in accordance with Article titled UPDATING.

Submit the CPM Schedule to the Engineer for review within fourteen (14) days after Notice to Proceed. The initial submission must be made in digital format (3 ½ inch disk) and must be accompanied by three (3) sets of the following hard copy documents:

Pure Logic and Time Scaled Logic Diagram and Bar Chart Tabular Reports, sorted as follows:

- by Activity Number
- by Responsibility and Activity Number
- by Total Float, Early Start
- by Detailed Predecessor – Successor Analysis
- by up to four (4) additional categories which may be requested by the Engineer

The Contractor's Schedule shall consist of the Schedule Diagram and the Tabular Reports. It shall include all comments on the Preliminary Schedule, and the schedules required from other Subcontractors, interfaces with the Contractors on adjacent Contracts, utilities, railroads, and governmental agencies. This Schedule shall become the original Schedule of record for planning, organizing and directing the work and for reporting progress. The Contractor's CPM Schedule and Tabular Reports shall be updated as the need arises and determined by the Engineer, but not less often than bi-weekly. Typically, updates shall be required whenever the work is affected by Change Orders, deviations from previously submitted schedules and development of schedules by Subcontractors, Contractors on adjacent Contracts, utilities, railroads, and governmental agencies. The updates are to be submitted with the Tabular Reports, or as directed by the Engineer in accordance with the Article entitled SCHEDULE REVIEW MEETINGS.

All data required by the Article of the GENERAL CONDITIONS titled CONTENT AND PROJECT SCHEDULES, must be included in this submission.

Submit the Two (2) Week Look Ahead Schedule required in Article titled UPDATING to the Engineer two (2) calendar days prior to the scheduled Progress Meeting.

Failure by the Contractor to submit a project schedule or any required revisions or updates thereto within the time limits specified, shall be sufficient cause for the Engineer to withhold processing of current estimates until such delinquent submittal is made. Should the Contractor fail to submit the schedule information within twenty-eight (28) calendar days, after the project schedule update, material breach of Contract shall result from failure to provide the Engineer with the required schedules and failure to implement such schedules immediately. Consider this material breach of Contract to be the Contractor's default of Contract, and as such, be subject to the provision GENERAL CONDITIONS Article "TERMINATION FOR DEFAULT, DAMAGES FOR DELAY, TIME EXTENSIONS."

The Engineer's review of a schedule shall in no way waive the requirements of this Contract nor shall it excuse the Contractor of any obligations under this Contract. Should a situation occur, such that an activity required by the Contract is not accurately depicted in the schedule, and its insertion impacts the project completion date, the Contractor must take the necessary action to recover the lost time. These efforts will be made at no additional cost to the Owner.

171. RECOVERY SCHEDULE

The Owner reserves the right to require a Recovery Schedule and implementation of such a Recovery Schedule. All statements regarding progress shall be subject to verification by the Engineer. Revise such statements if necessary, to reflect any changes identified by the Engineer. All changes identified in a schedule revision shall be reviewed by the Engineer and shall be subject to acceptance or rejection on the basis of compliance with the Contract and the GENERAL

CONDITIONS. Accept and comply with all comments issued by the Engineer as a result of any review of a schedule.

If the Engineer deems that the Contractor has fallen ten (10) working days behind the project schedule (as measured in relation to the Required Completion Date and the Milestone Dates) upon the Engineer's written request, submit a written and documented Recovery Schedule. This Schedule must be submitted within seven (7) calendar days of the date of the Engineer's request or within such other period as the Engineer may specify in writing. Implement the Recovery Schedule with no additional cost to the Owner and provide for completion of the work in accordance with the Required Completion Date and the Milestone Dates, without a time extension. Document in the Recovery Schedule all additional resources, including materials, equipment and labor, and modifications of operations which will be provided so as to meet the Recovery Schedule while maintaining construction restrictions listed in the Contract unless approved otherwise by the Engineer. Provide all such additional resources and modifications of operations without additional cost to the Owner. Such additional resources and modifications shall include but not be limited to:

1. Required overtime for the Contractor's personnel.
2. Increased construction manpower in such quantities as will substantially eliminate the backlog of work and put the project back on schedule.
3. Increased number of shifts per working day, working days per week, or the amount of construction equipment, or any combination of the foregoing which will put the project back on schedule.
4. Rescheduled activities to achieve the maximum practical concurrence of accomplishment of activities to put the project back on schedule.

Failure to provide the Engineer with the required Recovery Schedules and failure to implement such schedules within fourteen (14) calendar days of the Engineer's request shall be considered noncompliance by the Contractor in accordance with the Article titled SUBMITTALS. Continued failure to provide and implement a required Recovery Schedule for an additional fourteen (14) calendar days shall be the Contractor's default of Contract and, as such, shall be subject to the provision of GENERAL CONDITIONS Article "TERMINATION FOR DEFAULT, DAMAGES FOR DELAY, TIME EXTENSION."

172. EXTENSION OF TIME

The Owner shall have the right, at its discretion, by resolution to extend the time for completion of the Work beyond the time stated in this Contract (or as modified by any Change Order, Contract Modification, or Supplemental Agreement thereto), and may grant such an extension if the Contractor shall be actually and necessarily delayed by reason of any labor strike not caused, instituted, or provoked by the Contractor or any Subcontractor, agent or representative of the Contractor; by an injunction or interference of any public Owner; by Suspension of Work by the Owner; by any order, rule or regulation of any federal agency; or by any other cause deemed sufficient to the Owner, and not caused in whole or in part by the Contractor or any of his Subcontractors. Any extension of time shall be for the actual amount of such delay in such case. Such extension may not be allowed unless the Contractor has taken reasonable precautions to prevent such delays. During the occurrence of the cause of delay, within ten (10) calendar days after the commencement thereof, the Contractor shall present in writing to the Chief Engineer and Engineer a detailed claim therefore. Such written claim shall describe the circumstances of the delay. Furthermore, the information provided by such written claim shall be updated in writing, within thirty (30) calendar days after the end of the delay, and shall further specify the number of days actually delayed. Failure to submit both the initial and revised claims required by this Article will be sufficient cause for denying the requested time extensions. The extension of time granted under this Article shall not be the basis for additional compensation for any of the Contractor's costs incurred during the time of delay.

A. Extension of Total Contract Time.

Extension to the Total Contract Time will only be considered for actual, necessary, and justifiable delays impacting the actual critical path. Be responsible for any delays caused by failing to start work activities on the early start dates, inadequate or insufficient application of resources, or inability to complete the work within the Total Contract Time due to Contractor's approach to the work. Such delays shall not form the basis of any extension of time.

The Owner reserves the right, in its best interest, to negotiate the cost required to complete the Milestone work in accordance with the schedule dates, and not extend the Total Contract Time when justifiable delays are encountered.

In requesting an extension of time, furnish as part of the updated written claim specified in Article titled EXTENSION OF TIME, justification and supporting documentation as the Engineer deems necessary to determine whether the Contractor is entitled to an extension of time under the provisions of the Contract. This documentation shall include, but not be limited to, a schedule report illustrating the impact and net effect of the alleged delay on the critical path, diaries, timesheets and correspondence.

After a receipt of request for an extension of time the Engineer will make a decision based on facts and findings. Extensions of time will only be granted for justifiable delays, including those enumerated in the Article entitled EXTENSION OF TIME, when accepted, in writing, by the Engineer, as applied to the actual critical path of the project.

As specified in this Article, time extension requests accepted by the Engineer will result in extensions of time granted by the Owner upon completion of the work. Upon written notification of acceptance by the Engineer, the Owner will concurrently issue acknowledgement of entitlement to an extension of time. Unless stated otherwise therewith, submit a revised schedule incorporating the revised Contract Time and unless agreed otherwise, the Owner will not be responsible for any additional costs incurred as a result of work accelerated by the Contractor.

B. Adjustment of Interim Milestone Dates

Adjustment of Interim Milestone Dates will only be considered for justifiable delays involving the critical path and impact on Interim Milestone Dates by exceeding the positive float on the accepted Schedule. The Contractor shall be responsible for any delays caused by failing to start work activities on the early start dates, lack of continuous effort, inadequate planning and coordination of the work, inadequate or insufficient application of resources, or inability to meet the Interim Milestone due to Contractor's approach to the work. Such delays shall not form the basis of an extension of time to any of the Interim Milestone Dates. No adjustment of Interim Milestone Dates will be considered if such adjustment impacts the Total Contract Time, unless in addition to meeting the requirements of this Paragraph B, the requirements of Paragraph A, the Article titled Extensions of Total Contract Time, are also met.

The Owner reserves the right, in its best interest, to negotiate the cost required to complete the Interim Milestone work in accordance with the schedule dates, and not extend any Interim Milestone dates or the Contract Completion Date when justifiable delays are encountered.

In requesting an extension on listed elements or activities of an Interim Milestone Date, furnish justification and supporting documentation as the Engineer deems necessary to determine whether the Contractor is entitled to additional Interim Milestone Completion Time under the provisions of the Contract.

Submit, in writing, to the Engineer each request for change in any Interim Milestone Date within ten (10) calendar days after the beginning of the condition for which a time extension is requested.

After receipt of request for time extension to an Interim Milestone Date, the Engineer will make a decision based on facts and findings and will advise the Contractor of the approval or rejection of the Interim Milestone extension request, in writing. The Engineer's decision on the Interim Milestone extension request will be final.

Interim Milestone Time Extension will be granted for justifiable delays when accepted by the Engineer, on the actual critical path to that Interim Milestone.

C. Adjustment of Project Milestone Dates by Contract Modification

The EXTENSION OF TIME Article, Paragraphs A and B notwithstanding, extensions of time may be granted by Change Orders and/or Contract Modifications as defined in GENERAL CONDITIONS Article "CHANGES." The Milestone Dates will be adjusted only if upon the incorporation of activities for the work defined in the Change Order into the accepted Schedule, these activities impact the critical path by exceeding the projected milestone completion date at the start of the delay.

The Change Order procedure is modified as follows: the Contractor will be issued a draft Change Order for review. Within five (5) days, submit for review by the Engineer a schedule report incorporating all elements of the proposed Change Order, and its effect, if any, on the milestone dates. Upon acceptance of the report, the Contractor will be issued the Change Order indicating any additions or reductions to the Contract Time, which justifiably impacts the Milestone's critical path.

The Owner reserves the right, in its best interest, to negotiate the cost required to complete the work defined in the Change Order within the Project Milestone Dates, when that Change Order work justifiably impacts the Milestone's critical path.

173. DRAWINGS

The Contractor and Engineer shall maintain and monitor separate submission logs of all shop/work drawings, Contractor design drawings, and other drawing submissions affecting the work. In addition, the Contractor shall submit a copy of the transmittal for each submitted drawing to the Engineer. The Contractor and Engineer shall enter these submittal transactions into their respective submission logs.

In order to effectively use the submission log, include as a minimum the following information for each drawing and transmittal submitted, unless otherwise approved:

Project Name
Section Name
Owner Contract Number
Contractor
Engineer
Contractor's Shop Drawing Number

Submittal Number (1st submission, 2nd submission, etc.)
Specification Section
Item Number(s) Associated with the Submission
Shop Drawing Description
Date of Contractor's Submittal
The Schedule activity affected by the drawings

If the Contractor's drawing and/or his transmittal does not have this information, the drawing and/or its transmittal will be returned without review. Incomplete drawings, as determined by the reviewing party, will also be returned marked "Incomplete." The Contractor shall be responsible for any delays caused by incomplete drawing submissions.

After a drawing has been submitted once and has been reviewed, except as required to satisfy the review comments, do not add new information or details to that same drawing without the approval of the Engineer.

174. SUBMISSION LOG

The purpose of the submission log is to schedule and monitor the date of each shop/work drawing submittal, Contractor's designs and all other submissions required under this Contract, and the length of times for the Engineer's review, the number of times a submittal required resubmission by the Contractor and length of time taken by the Contractor to make re-submissions.

Submit an initial itemized submission log, together with Ninety (90) Day Work Plan, within fifteen (15) calendar days of the Notice of Award of the Contract or prior to the Pre-construction Conference, whichever occurs earlier. Submit a complete itemized submission log for the remainder of the Contract, together with the Detailed Construction Schedule, within forty-five (45) calendar days of the actual Notice to Proceed date. The itemized submission log shall conform to the Schedule and include all submittals required under this Contract.

Submittals shall be prioritized and shall be scheduled to allow the specified time for review. If the Engineer determines the number of concurrent submissions scheduled for review and acceptance is excessive, allow an additional amount of time for review that is acceptable to the Engineer.

The Submission log shall include the items listed in Section 10 of this specification plus the following information:

Date of Engineer's Reply to Contractor's Submittal
Action by the Engineer
Number of Calendar Days the Engineer has an Outstanding Drawing

The submittal date of each submission shall be incorporated into Schedule. Make submissions at least fourteen (14) calendar days prior to the date the Contractor needs the information for purchasing or fabricating material, equipment, etc. to allow for a minimum of fourteen (14) calendar days for in-house review by the reviewing party unless specified otherwise. This fourteen (14) calendar days period begins when the Engineer acknowledges receipt of the submission and ends when the Contractor is notified the review is complete.

Be responsible for all time required for re-submissions required to conform with the conditions set forth in this specification.

175. MEASUREMENT AND PAYMENT

Construction Schedule – Incidental

Payment for the construction schedule will be incidental to the Contract Unit Price bid for each and every item in the Contract. All costs for furnishing and updating the progress schedule shall be included in the prices bid for the various Pay Items scheduled in the Proposal.

176. RESERVED

177. RESERVED

PAYMENT

178. PAYMENT FOR MODIFICATIONS

Payment to the Contractor, or credit to the Owner for any modification to the work under the Contract covered by all Modification Orders shall be determined by the methods set forth herein:

A. UNIT PRICES

Unit prices stipulated in the Bid or provided by the Contractor in the Bid breakdown shall be utilized, where they are applicable and determined reasonable by the Owner. In the event that the Contract Modification results in a change in the original quantity by more than a twenty-five percent (25%) variation to Major Pay Items occurs, the Owner or the Contractor may in writing request a renegotiated unit price for the work in excess of 125%.

Major Pay Items are any Items having an original contract value equal to or in excess of 10 percent of the ORIGINAL Total Contract Price or 20 percent of the ORIGINAL Total Price for Port Improvement Program projects. The original contract value of a Pay Item equals the per unit price bid for said Pay Item multiplied by the estimated quantity of such item contained in the Proposal Form. All other Pay Items shall be considered Minor Pay Items. Minor Pay Items are not eligible for any adjustment in unit price regardless of how much the total quantity varies from the quantity contained in the Proposal.

When the Owner or the Contractor requests a renegotiated unit price for the work in excess of 125 percent of the work for Major Pay Items, the Contractor shall furnish a breakdown of the cost satisfactory to the Owner for review, for the proposed adjusted unit price, in accordance with C through L below. The basis for the adjustment will be agreed upon prior to the performance of the work. If the basis cannot be agreed upon, the work will be paid on a Force Account Payment basis as specified in C through L below.

When a Major Item experiences a decrease to below 75% of the original contract quantity, the actual quantity below the 75% of the approximate quantity may be paid at an adjusted price, as agreed upon with the Contractor and approved by the Owner; however, total compensation will not exceed the contract item's original value. Item value is defined as the original estimated contract quantity contained in the Proposal Form multiplied by the per unit price bid. The Contractor shall furnish a breakdown of the cost satisfactory to the Owner for review, for the proposed adjusted unit price, in accordance with C through L below. The basis for the adjustment will be agreed upon prior to the performance of the work. If the basis cannot be agreed upon, the work will be paid on a Force Account Payment basis as specified in C through L below.

Where Contract Modifications are determined on the basis of unit prices stipulated in the Bid or provided by the Contractor in the Bid Breakdown, that unit price shall constitute the total equitable adjustment including all overhead and profit due for the modification and no

further costs shall be owed under the contract for delay or impact to the unchanged portions of the Contract, or for any other reason.

A unit price for Extra Work shall be mutually determined by the Contractor and the Owner. The Contractor shall furnish a breakdown of the cost satisfactory to the Owner for approval, of the proposed unit price, in accordance with C through L below. The basis for the adjustment will be agreed upon prior to the performance of the work. If the basis cannot be agreed upon, the work will be paid on a Force Account Payment as specified in C through L below.

B. LUMP SUM

Lump Sum prices stipulated in the Bid or provided by the Contractor in the Bid breakdown shall be utilized, where they are applicable and determined reasonable by the Owner. The original contract price of a lump sum item may be adjusted only when the approximate quantities of a component items are designated on component item schedules incorporated in the bid proposal and the original component quantity variation is more than twenty-five percent (25%) for the component items of Major Pay Items. The Owner or the Contractor may in writing request a renegotiated unit price for component items.

Major Pay Items are any Items having an original contract value equal to or in excess of 10 percent of the ORIGINAL Total Contract Price or 20 percent of the ORIGINAL Total Price for Port Improvement Program projects. The original contract value of a Pay Item equals the per unit price bid for said Pay Item multiplied by the estimated quantity of such item contained in the Proposal Form. All other Pay Items shall be considered Minor Pay Items. Minor Pay Items are not eligible for any adjustment in unit price regardless of how much the total quantity varies from the quantity contained in the Proposal.

When the Owner or the Contractor requests a renegotiated unit price for the component items in excess of 125 percent of the work for Major Pay Items, the Contractor shall furnish a breakdown of the cost satisfactory to the Owner for approval, for the proposed adjusted unit price, in accordance with C through L below. The basis for the adjustment will be agreed upon prior to the performance of the work. If the basis cannot be agreed upon, the component item will be paid on a Force Account Payment basis as specified in C through L below.

When a Major Item experiences a component decrease to below 75% of the original component quantity, the actual quantity of work performed may be paid at an adjusted price, as agreed upon with the Contractor and approved by the Owner; however, total compensation will not exceed the component item's original value. Component item value is defined as the original component quantity multiplied by the contract component unit price. The Contractor shall furnish a breakdown of the cost satisfactory to the Owner for review, for the proposed adjusted unit price, in accordance with C through L below. The basis for the adjustment will be agreed upon prior to the performance of the work. If the basis cannot be agreed upon, the work will be paid on a Force Account Payment basis as specified in C through L below.

A Lump Sum price for Extra Work shall be mutually determined by the Contractor and the Owner. The Contractor shall furnish a breakdown of the cost satisfactory to the Owner for review, of the proposed lump sum, in accordance with C through L below. The basis for the adjustment will be agreed upon prior to the performance of the work. If the basis cannot be agreed upon, the work will be paid on a Force Account Payment as specified in C through L below.

C. FORCE ACCOUNT PAYMENT

If the method or amount of payment cannot be agreed upon prior to beginning the work, and the Owner directs in writing that the work be done on a force Account payment basis, the Contractor shall furnish labor, equipment, and materials necessary to complete the work in a satisfactory manner and within a reasonable period of time. The total cost for labor, material, equipment, bonds, insurance, and tax as provided below, together with applicable markups constitute full compensation for all direct and indirect costs (including overhead) and profit, and are deemed to include all items of expense not specifically designated.

D. QUOTATIONS FOR PROPOSED MODIFICATIONS

The Owner's request for quotation on a proposed modification shall not be considered authorization to proceed with the work prior to issuance of a formal Modification Order, unless directed otherwise in writing by the Owner. Nor shall such request constitute justification for a delay or a timely extension under the Contract.

The Contractor's quotation for a proposed modification shall be supplied to the Owner in writing, and shall be submitted on the form required by the Owner. The quotation shall be considered firm for a period not less than sixty (60) days from the date of the Contractor's submittal. The Contractor shall submit a written quotation for a proposed modification not later than two (2) weeks after being requested to provide such quotation, unless the Owner allows more time. Time for submitting quotations shall not be cause for a delay or time extension under the Contract.

E. GENERAL

Any compensation paid under a Modification Order shall comprise the total compensation due the Contractor for the work or modification defined in the Modification Order. By signing the Modification Order, the Contractor acknowledges and agrees that the stipulated compensation includes payment for all work contained in the Modification Order, plus all payment for the interruption of schedules, extended overheads, delay and all impact or ripple effect. The signing of other Modification Order shall indicate that the Modification Order constitutes full mutual accord and satisfaction for the change, and that the time and/or cost under the Modification Order constitutes the total equitable adjustment owed the Contractor as a result of the change. No further claim or modification for any foreseeable cause shall arise out of or as a result of a signed Modification Order.

When Work that is paid on a Force Account basis is performed by forces other than the Contractor's organization, the Contractor shall reach an agreement with such other forces as to the distribution of payments made by the Owner for such Work. Additional payment therefor will not be made by reason of the performance of the Work by a Subcontractor or other forces.

It is understood that Force Account payments pursuant to the terms of the Contract are contractual in nature only and are not to be used for any other purpose. More specifically, but not by way of limitation, the Force Account provisions of this Contract are not to be used to prove damages in a court of law in an action for breach of Contract pursuant to the provisions of the New Jersey Contractual Liability Act.

Force Account payment will be based on the following:

F. LABOR

For all necessary labor and foremen in direct charge of the specific operations, whether the employer is the Contractor, Subcontractor, or another, the Contractor shall receive the rate of wage (or scale) actually paid as shown in its certified payrolls for each and every hour that said labor and foremen are actually engaged in such Work.

The Contractor shall receive the actual costs paid to, or on behalf of, workers by reason of health and welfare benefits or other benefits, when such amounts are required by collective bargaining agreements or other employment contracts generally applicable to the classes of labor employed on the Work.

G. BOND, INSURANCE, AND TAX

For bond premiums; property damage, liability, and workers compensation insurance premiums; unemployment insurance contributions; and social security taxes on the Force Account work, the Contractor shall receive the actual incremental cost thereof, necessarily and directly resulting from the Force Account work. The Contractor shall furnish satisfactory evidence of the rate or rates paid for such bond, insurance, and tax.

H. MATERIALS

The Owner reserves the right to furnish such materials as it deems advisable, and the Contractor shall have no claims for costs and markup on such materials.

Only materials furnished by the Contractor and necessarily used in the performance of the Work will be paid for. Sales tax will not be paid on materials which, qualify for an exemption under the Sales and Use Tax Act and the regulations issued thereunder, regardless of whether the exemption is used. The cost of such materials shall be the cost to the purchaser, whether Contractor, Subcontractor, or other forces from the supplier thereto, together with transportation charges actually paid by it, except as follows:

- (1) If a cash or trade discount by the actual supplier is offered or available to the purchaser, it shall be credited to the State notwithstanding the fact that such discount may not have been taken.
- (2) If materials are procured by the purchaser by any method which is not a direct purchase from and a direct billing by the actual supplier to such purchaser, the cost of such materials shall be the price paid to the actual supplier as determined by the Engineer, plus the actual costs, if any, incurred in the handling of such materials.
- (3) If the materials are obtained from a supply or source owned wholly or in part by the purchaser, the cost of such materials shall not exceed the price paid by the purchaser for similar materials furnished from said source on Pay Items or the current wholesale price for such materials delivered to the job site, whichever price is lower.
- (4) If the cost of such materials is, in the opinion of the Engineer, excessive, then the cost of such materials shall be the lowest current wholesale price at which such materials are available in the quantities concerned, delivered to the job site, less any discounts as provided in Item a above.
- (5) If the Contractor does not furnish satisfactory evidence of the cost of such materials from the actual supplier thereof, the cost will be determined in accordance with Item d above.

I. EQUIPMENT AND PLANT**(1) Contractor Owned Equipment and Plant**

The hourly rates for Contractor owned equipment and plant will be determined from the applicable volume of the Rental Rate Blue Book (referred to hereafter as the "Blue Book"), published by Nielsen/DATAQUEST, Inc. of Palo Alto, California.

The Blue Book will be used in the following manner:

- a. The hourly rate will be determined by dividing the monthly rate by 176. The weekly, hourly, and daily rates will not be used.
- b. The number of hours to be paid for will be the number of hours that the equipment or plant is actually used on a specific Force Account activity.
- c. The current revisions will be used in establishing rates. The current revision applicable to specific Force Account work is as of the first day of work performed on that Force Account work and that rate applies throughout the period the Force Account work is being performed.
- d. Area adjustment will be made. Equipment life adjustment will be made in accordance with the rate adjustment tables.
- e. Overtime shall be charged at the same rate indicated in Item (a) above.
- f. The estimated operating costs per hour will be used for each hour that the equipment or plant is in operation on the Force Account work. Such costs do not apply to idle time regardless of the cause of the idleness.
- g. Idle time for equipment will not be paid for, except where the equipment has been held on the Project site on a standby basis at the request of the Engineer and, but for this request, would have left the Project site. Such payment will be made at one-half (.5) the rate established in Item (a) above.
- h. The rates established above include the cost of fuel, oil, lubrication, supplies, small tools, necessary attachments, repairs, overhaul and maintenance of any kind, depreciation, storage, overhead, profits, insurance, all costs (including labor and equipment) of moving equipment or plant to, on, and away from the site, and all incidentals.
- i. Operator costs will be paid only as provided in Subheading a above.

All equipment shall, in the opinion of the Engineer, be in good operating condition. Equipment used by the Contractor shall be specifically described and be of suitable size and suitable capacity required for the work to be performed. In the event the Contractor elects to use equipment of a higher rental value than that suitable for the Work, payment will be made at the rate applicable to the suitable equipment. The equipment actually used and the suitable

equipment paid for will be made a part of the record for Force Account work. The Engineer will determine the suitability of the equipment. If there is a differential in the rate of pay of the operator of oversize or higher rate equipment, the rate paid for the operator will be that for the suitable equipment.

If a rate is not established in the Blue Book for a particular piece of equipment or plant, a monthly rate will be computed on the basis of 6% of the manufacturer's list price for sale (new) of such equipment; the hourly rate in this case will be determined by dividing the monthly rate by 160, when actually operation, and by 352, when at work site but not operating, with no percentage added. For equipment used for maintenance and protection of traffic (signs, flashers, barricades, drums etc.), with no rate listed in the Rental Rate Blue Book, use a daily rate computed on the basis of 6% of the manufacturer's list price for the sale (new) of this equipment, divided by 22, with no percentage added.

The above provisions apply to the equipment and plant owned directly by the Contractor or by entities which are divisions, affiliates, subsidiaries, or in any other way related to the Contractor or its parent company.

(2) Rented Equipment and Plant

In the event that the Contractor does not own a specific type of equipment or plant and must obtain it by rental, the Contractor shall inform and obtain approval from the Engineer of the need to rent the equipment and of the rental rate for that equipment prior to using it on the Work. The Contractor will be paid the actual rental for the equipment for the time that the equipment is actually used to accomplish the Work, provided that rate is reasonable, plus the cost of moving the equipment to, on, and away from the Project site. The Contractor shall provide a copy of the paid receipt or canceled check for the rental expense incurred.

K. PROFIT

Profit shall be computed at five percent (5%) of the following:

- (1) Total material cost (bare cost FOB).
- (2) Total direct labor cost (actual hours worked multiplied by the regular hourly rate).

L. OVERHEAD

Overhead is defined to include the following:

- (1) All salaries and expenses of executive officers, supervising officers, or supervising employees;
- (2) All clerical or stenographic employees;
- (3) All charges for minor equipment, such as small tools, including shovels, picks, axes, saws, bars, sledges, lanterns, jacks, cables, pails, wrenches, and other miscellaneous supplies and services; and
- (4) All drafting room accessories such as paper, tracing cloth, and blueprinting.

Overhead costs for Force Account work shall be computed at ten percent of the following:

- (1) Total material cost (bare cost FOB).
- (2) Total direct labor cost (actual hours worked multiplied by the regular hourly rate).
- (3) Specific extraordinary overhead expenses, such as hiring of additional supervisory personnel or the use of special minor equipment (as defined above), which the Contractor has to purchase specifically for the Force Account, may be allowed. In such instances, the Contractor will be paid only the reasonable costs of such extraordinary overhead expenses provided the Engineer has agreed to such costs prior to their being incurred.
- (4) Total fringe benefits on total direct labor cost as computed above.

The Contractor will be allowed an additional ten percent (10%) for overhead on the total amount of all work performed by the Subcontractors.

M. RECORDS

The Contractor shall maintain his records in such a manner as to provide a clear distinction between the direct costs of Work paid for on a Force Account basis and the costs of other operations.

From the above records, the Contractor shall furnish to the Engineer completed daily Force Account work reports for each day's work to be paid for on a Force Account basis. Said daily Force Account work reports shall be signed by the Contractor and submitted daily.

The daily Force Account work reports shall be detailed as follows:

- (1) Name, classification, date, daily hours, total hours, rate, and extension for each worker and foreman.
- (2) Designation, dates, daily hours, total hours, rental rate (including a copy of the Blue Book pages used), and extension for each unit of machinery and equipment.
- (3) Quantities of materials, prices, and extensions.
- (4) Transportation of materials.
- (5) Cost of bonds; property damage, liability, and workers compensation insurance premiums; unemployment insurance contributions; and social security taxes.

Material charges shall be substantiated by valid copies of vendor's invoices. Such invoices shall be submitted with the daily Force Account work reports, or if not available, they shall be submitted with subsequent daily Force Account work reports. Should said vendor's invoices not be submitted within 60 days after the date of delivery of the material, or within 15 days after the Completion, whichever occurs first, the Owner reserves the right to establish the cost of such materials at the lowest current wholesale prices at which said materials are available, in the quantities concerned, delivered to the location of Work, less any discounts provided in Subheading H (1) above.

The Engineer's records will be compared with the completed daily Force Account work reports furnished by the Contractor, and any necessary adjustments will be made. When these daily Force Account work reports are agreed upon and signed by both parties, said reports become the basis of payment for the work performed but do not preclude subsequent adjustment based on a later audit by the Owner.

The Contractor's cost records pertaining to work paid for on a Force Account basis shall be open to inspection or audit by representatives of the Owner, during the life of the Contract and for a period of not less than three (3) years after Acceptance thereof, and the Contractor shall retain such records for that period. Where payment for materials or labor is based on the cost thereof to forces other than the Contractor, the Contractor shall ensure that the cost records of such other forces are open to inspection and audit by representatives of the Owner on the same terms and conditions as the cost records of the Contractor. If an audit is to be commenced more than 60 days after Acceptance, the Contractor will be provided a reasonable notice of the time when such audit is to begin. In case all or a part of such records are not made so available, the Contractor understands and agrees that any items not supported by reason of such unavailability of the records will not be allowed, or if payment therefore has already been made, the Contractor shall refund to the Owner the amount so disallowed.

N. PARTIAL PAYMENT FOR COST REIMBURSEMENT

To receive partial payments and final payment for Force Account Payment work, the Contractor shall submit to the Engineer detailed and documented verification of the Contractor's and any of the Subcontractors' actual costs incurred by the cost reimbursement work as set forth in M above. Such costs shall be submitted within thirty days (30) after said work has been satisfactorily completed.

179. PAYMENT FOR CONTRACTOR'S EXPENSES DURING DELAYS

If the Engineer finds that the Work was delayed on the entire Contract or any part thereof, because of conditions beyond the control and not the fault of the Contractor for causes as to which the provisions of the Contract authorize compensation, the Contractor will be paid its expenses during that period of delay by Change Order in the following manner:

A. LABOR

For all necessary nonproductive labor and foremen in direct charge of specific operations who must remain on the Project during such periods of delay due to collective bargaining contracts or other reasons approved by the Engineer, the Contractor is to receive the prevailing rate of wage as shown in its certified payrolls. The Contractor is also to receive the actual costs paid to, or in behalf of, workers by reason of health and welfare benefits, pension fund benefits, or other benefits, when such amounts are required by collective bargaining agreements or other employee contracts generally applicable to the classes of labor employed on the Work.

B. BOND, INSURANCE, AND TAX

For bond premiums; property damage, liability, and, workers compensation insurance premiums; unemployment insurance contributions; and social security taxes during the period of delay, the Contractor is to receive the actual incremental cost thereof, necessarily and directly resulting from the delay. The Contractor shall furnish satisfactory evidence of the rate or rates paid for such bond, insurance, and tax.

C. IDLE EQUIPMENT

For any idle machinery or special equipment other than small tools which must remain on the Project site, with approval of the Engineer, during delays, the Contractor is to receive compensation at one-half (.5) the rate calculated pursuant to Subheading 4 of the fifth paragraph of GENERAL CONDITIONS Article "PAYMENT FOR MODIFICATIONS."

Should the Engineer determine that it is not necessary for machinery or equipment to remain on the Project during delays, the Contractor is to receive transportation costs to remove the machinery or equipment and return it to the Project at the end of the delay period.

The time for which such compensation will be paid is the actual normal working time during which such delay condition exists, which in no case exceeds eight (8) hours in any one (1) day or 40 hours per week.

The days for which compensation will be paid are the calendar days, excluding Saturdays, Sundays, and holidays, during the existence of such delay.

D. MISCELLANEOUS

The Contractor further receives an amount equal to ten percent of the sum of the above items, which is full compensation for overhead, general superintendence, or other costs attributed to the delay for which no specific allowance is herein provided. Payment under this Article constitutes full compensation for all items of expense related to such delay.

E. PROFIT

Profit is not allowed under this Article.

F. RECORDS

Payment will not be made for delays until the Contractor has furnished the Engineer with duplicate itemized statements of the cost as hereinabove specified and detailed as follows:

1. Name, classification, date, daily hours, total hours, rate, and extension for each worker and foreman.
2. Designation, dates, daily hours, total hours, rental rate, and extension for each unit of machinery and equipment.
3. Transportation costs.
4. Cost of bonds; property damage, liability, and workers compensation insurance premiums; unemployment insurance contributions; and social security taxes.

The Engineer will compare the Owner's records with completed daily reports furnished by the Contractor and make any necessary adjustments. When these daily reports are agreed upon and signed by both parties, said reports become the basis of payment for the expenses incurred, but do not preclude subsequent adjustment based on a later audit by the Owner.

The Contractor's cost records pertaining to expenses under this Article shall be open to inspection or audit by representatives of the Owner during the life of the Contract and for a period of not less than three (3) years after Acceptance thereof, and the Contractor shall retain such records for that period. Where payment for materials, equipment, or labor is based on the cost thereof to forces other than the Contractor, the Contractor shall make every reasonable effort to ensure that the cost records of such other forces are open to inspection and audit by representatives of the Owner on the same terms and conditions as the cost records of the Contractor. Payment for such cost may be deleted if the records of such third parties are not made available to the Owner's representatives. If an audit is to be commenced more than 60 days after Acceptance, the Contractor is to be provided with a reasonable notice of the time when such audit is to begin. In case all or a part of such records are not made so available, the Contractor understands and agrees that any items not supported by reason of such unavailability of the records will not be allowed, or if

payment therefor has already been made, the Contractor shall refund to the Owner the amount so disallowed.

180. PARTIAL PAYMENTS

A. GENERAL

Nothing contained in this Article shall be construed to affect the right of the Owner to reject the whole or any part of the work found to be defective. All estimated quantities of work for which partial payments have been made are subject to review and correction prior to final payment. Payments by the Owner and acceptance by the Contractor or partial payments based on periodic estimates of quantities of work executed shall not, in any way, constitute acceptance of the estimated quantities used as the basis for computing the amounts of the partial payments.

B. ESTIMATE FOR PARTIAL PAYMENT

All requests for partial payment must be received by the Owner no later than the 25th day of each calendar month. The Contractor shall submit to the Construction Manager, on the form provided, an estimate based on the approved cost breakdown of the amount earned for the separate portions of the work and request payment. The Construction Manager must approve the request for partial payment prior to forwarding to the Owner. Therefore, the Contractor shall allow a minimum of seven (7) calendar days for the approval of the request by the Construction Manager. As used in this Article, the words "amount earned" mean the value, on the date of the estimate for partial payment, of the work completed in accordance with the Contract Documents, including the value of approved materials delivered to and stored at the project site suitably stored and protected at an approved storage area prior to incorporation into the work. If the Contractor's estimate of the amount earned conforms to the Construction Manager's evaluation, the Construction Manager will make recommendation to the Engineer for payment. The Construction Manager's approval does not constitute approval by the Engineer. The Engineer retains the right to overrule the Construction Manager with regard to approval of the request for partial payment.

If the Contractor's estimate of the amount earned does not agree with the Construction Manager's and the Engineer's evaluations, the Contractor shall submit a revised estimate that will meet with their approvals; or, as an alternative, the Engineer will estimate the percentage of work completed and submit to the Owner and Contractor his recommendation as to the amount earned for partial payment.

Partial Payment requests will not be processed unless ALL of the following criteria have been met:

1. The requirements of the preceding two (2) paragraphs have been fulfilled.
2. The Contractor has fulfilled ALL the requirements contained in the Schedule and Sequence of Operations in the Specifications, for the period.

C. RETAINAGE

Retainage from the estimates of the amounts earned will be as described below.

The Owner will retain ten percent (10%) of the amount of each such estimate until fifty percent (50%) of the work has been completed. At fifty percent (50%) completion, further partial payments will be made in full to the Contractor and no additional amounts will be

retained unless the Engineer certifies that the work is not proceeding satisfactorily, but amounts previously retained will not be paid to the Contractor. At fifty percent (50%) completion or any time thereafter when the progress of the work is not satisfactory, additional amounts may be retained, but in no event will the total retainage be more than ten percent (10%) of the value of the work completed. Upon the Engineer's Certification of Substantial Completion, an amount retained may be paid to the Contractor. When the work has been substantially completed, except for work which cannot be completed because of weather conditions, lack of materials, or other reasons which in the judgment of the Owner are valid reasons for non-completion, the Owner may make additional payments, retaining at all times an amount sufficient to cover the estimated cost of the work still to be completed, or in the alternative may pay out the entire amount retained and received from the Contractor guarantees in the form of a bond or other collateral sufficient to ensure completion of the work. For the purposes of this Article, estimates will include any fabricated or manufactured materials and components specified and delivered to the work or properly stored and suitable for incorporation in the work embraced in the Contract.

D. QUALIFICATION FOR PARTIAL PAYMENT FOR MATERIALS DELIVERED OR STORED

Qualification for partial payment for materials delivered or suitably stored, but not yet incorporated into the work shall be as described below.

Materials, as used herein, shall mean fabricated and manufactured material and equipment. Only those materials for which the Contractor can transfer clear title to the Owner will be qualified for partial payment.

To receive partial payment for materials on hand at the jobsite or which are stockpiled in the vicinity of the jobsite at a location approved by the Engineer and that are adequately insured and protected through appropriate security measures, but not incorporated in the work, the Contractor shall submit to the Engineer, at the time of requesting partial payment, a list of such materials. The Engineer, after confirming that such materials are on hand or stockpiled and are adequately insured and protected will recommend to the Owner the items for which partial payment is to be made. The Contractor's actual net cost for the materials must be supported by paid invoices of suppliers. Final payment shall be made only for materials actually incorporated in the work and, upon acceptance of the work, all materials remaining for which partial payments had been made shall revert to the Contractor, unless otherwise agreed, and partial payments made for these items shall be deducted from the final payment or the work.

Partial payments for undelivered, specifically manufactured equipment to be incorporated into the work, excluding "off the shelf" or catalog items, will be made to the Contractor for payment to the equipment manufacturer when all of the following conditions exist.

1. The equipment is so designated in the Specifications.
2. The equipment to be specifically manufactured for the project could neither be readily utilized on nor diverted to another job, and,
3. A fabrication period of more than six (6) months is anticipated.

The first payment for undelivered, specifically fabricated equipment will be made following approval of the shop drawings for the equipment, but in no case will payment exceed fifteen percent (15%) of the quoted price of the equipment. Thereafter monthly payments will be made based on the progress of fabrication a determined by the Engineer, but in no case

will the total payments, prior to delivery exceed seventy five percent (75%) of the quoted price of the equipment.

E. PAYMENT

After deducting the retainages and the amount of all previous partial payments made to the Contractor, the amount earned as of the current month will be made payable to the Contractor as follows:

Not later than the 15th of each calendar month, the Owner will make partial payment to the Contractor on the basis of the Engineer's recommended estimate of the work executed during the preceding calendar month.

181. RELEASE OF LIENS OR CLAIMS

The Contractor shall indemnify and save harmless the Owner from all claims for labor and materials furnished under this Contract. Before the Owner pays the Contractor his final payment for the work, the Contractor shall submit satisfactory evidence that all persons, firms, or corporations who have done work or furnished materials under this Contract, for which the Owner may become liable under the laws of the State of New Jersey, have been fully paid or satisfactorily secured. If evidence is not furnished or is not satisfactorily secured. If evidence is not furnished or is not satisfactory, an amount shall retained from moneys due the Contractor which, in addition to any other sums that may be retained, will be sufficient, in the opinion of the Owner, to meet all liens or claims. Such sum or sums shall be retained until the liens or claims are fully discharged or satisfactorily secured.

If any lien or claim remains unsatisfied after all payments to the Contractor are made, the Contractor shall refund to the Owner all moneys that the latter may be compelled to pay in discharging such a lien or claim, including all costs and attorneys' fees.

182. FINAL PAYMENT

Upon completion of all of the work under this Contract, the Contractor shall notify the Engineer, in writing, that he has completed the work and make application for final payment. The Owner shall pay to the Contractor all moneys due him under the provisions of the Contract Documents after the following conditions have been met:

- A. The Owner has accepted the completed work, or formally waived nonconforming work to the extent of the nonconformity;
- B. The Owner has approved the Engineer's recommendation for acceptance of the work;
- C. The Contractor has complied with all the requirements set forth in each Certificate of Substantial Completion;
- D. The Contractor has furnished the Owner with a release of all claims against the Owner or the Engineer arising by virtue of this Contract other than claims in stated amounts as may be specifically accepted by the Contractor from the operation of the release;
- E. The Contractor has complied with all other provisions of the Contract Documents;
- F. Neither the final payment nor the partial payment shall operate to release the Contractor or his Sureties from any obligation under this Contract or any bond or warranty, as herein provided.

183. NO WAIVER OF RIGHTS

Neither the inspection by the Owner, through the Engineer or any employees of the same, nor any order by the Owner for payment of money, nor any payment for, or acceptance of, the whole or any part of the work by the Owner or Engineer, nor any extension of time, nor any possession taken by the Owner or his employees, shall operate as a waiver or any provision of this Contract, or any power herein reserved to the Owner, or any right to damages herein provided, no shall any waiver of any breach in this Contract be held to be a waiver of any other or subsequent breach.

184. ACCEPTANCE OF FINAL PAYMENT CONSTITUTES RELEASE

The acceptance by the Contractor of the final payment shall release the Owner and the Engineer, as representative of the Owner, from all claims and all liability to the Contractor for all things done or furnished in connection with the work, and every act of the Owner and others relating or arising out of the work. Within 30 days after Final Payment has been issued to the Contract, the Contractor shall submit to the Engineer a written acceptance of the Final Payment. The Contractor's failure to submit any written acceptance within 30 days will be construed as an acceptance of the Final Payment without exception or reservation.

185. AUDIT: ACCESS TO RECORDS

- A. The Contractor shall maintain books, records, documents and other evidence directly pertinent to performance of work under this Contract in accordance with generally accepted accounting principles and practices consistently applied. The Contractor shall also maintain financial information and data used by the Contractor in the preparation or support of the cost submissions required for this Contract, or any Modification Order or claim, and a copy of the cost summary submitted to the Owner. The Owner and appropriate representative of the federal government (if this project is funded by federal monies) or their authorized representatives shall have access, at all times during normal business hours, to such books, records, documents and other evidence for the purpose of inspection, audit and copying. The Contractor will provide proper facilities for such access and inspection during normal business hours.
- B. The Contractor agrees to make paragraph A through H of this Article applicable to this Contract and all Modification Orders or claims affecting the Contract price. The Contractor agrees to include paragraphs A through H of this Article in all his contracts and all their subcontracts in excess of \$10,000, and to make paragraphs A through H of this Article applicable to all Modification Orders and claims related to project performance.
- C. Audits conducted under this Article shall be in accordance with generally accepted auditing standards and established procedures and guidelines of the reviewing or audit agency.
- D. The Contractor agrees to the disclosure of all information and reports resulting from access to records under paragraphs A and B of this Article, to the agencies referred to in paragraph A of this Article, provided that the Contractor is afforded the opportunity for an audit exist conference, and an opportunity to comment on and submit any supporting documentation on the pertinent portions of the draft audit report, and that the final audit report will include written comments of reasonable length, if any, of the Contractor.
- E. Records under paragraphs A and B of this Article shall be maintained and made available during performance of work under this Contract until final payment, or until settlement of all disputes, claims, or litigation. In addition, those records which relate to any portion of this Contract, to any Modification Order, to any dispute, to litigation, to the settlement of claims arising out of such performance, or to costs or times to which an audit exception

have been taken, shall be maintained and made available until final payment or until final resolution of such dispute, litigation, claim or exception, whichever occurs later. As a minimum, the auditors shall have available to them the following documents:

1. Daily time sheets and foreman's daily reports.
 2. Union agreements.
 3. Insurance, welfare, and benefits records.
 4. Payroll registers.
 5. Earnings records.
 6. Payroll tax forms.
 7. Material invoices and/or requisitions.
 8. Material cost distribution worksheet.
 9. Equipment records (list of company equipment and rates).
 10. Vendors', rental agencies', and Subcontractors' invoices.
 11. Subcontractors' payment certificates.
 12. Canceled checks (payroll and vendors).
 13. Job cost report.
 14. Job payroll ledger.
 15. General ledger.
 16. Cash disbursements journal.
 17. Financial statements for all years reflecting the operations on the Project.
 18. Income tax returns for all years reflecting the operations on the Project.
 19. Depreciation records on all company equipment whether such records are maintained by the company involved, or its accountant, or others.
 20. If a source other than depreciation records is used to develop costs for the Contractor's internal purposes in establishing the actual cost of owning and operating equipment, all such other source documents.
 21. All documents which reflect the Contractor's actual profit and overhead during the years the Project was being performed and for each of the five (5) years prior to the commencement of the Project.
 22. All documents related to the preparation of the Contractor's bid including the final calculations on which the bid was based.
 23. All documents which relate to each and every claim together with all documents which support the amount of damages as to each claim.
 24. Worksheets used to prepare the claim establishing the cost components for items of the claim including, but not limited to, labor, benefits and insurance, materials, equipment, Subcontractors, and all documents which establish the time periods, individuals involved, and the hours and rates for these individuals.
- F. The right of access which this Article confers will generally be exercised with respect to financial records, on Modification Orders or claims in excess of \$10,000 affecting the price of this Contract. Such right of access may be exercised with respect to records pertaining directly to Contract performance or claims, or if the Contract is terminated for default or convenience.
- G. If the Owner determines that any price negotiated in connection with this Contract, or any cost reimbursable under this contract, was increased by any significant sums because the Contractor, or any tier Subcontractor, furnished incomplete or inaccurate cost or pricing data or data not current, then such price or cost or profit shall be reduced accordingly and the contract shall be modified in writing to reflect such reduction.
- H. Failure to agree on a reduction under this Article shall be subject to Article "DISPUTES" of these GENERAL CONDITIONS.

Page Intentionally Left Blank

SJPC-24-E7
REQUEST FOR SEALED BIDS
BUILDING B SANITARY PUMP STATION REPAIRS
AT THE BALZANO MARINE TERMINAL
SCOPE OF WORK

Background

Sanitary sewage flows from the bathrooms at the Balzano Marine Terminal are conveyed to the City of Camden gravity sewer collection system in Clinton Street by a grinder pump and force main system installed in 1987. See the attached Drawings 8 and 9 of 21 by Taylor, Wiseman & Taylor.

There are four buildings connected to this system. B Building, A Building, Shed 2, and the fleet maintenance garage. The main line is 3" ductile iron pipe, and the branch lines are 2" CPVC, Schedule 80.

Three of these pump stations have a single automatic grinder pump. The SJPC has been using Zoeller Model WD820 to replace these pumps.

Building B has a duplex wet well with two manual pumps on a motor controller. This station no longer works. The SJPC is seeking a qualified plumbing contractor to supply and install a replacement for this pump station and its related equipment. The work is divided into tasks as follows.

Scope of work

Contractor shall supply and install the following:

Include all other costs including mobilization, shop drawings, provision of a vacuum truck with operator and confined space entry trained mechanic, transportation and disposal of collected liquid waste at an approved waste handling facility, etc.

Branch Line Isolation Valve at Curb Box

Perform exploratory excavation to uncover the branch line isolation valve at the junction of the 2" CPVC and 3" DIP. Previous work stopped at a concrete slab. Close the valve.

If the valve cannot be found, install a D.I. reducing tee, 2" valve, and curb box. See attached Curb Box Detail from the plans.

Pump Station

One (1) - Zoeller Pivot Pro+ Series Control Panel. 200 Volt, 1 Ph, 60 Hz, or approved equal. Features include Red alarm beacon, Audible alarm buzzer rated to 95 db @ 2', Silence/Reset/Test toggle switch, Hand/Off/Auto toggle switches, Thermal trip indicator/ alarm for each pump, Seal fail indicator/alarm for each pump.

Three (3) - Zoeller Submersible Grinder Pumps, Model 7010. 2 HP, 200V, 1Ph, 60 Hz. 20' power cable, or approved equal. With 1.25" Vertical discharge.
Two pumps will be installed. One pump will be provided to the owner as a spare.

Three (3) - NONC Float Switches - Off, On, Lag/High-Level alarm

Two (2) – Zoeller 2" Cast Iron Full-Flow Unicheck Check Valves
Zoeller Model: 30-0152 | UPC: 053514019648, or approved equal

Install Schedule 80 PVC piping and fittings to connect pumps to existing station discharge piping. Extend piping above grade for disconnect coupling connection.

Contractor and manufacturer to confirm that all components are compatible for a properly functioning system.

Flushing Station with Air Release Valve - Type “T” (Terminal)

Beginning at the Dresser coupling, replace all existing parts of the station including the 2” air release valve, 3” valve, and flushing connection. Add a ball valve below the air release valve. Flush the 3” line.

Electrical

Provide an electrical single line diagram of the existing and proposed wiring.
Install new circuit breaker to feed the control panel.
Run conduits and pull in new conductors as needed.
Install new control panel and wire the pumps. Install floats. Install new pumps.

Perform testing to ensure proper operation of the pumping station and air relief valve.
Provide training for SJPC maintenance personnel in the correct operation and preventive maintenance of the system.

Pressure Testing of the existing 2” CPVC piping

Connect a portable air compressor capable of 135 PSI and a pressure gauge to the discharge piping in the pump station. Close isolation valve in curb box near ARV pit. Introduce air pressure to a predetermined PSI and monitor pressure gauge to test for underground leaks between the pump station and isolation valve near the ARV pit.

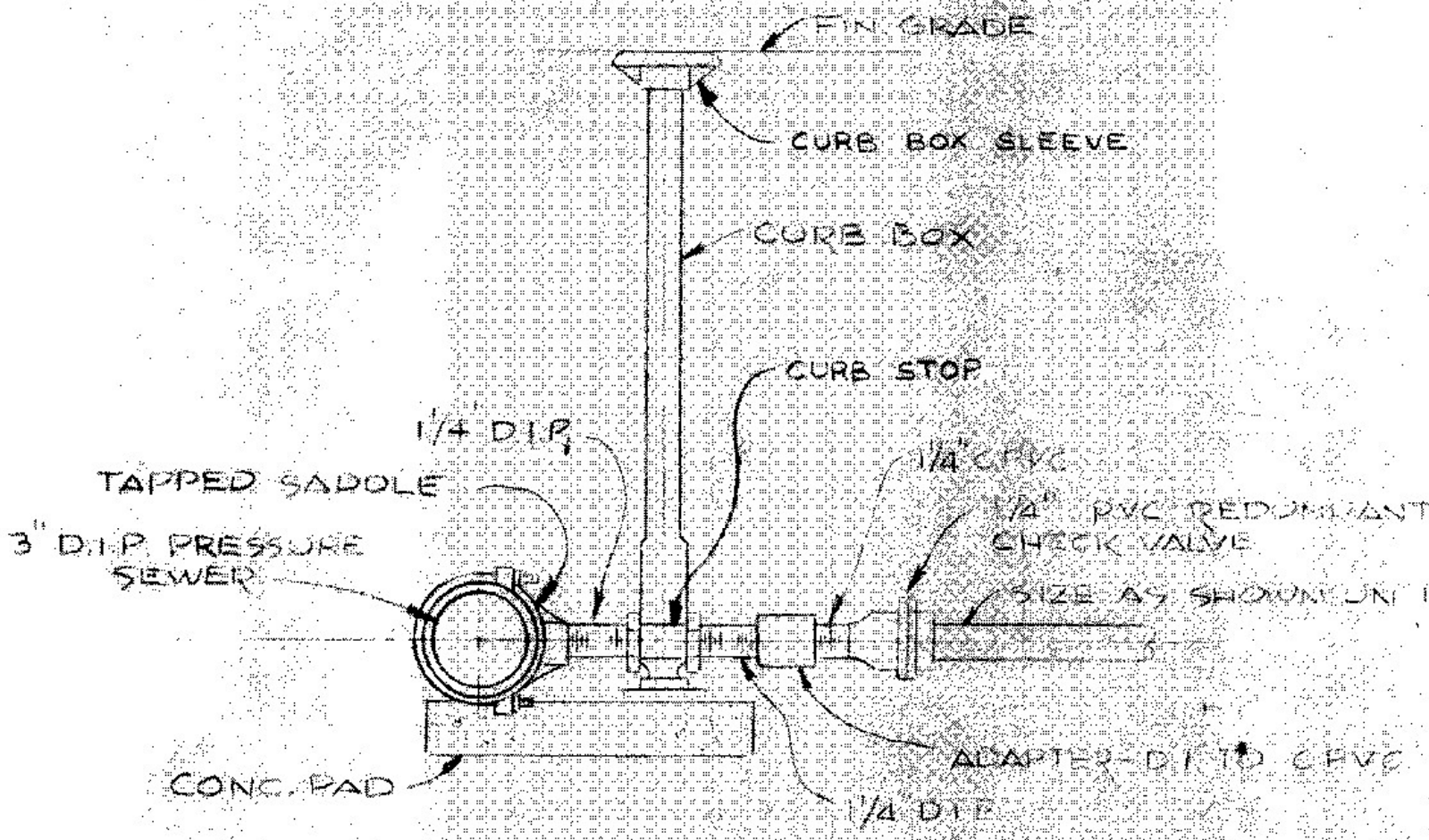

CURB BOX DETAIL

SCALE: 1/2" = 1'-0"

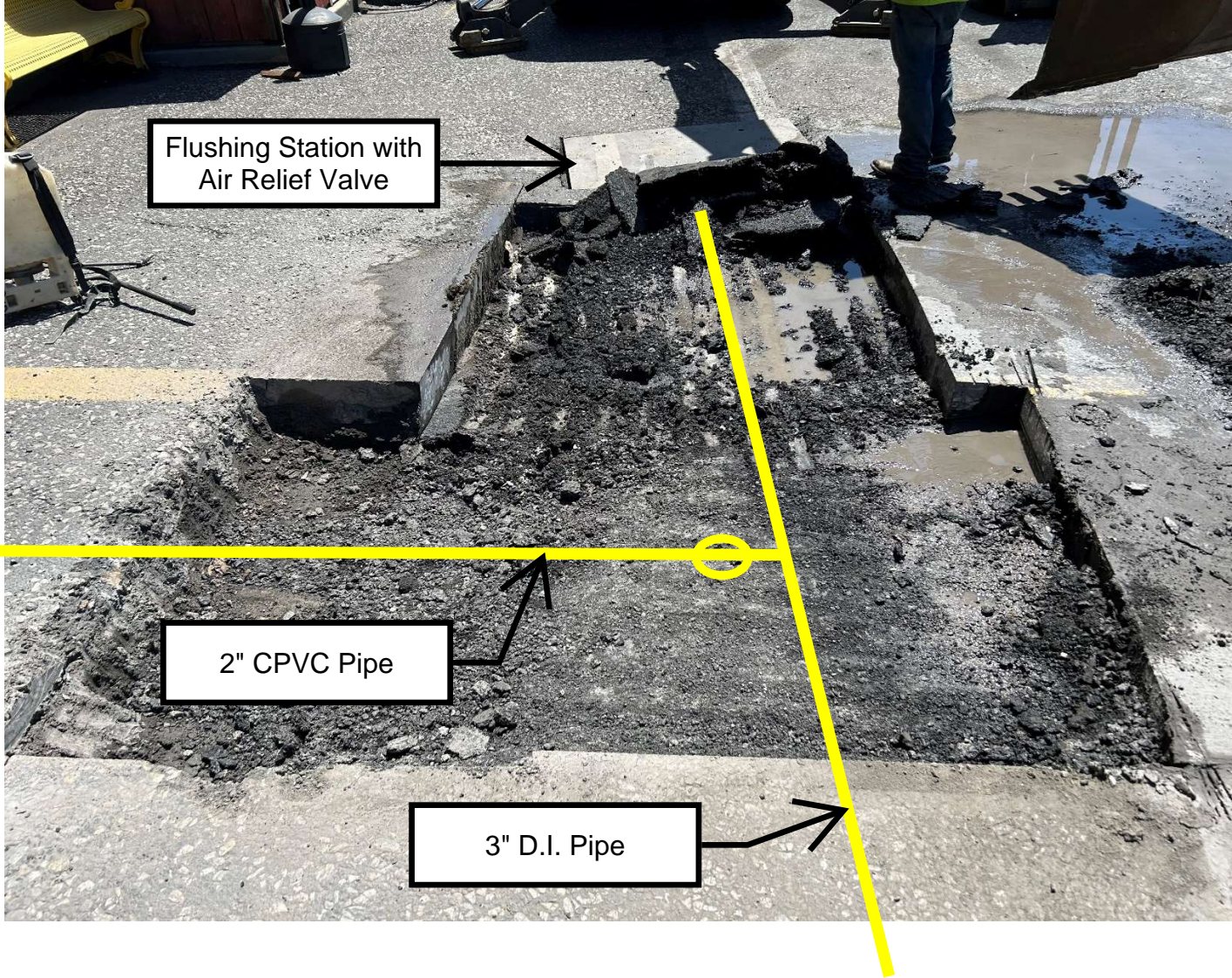

Approximate location of Curb Box

Note Flushing Station lid in the background



Existing "Canned" Pumping Station Wet Well



Existing Grinder Pump



Existing Electrical Panel



Existing Electrical Controls

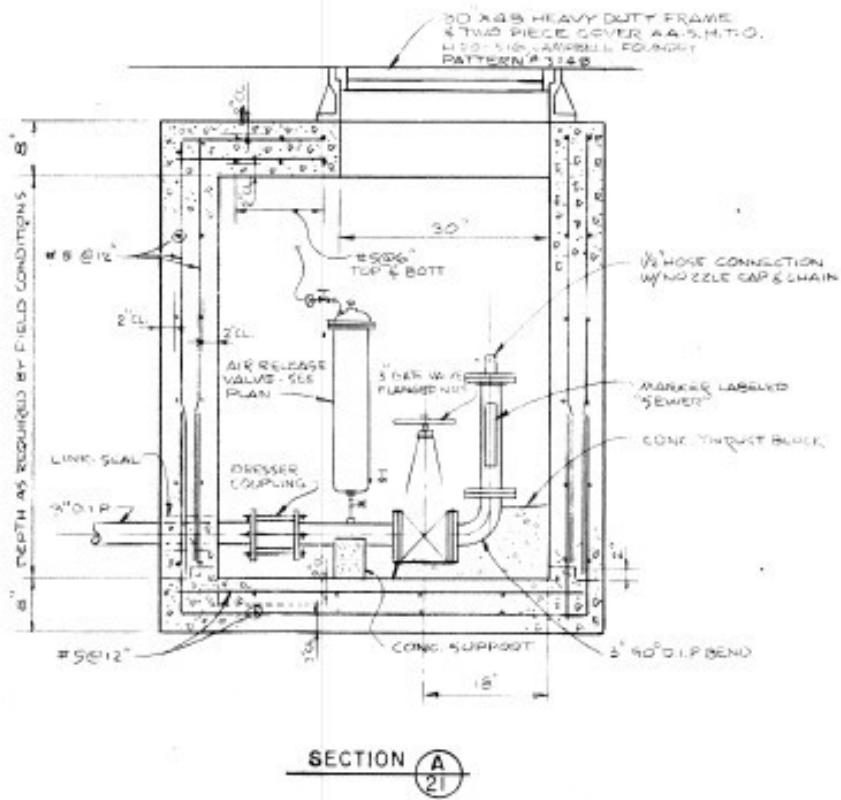
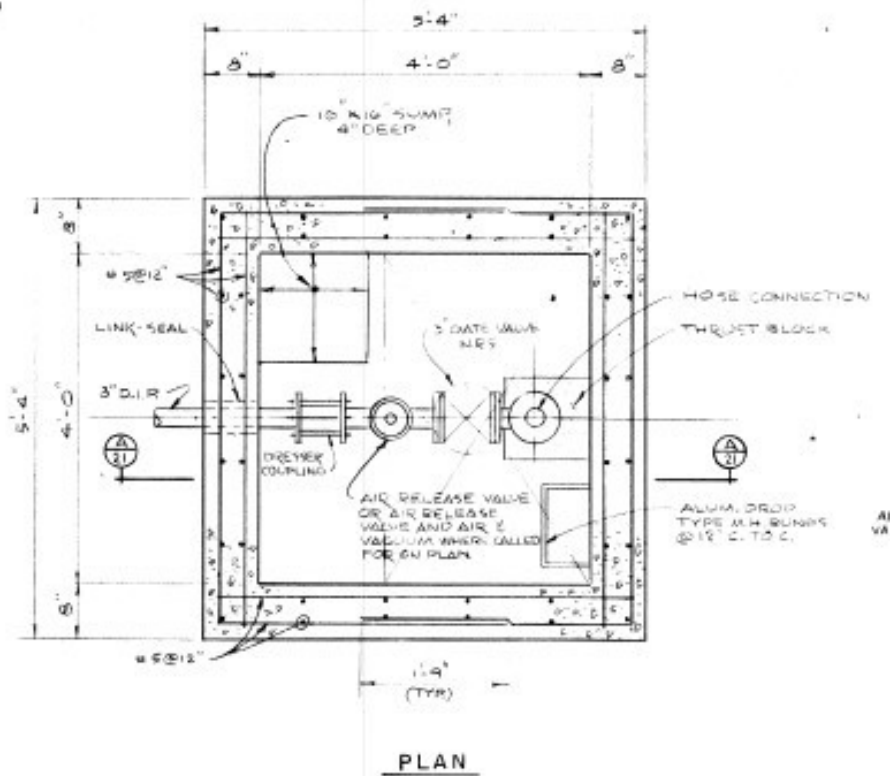

TYPE T (TERMINAL)

Flushing Station with Air Relief Valve



Flushing Station with Air Relief Valve



Flushing Station with Air Relief Valve

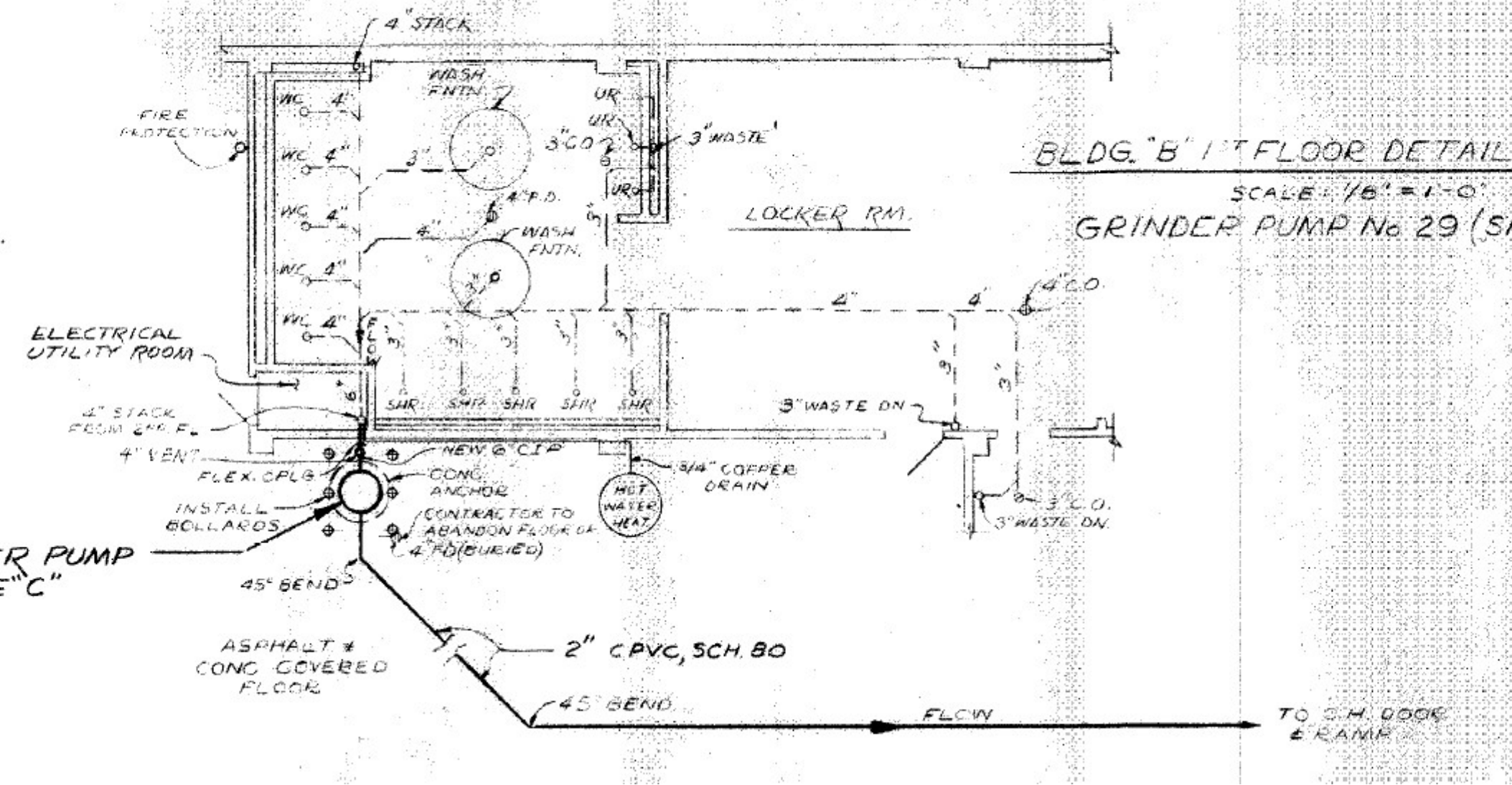

Building B Floor Plan

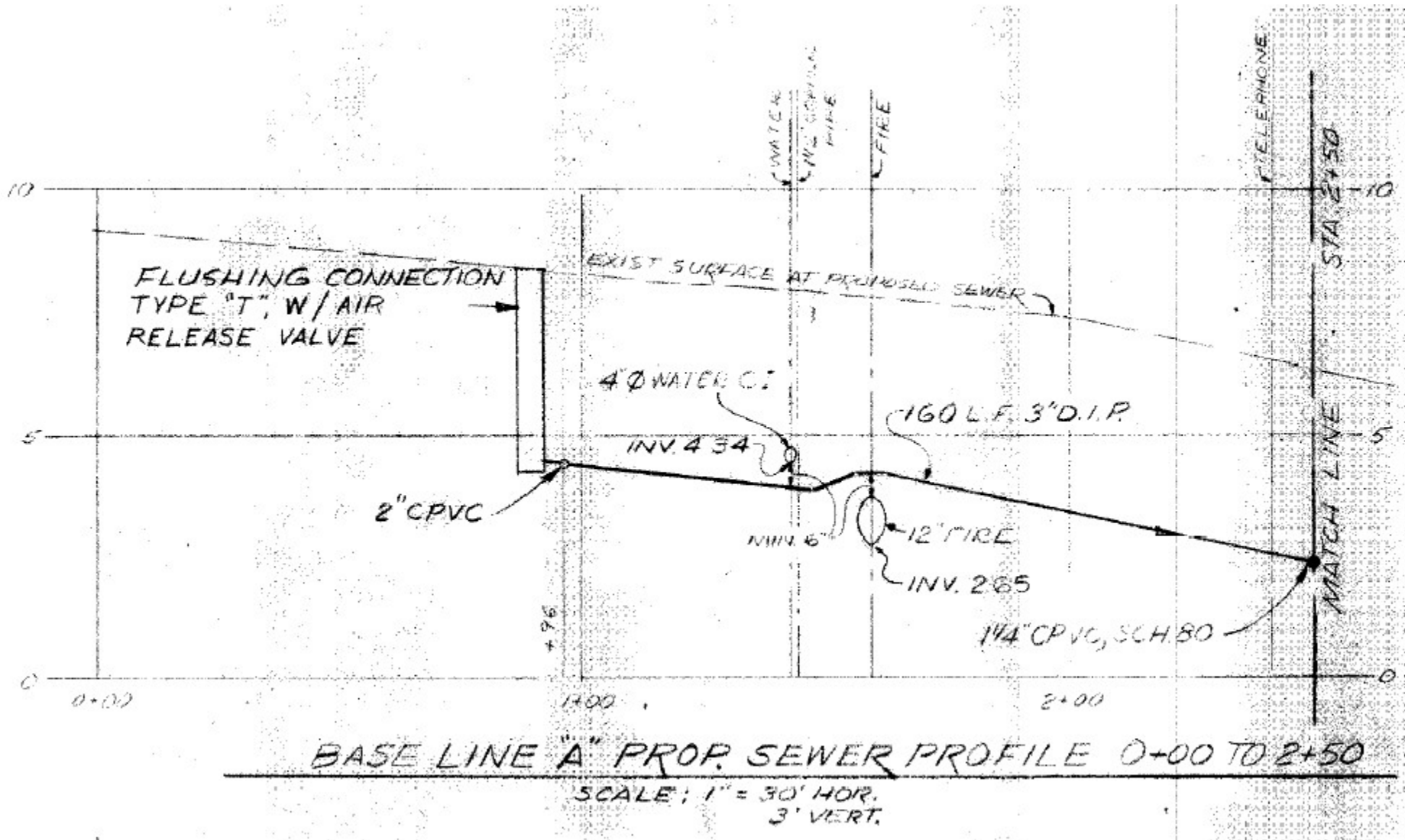

Building B Force Main Profile

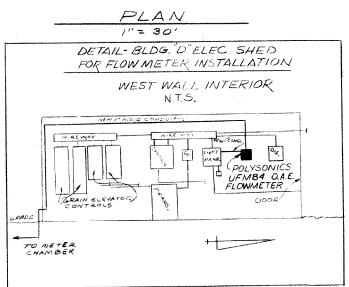
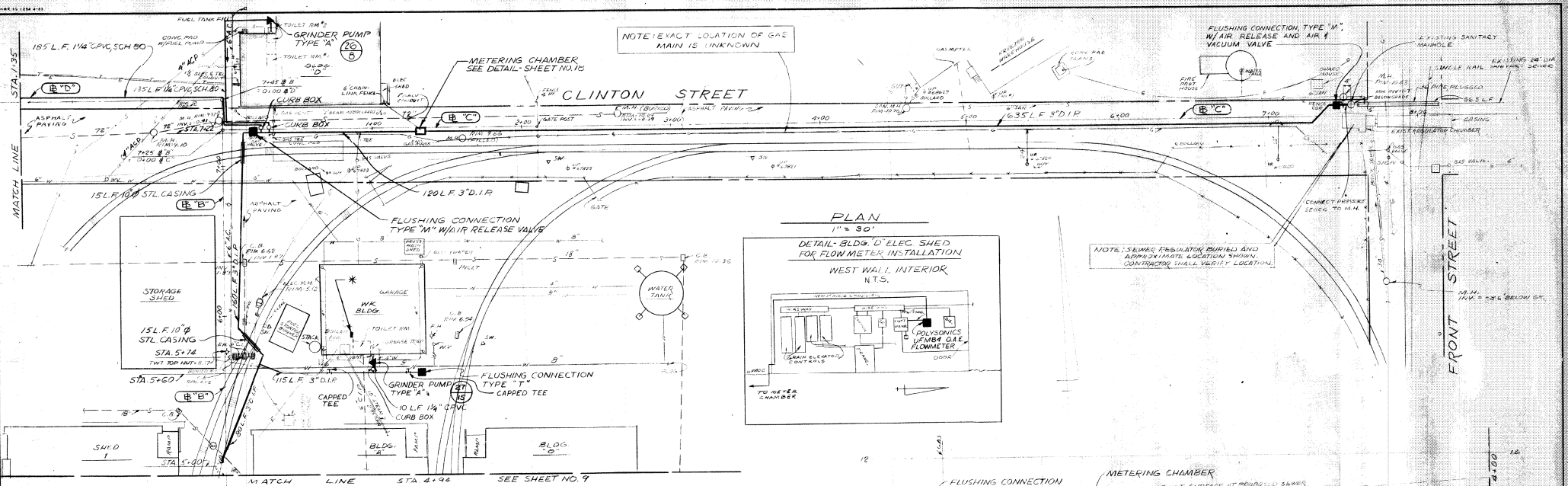

NOTE: SEWER REGULATOR BUILT AND APPROXIMATE LOCATION SHOWN. CONTRACTOR SHALL VERIFY LOCATION.

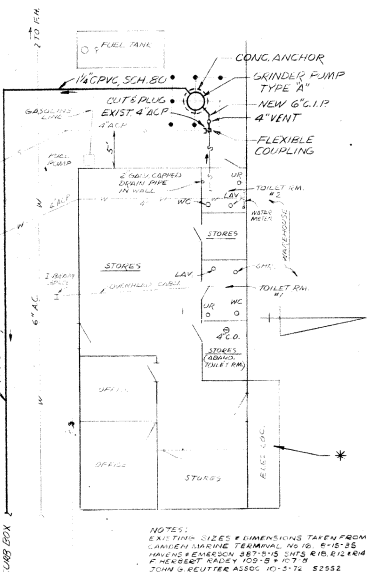
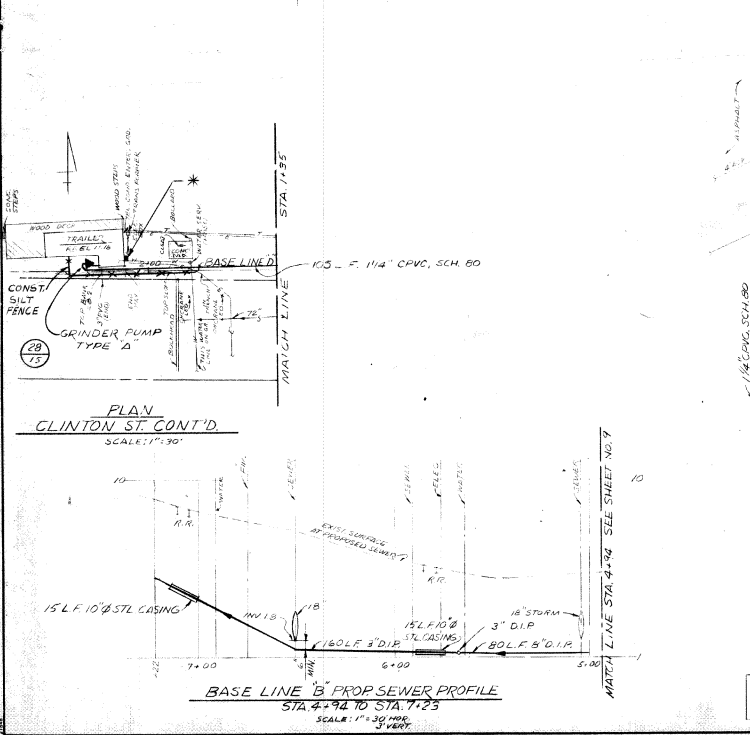

BLDG 'D' DETAIL PLAN (BECKETT)
SCALE: 1"=10'
GRINDER PUMP No. 26 (SHE)

NOTE: ALL GRINDER PUMPS TYPE "A" EXCEPT WHERE NOTED OTHERWISE

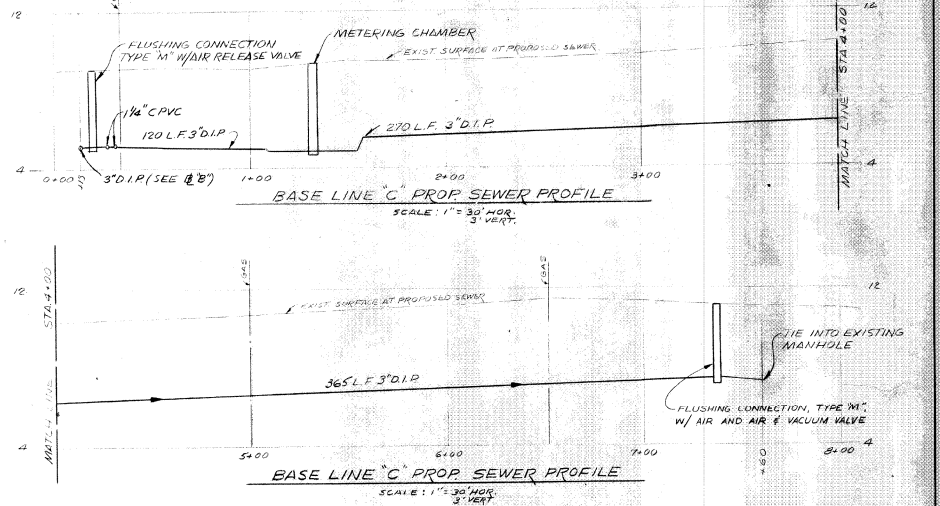

NOTE: SURVEY TAKEN BEFORE REPAVEMENT OF ROAD. DATUM USED IS U.S.C. F.G.S.

* DENOTES ELECTRICAL POWER SOURCE

APPROVED	WGF	UPT	REVISIONS	NO.	DATE
JEFFREY P. TAYLOR					
PRESSURE SANITARY SEWER SYSTEM					
SOUTH JERSEY PORT CORPORATION					
BECKETT TERMINAL, CAMDEN, NEW JERSEY					
PLAN, PROFILES & BLDG. DETAIL PLANS					
TAYLOR · WISEMAN & TAYLOR					
CONSULTING ENGINEERS · SURVEYORS					
PLANNERS · LANDSCAPE ARCHITECTS					
306 FELLOWSHIP ROAD, MOUNT LAUREL, NJ 08054					
SCALE	DATE	DATE	DATE	DATE	DATE
AS SHOWN	JULY 1987				

- NOTES**
- SEE SHEET 2 FOR GENERAL NOTES AND LEGEND.
 - ROADWAY UP TO 6" THICK ASPHALT WITH 15"± CONC. BASE WITH 2" WIRE MESH, REBAR AND CHAIRS.
 - GENERAL PLAN 1226 SEPT 1, CAMDEN MARINE TERMINAL

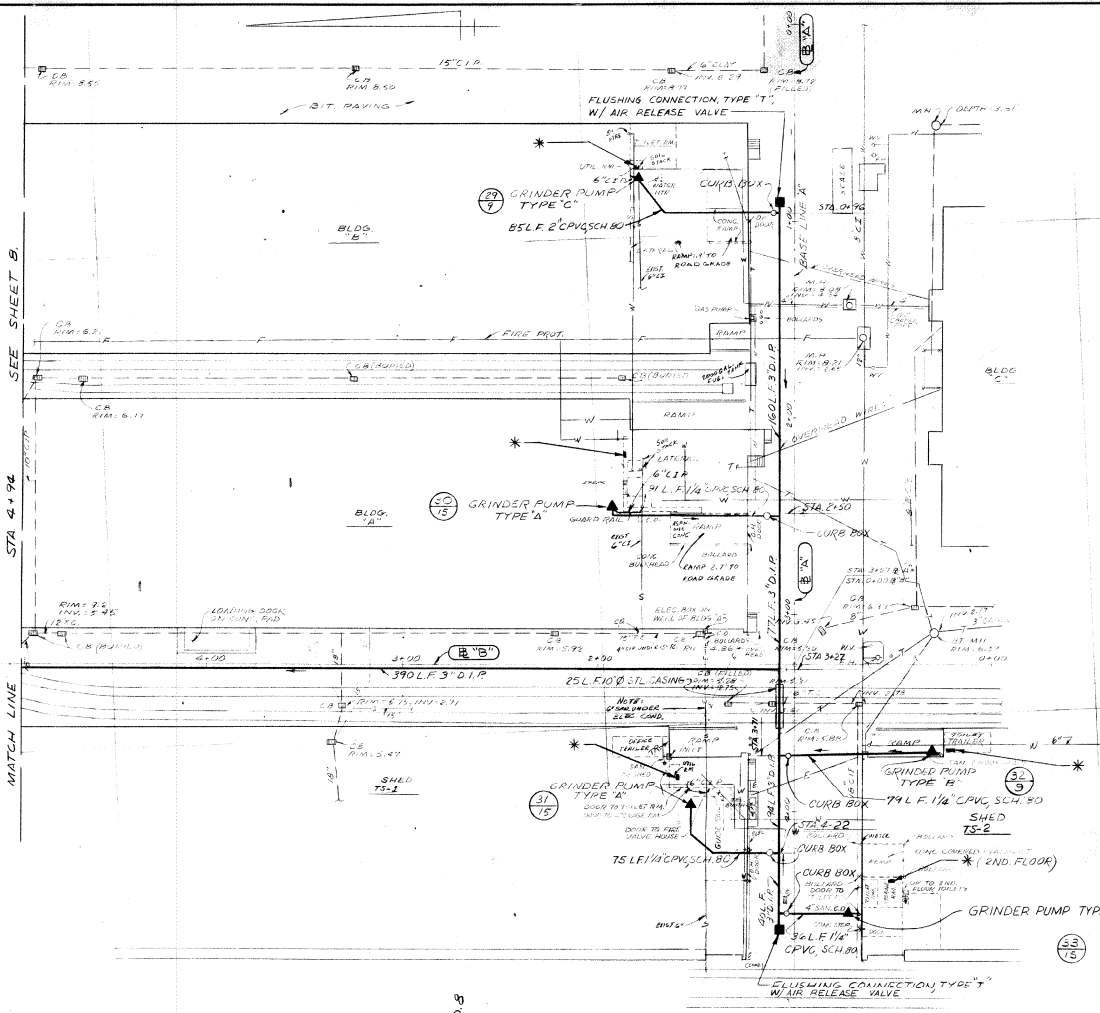

PLAN
SCALE: 1" = 30'

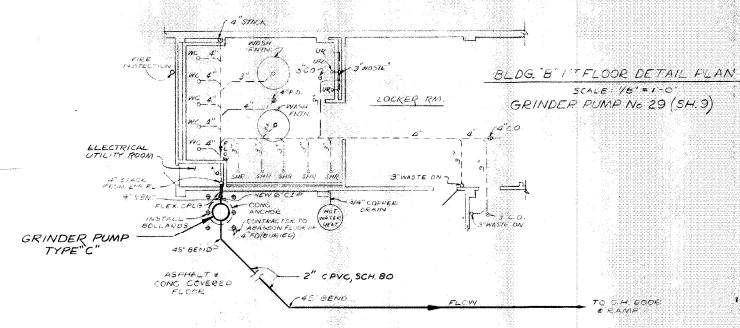

BLDG. B 1st FLOOR DETAIL PLAN
SCALE: 1/8" = 1'-0"
GRINDER PUMP No. 29 (SH. 9)

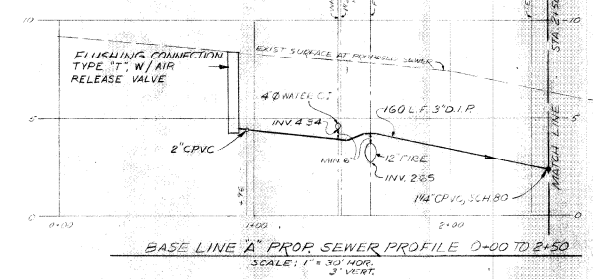

BASE LINE A PROP SEWER PROFILE 0+00 TO 2+50
SCALE: 1" = 30' HOR.
3" VERT.

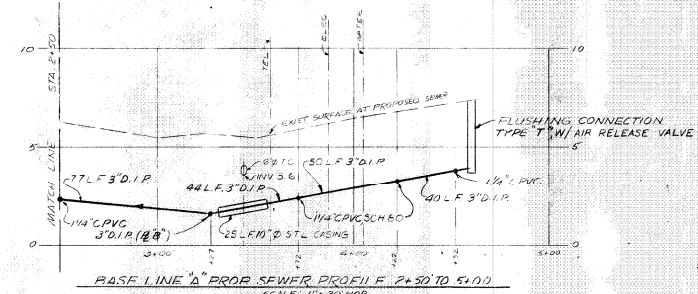

BASE LINE A PROP SEWER PROFILE 2+50 TO 5+00
SCALE: 1" = 30' HOR.
3" VERT.

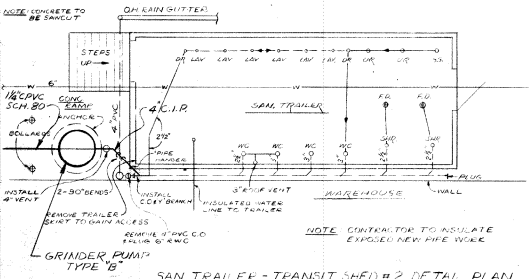

SAN TRAILER - TRANSIT SHED #2 DETAIL PLAN
SCALE: 1/4" = 1'-0"
GRINDER PUMP NO. 32

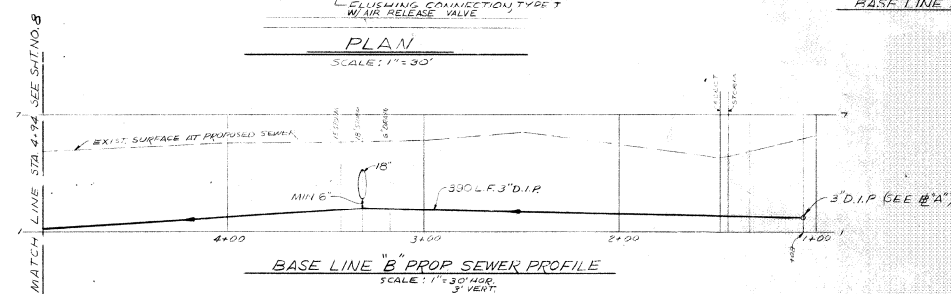

BASE LINE B PROP SEWER PROFILE
SCALE: 1" = 30' HOR.
3" VERT.

- NOTES**
- ROADWAY 16" TO 8" THICK ASPHALT WITH 15" CONCRETE BASE WITH 2 WIRE MATS, REBAR AND CHAIRS.
 - FROM PLAN 106-0-D 5.37 FEET COMMISSION GENERAL PLAN 1936 SEPT 1, CAMDEN MARINE TERMINAL ST. 6. BLDG. B ALTERATION 5-12-72 ERING, COLE ERDMAN & LEBLANC, CAMDEN MARINE TERMINAL No. 16, 6-15-35 JOHN G. REUTER ASSOC. 52552 10-3-72

DESIGNED	DRAWN	CHECKED	APPROVED	DATE	REVISIONS	NO. DATE
J.P.T.	J.P.T.	J.P.T.	J.P.T.	10/12/87		

PRESSURE SANITARY SEWER SYSTEM

JEFFREY P. TAYLOR

SOUTH JERSEY PORT CORPORATION
BECKETT TERMINAL CAMDEN, NEW JERSEY

PLAN, PROFILES & BLDG DETAIL PLANS

TAYLOR • WISEMAN & TAYLOR
CONSULTING ENGINEERS • SURVEYORS
PLANNERS • LANDSCAPE ARCHITECTS
306 FELLOWSHIP ROAD, MOUNT LAUREL, N.J. 08054

J.P.T. PROFESSIONAL ENGINEER No. 2553

* DENOTES ELECTRICAL POWER SOURCE